

MASTER  
BOOK.14

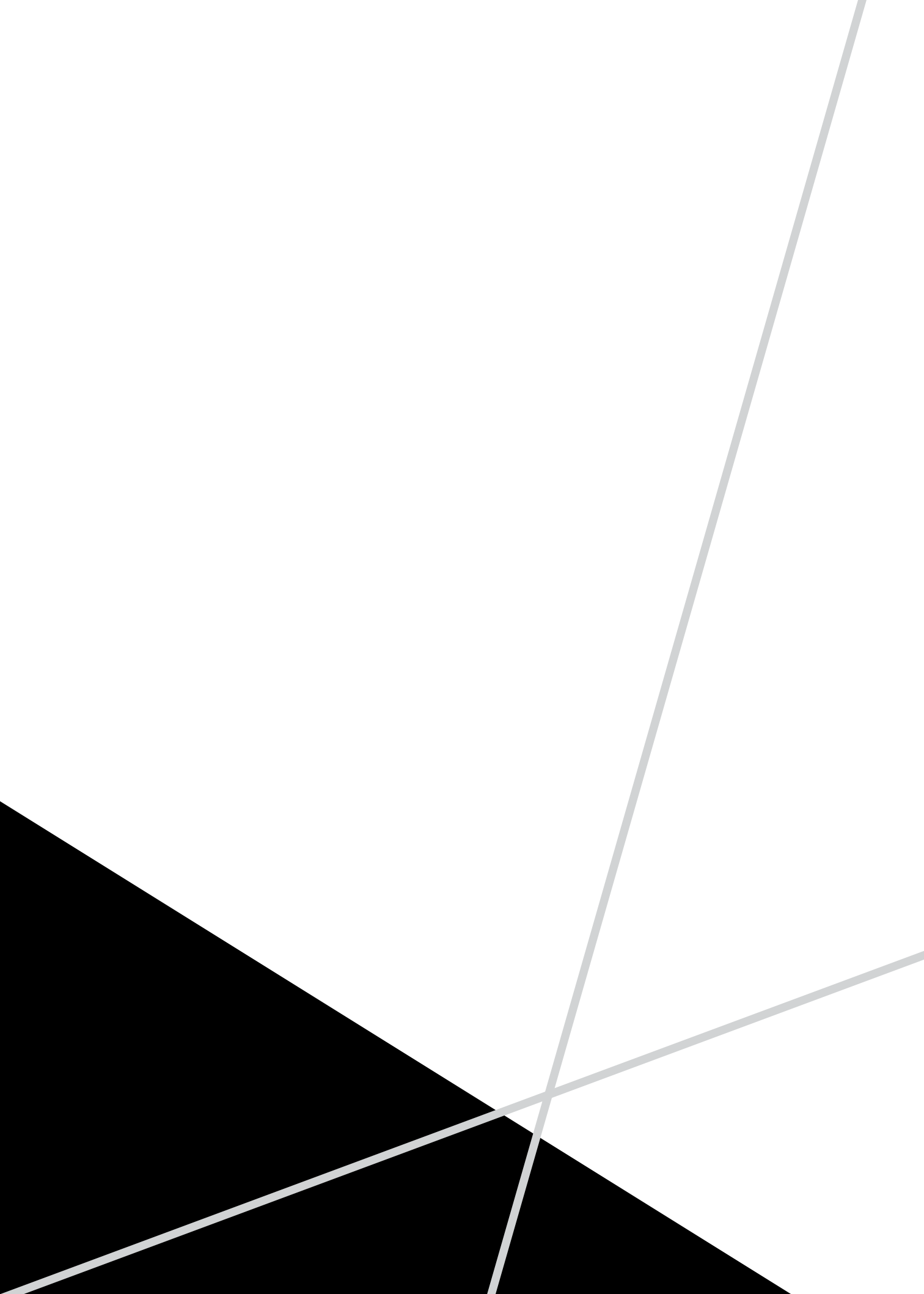



# MASTER BOOK.14



# INDICE GENERALE

MASTER INDEX / GESAMTINHALT / INDEX GENERAL / ÍNDICE GENERAL

Storia	04	Essere	130
Prodotti	06	Home Teak	132
Ambiente	08	Indian Silk	142
<b>AREATECH</b>	10	Legnotech	146
Archistone	12	Neostone	150
EC1	24	Reflex Design	158
EC1 Levitas T5,6	32	Saturnia	160
Formwork	40	Tivoli	164
Hamada	52	Versilia Zebrino	170
Paver	54	Versilia Carrara	174
Pietra Piasentina	56	Yestone	178
Pietraforte	60	<b>CERDISAWHITE</b>	180
Portland	64	Glitter	182
Sandstone	72	<b>CERDISAWALL</b>	186
Stone Cult	76	Perlage	188
Tinte Unite / Graniti	78	Trend	192
<b>FACCIATE VENTILATE</b>	84	<b>TECH-INFO</b>	196
<b>POOL COLLECTION</b>	86	Simbologia	198
H <sub>2</sub> O Life Project	88	Certificazioni	198
H <sub>2</sub> O Sport Project	96	Consigli di posa	202
<b>CERDISASTONE</b>	106	Manutenzione	204
Altaj	108	Tabelle Tecniche Areatech	206
Cementi	114	Prodotti Antiscivolo	208
Chalet	118	Tabelle Tecniche Cerdisastone	210
Cityline	124	Tabelle Tecniche Cerdisawhite/wall	211

# L'eccellenza: tra tradizione e innovazione

Excellence: a blend of tradition and innovation / Qualität: Tradition und Innovation / L'excellence : entre tradition et innovation / La excelencia: entre la tradición y la innovación





**Cerdisa Ceramiche** di Sassuolo fondata nel 1959, nasce come industria produttrice di piastrelle da rivestimento in pasta bianca, per poi allargare e diversificare la sua offerta seguendo gli sviluppi della tecnologia produttiva più innovativa, attuata negli stabilimenti del **Gruppo Ceramiche Ricchetti Spa**. Cerdisa è stata una delle primissime aziende a produrre Gres Fine Porcellanato e ad entrare a pieno titolo nel mondo dei grandi progetti. Oggi il marchio Cerdisa identifica una serie di prodotti in ceramica da pavimento e rivestimento dalle forti valenze estetiche e tecnologiche, con un posizionamento nel segmento più alto del mercato per ricerca, creatività e qualità. L'innovazione è radicata in un patrimonio di esperienza e ricerca che si sono consolidate nel tempo, orientandosi sempre di più verso le esigenze dei propri clienti con l'offerta di soluzioni a servizio completo per costruire ambienti accessibili dal singolo e dalla collettività.

**Cerdisa Ceramiche** of Sassuolo founded in 1959, was established as a manufacturer of white-body wall tiles, before extending and diversifying its offering in response to the development of cutting-edge production technologies at the plants of the **Ceramiche Ricchetti Group Spa**. Cerdisa was one of the very first companies to produce fine porcelain stoneware and win recognition in the major projects sector. Today, the Cerdisa brand appears on a range of ceramic floor and wall coverings with high appearance and technology values, positioned at the high end of the market in terms of research, creativity and quality. Its innovation is rooted in a legacy of experience and research consolidated over time, with an ever-increasing focus on the needs of its customers, reflected in full-service solutions for the construction of design schemes suitable for the individual or the community.

**Cerdisa Ceramiche**, Sassuolo, wurde 1959 als Unternehmen für die Herstellung von weißscherbigen Wandfliesen gegründet. In den Folgejahren erfuhr das Produktsortiment im Zuge der technologischen Weiterentwicklung an den Standorten der **Gruppe Ceramiche Ricchetti Spa** eine Erweiterung und Diversifizierung. Cerdisa zählte zu den ersten Herstellern von Feinsteinzeug und Objektkeramik. Heute steht die Marke Cerdisa für keramische Boden- und Wandfliesen mit erstklassigen optischen und technischen Eigenschaften, die aufgrund ihrer Erlesenheit, Kreativität und Qualität im oberen Preissegment angesiedelt sind. Die Innovation wurzelt in der langjährigen Kompetenz und Erfahrung im Angebot von Komplettlösungen für private und öffentliche Bereiche, die den kundenspezifischen Anforderungen Rechnung tragen.

Fondée en 1959, **Cerdisa Ceramiche** de Sassuolo voit le jour en tant qu'industrie productrice de carreaux de revêtement en pâte blanche. Au fil des ans, elle élargit et diversifie son offre, mise en œuvre dans les établissements du **Groupe Ceramiche Ricchetti Spa** en s'appuyant sur les développements d'une technologie de production très innovante. Cerdisa a été l'une des toutes premières entreprises à produire du grès cérame fin et à s'inscrire pleinement dans le monde des grands projets. Aujourd'hui, la marque Cerdisa identifie toute une offre de produits de revêtements céramiques pour sols et murs à valeur esthétique et technologique forte, avec un positionnement sur un segment de marché haut de gamme en termes de recherche, de créativité et de qualité. L'innovation s'appuie sur l'expérience et la recherche enracinées dans un patrimoine, et qui se sont consolidées au fil du temps. Son évolution est axée sur les exigences de ses clients, avec des solutions complètes de prestations pour construire des environnements accessibles aux particuliers et à la collectivité.

**Cerdisa Ceramiche** de Sassuolo, empresa fundada en 1959, nace como industria productora de azulejos para revestimiento de pasta blanca, si bien después amplía y diversifica su oferta siguiendo el desarrollo de la tecnología de fabricación más innovadora, que se implementa y aplica en los establecimientos del **Grupo Ceramiche Ricchetti Spa**. Cerdisa fue una de las primeras empresas en dedicarse a la fabricación de Gres Fino Porcelánico y entrar de lleno en el mundo de los grandes proyectos. Actualmente la firma Cerdisa identifica una serie de productos de cerámica para pavimento y revestimiento de extraordinario valor estético y tecnológico y está posicionada en el segmento más alto del mercado gracias a su labor de investigación, su creatividad y calidad. La innovación hunde sus raíces en un bagaje de experiencia e investigación consolidado a lo largo del tiempo y se orienta cada vez más hacia la satisfacción de las exigencias de los clientes ofreciendo soluciones que prestan un servicio completo en la construcción de espacios accesibles tanto para cada persona como para la colectividad.



# Soluzioni per il progetto contemporaneo

Solutions for contemporary architecture / Moderne Objektlösungen / Des solutions pour un projet contemporain / Propuestas para proyectos contemporáneos





Tradizione ceramica ed estetica rigorosamente Made in Italy, esperienza e innovazione si traducono in un'eccellenza che indirizza la ricerca di Cerdisa verso nuove soluzioni per il mondo dell'architettura e del progetto. In linea con le tendenze del design più evoluto Cerdisa produce piastrelle ricche di fascino e funzionalità: prodotti trasversali per un utilizzo in interno ed esterno, a pavimento e rivestimento con soluzioni coordinate per l'edilizia commerciale e residenziale. Cerdisa dedica grande energia per tutelare e rafforzare la qualità e l'originalità dei suoi prodotti, attraverso un continuo e costante investimento nell'innovazione e nell'implementazione di nuovi processi produttivi. Dal prodotto, passando attraverso il servizio e gli strumenti di comunicazione che l'azienda mette a disposizione dei suoi clienti, scaturisce un'identità forte, immediata e riconoscibile, dallo stile contemporaneo ed essenziale.

Strictly all-Italian ceramic tile tradition and styling, experience and innovation, are all combined in an excellence that guides Cerdisa towards new solutions for the world of architecture and large projects. In line with cutting-edge design trends, Cerdisa produces tiles that are beautiful yet functional: versatile products, for use indoors and outdoors, on floors and walls, with coordinated solutions for the commercial and residential construction sectors. Cerdisa devotes considerable energy to safeguarding and reinforcing its products' quality and originality, through continual, constant investment in innovation and the implementation of new production processes. Aided by the service and the advertising tools the company provides to its customers, products have a strong, immediate, distinctive identity, with a contemporary, essential style.

Keramik- und Designtradition Made in Italy. Erfahrung und Innovation legen den Grundstein für einen Qualitätsanspruch, der das Augenmerk von Cerdisa auf neue Architektur- und Objektlösungen richtet. In Übereinstimmung mit den neuesten Designrends produziert Cerdisa faszinierende und funktionelle Fliesen: Vielseitige Produkte für kombinierte Boden- und Wandbekleidungen in Innen- und Außenbereichen für gewerbliche und private Bauobjekte. Cerdisa ist um die Wahrung und Steigerung der Qualität und Originalität der eigenen Produkte bemüht. Hierfür investiert das Unternehmen kontinuierlich und konstant in die Innovation und Implementierung von neuen Herstellungsverfahren. Beginnend beim Produkt über den Service bis hin zu den Kommunikationstools, die das Unternehmen für seine Kunden bereithält, entsteht eine starke, eingängige und wiedererkennbare Identität, die einen zeitgemäßen, minimalistischen Stil verkörpert.

L'excellence traduit la tradition céramique et esthétique rigoureusement « Made in Italy » de Cerdisa, dont la recherche est orientée vers de nouvelles solutions pour le monde de l'architecture et des projets. En phase avec les tendances du design le plus évolué, Cerdisa fabrique des carrelages empreints de charme et de fonctionnalité : des produits transversaux pour un usage en extérieur et en intérieur, des revêtements pour sols et murs aux solutions coordonnées pour les bâtiments commerciaux et résidentiels. Cerdisa consacre une grande énergie à la valorisation et au renforcement de la qualité et de l'originalité de ses produits, investissant continuellement dans l'innovation et la mise en œuvre de nouveaux processus de production. Une identité forte, immédiate et reconnaissable, au style contemporain et essentiel en résulte, fondée sur le produit, le service et les outils de communication que l'entreprise met à disposition de ses clients.

Tradición cerámica y estética rigurosamente "made in Italy", experiencia e innovación se traducen en una excelencia que orienta la investigación de Cerdisa hacia nuevas soluciones para el mundo de la arquitectura y los proyectos. En sintonía con las tendencias del más avanzado diseño Cerdisa fabrica azulejos llenos de encanto y funcionalidad: se trata de productos transversales válidos tanto para espacios interiores como exteriores, para pavimentar suelos y revestir paredes, con propuestas coordinadas tanto para la construcción comercial como para la residencial. Cerdisa dedica una enorme energía a salvaguardar y reforzar la calidad y originalidad de sus productos mediante una continua y constante inversión en innovación y en la implementación de nuevos procesos de fabricación. Con el producto que ofrece, el servicio que presta y las herramientas de comunicación que pone a disposición de sus clientes, la firma transmite una identidad fuerte, inmediata y perfectamente reconocible, de estilo contemporáneo y austero.

# Il rispetto per l'ambiente

Environment-friendliness / Aus Liebe zur Umwelt / Le respect de l'environnement / Respeto por el medio ambiente





Un atteggiamento etico e responsabile caratterizza l'impegno di Cerdisa nei confronti dell'ambiente e delle persone che ne fanno parte. Da molto tempo l'azienda si è attivata per migliorare i processi produttivi e la qualità dei prodotti attraverso una riduzione dei consumi e con l'utilizzo di energie rinnovabili. Impianti tecnologicamente all'avanguardia lavorano con un sistema di raccolta e di utilizzo degli scarti di produzione e delle acque di lavorazione, garantendo la massima qualità durante l'intero processo di produzione, certificato secondo le norme **UNI EN ISO 9001**. Cerdisa fa parte dell' **U.S Green Building Council (USGBC)**, l'associazione americana che si occupa di implementare e regolamentare la costruzione di edifici sostenibili attraverso la certificazione **LEED®** (Leadership in Energy and Environmental Design).

Cerdisa takes an ethical, responsible attitude to the environment and the people who belong to it. The company has been working for a long time to improve production processes and product quality by reducing consumption and using renewable energy sources. Plants at the technological state of the art work with a system for the collection and reuse of production waste and process water, guaranteeing the very highest quality throughout the entire production process, certified in accordance with the **UNI EN ISO 9001** standards. Cerdisa is a member of the **U.S. Green Building Council (USGBC)**, the American association that implements and regulates the construction of sustainable buildings by means of **LEED®** (Leadership in Energy and Environmental Design) certification. Thanks to their technical-structural characteristics and 20% to 40% recycled material content, many Cerdisa brand products are able to contribute to a building's LEED® score.

Ethik und Verantwortlichkeit kennzeichnen das Engagement von Cerdisa gegenüber der Umwelt und dem Menschen. Seit vielen Jahren optimiert das Unternehmen seine Produktionsprozesse und die Produktqualität durch verbrauchsenkende Maßnahmen und die Verwendung von erneuerbaren Energien. Hochmoderne Anlagen arbeiten mit einem System für die Sammlung und Wiederverwendung von Produktionsabfällen und Prozesswasser und garantieren damit höchste Qualitätsstandards im gesamten Produktionsprozess, die gemäß **UNI EN ISO 9001** zertifiziert sind. Cerdisa ist Mitglied des **U.S. Green Building Council (USGBC)**, des US-amerikanischen Verbands für die Implementierung und Normierung von nachhaltigem Bauen anhand der **LEED®**-Zertifizierung (Leadership in Energy and Environmental Design). Zahlreiche Produkte der Marke Cerdisa können aufgrund ihrer technisch-strukturellen Eigenschaften und ihres Recyclinganteils von 20 % bis 40 % zur Erreichung der notwendigen Punktezahl für Gebäude gemäß den LEED®-Parametern beitragen.

Une attitude éthique et responsable : c'est ce qui définit l'engagement de Cerdisa envers l'environnement et les personnes qui en font partie. Depuis très longtemps déjà, l'entreprise a mis en œuvre les améliorations de ses processus de production et de la qualité de ses produits en réduisant la consommation et en utilisant les énergies renouvelables. Des établissements d'avant-garde au plan technologique travaillent avec un système de recueil et de recyclage des déchets industriels et des eaux de traitement, garantissant ainsi la plus grande qualité durant tout le processus de production, certifié selon les normes **UNI EN ISO 9001**. Cerdisa fait partie du **U.S. Green Building Council (USGBC)**, l'association américaine qui s'occupe de mettre en œuvre et de réglementer la construction d'édifices durables à travers la certification **LEED®** (Leadership in Energy and Environmental Design). Du fait de leurs caractéristiques technico-structurales et d'un pourcentage variant entre 20 et 40 % du contenu en matériel recyclé, de nombreux produits de la marque Cerdisa peuvent contribuer à l'atteinte du nombre de points attribués à un bâtiment, selon les paramètres LEED®.

Una actitud ética y responsable caracteriza el compromiso de Cerdisa para con el medio ambiente y las personas que lo habitan. Desde hace mucho tiempo la empresa viene tomando medidas para mejorar sus procesos productivos y la calidad de sus productos a través de la reducción del consumo y el empleo de energías renovables. Las instalaciones, de vanguardia desde el punto de vista tecnológico, incorporan sistemas de recogida y uso de los residuos de producción y las aguas de elaboración; además garantizan la máxima calidad a lo largo de todo el proceso de fabricación, que cuenta con la certificación de conformidad con las normas **UNI EN ISO 9001**. Cerdisa forma parte del **U.S. Green Building Council (USGBC)**, el organismo estadounidense que se ocupa de implementar y reglamentar la construcción de edificios sostenibles a través de la certificación **LEED®** (Leadership in Energy and Environmental Design). Muchos de los productos que llevan el sello de Cerdisa, por sus características técnicas y estructurales y por la cantidad de material reciclado que contienen (con porcentajes que van del 20 al 40%), pueden contribuir a lograr la puntuación que, de acuerdo con los parámetros LEED®, se le exige a un edificio para conseguir dicha certificación.



The image features a minimalist, abstract design. It consists of several geometric shapes: a large black triangle on the left side, a white triangle on the right side, and two intersecting lines. One line is a light gray color and slopes upwards from left to right. The other line is a slightly darker gray and slopes downwards from left to right. The intersection of these lines and the triangles creates a complex, layered visual effect.

AREATECH

# ARCHISTONE

Gres fine porcellanato Bla UGL EN 14411 / Fine porcelain stoneware / Feinsteinzeug / Grès cérame fin / Gres fino porcelánico





Lightstone Grip 60x60  
Mosaico 3D Lightstone Rett. 30x60



Pizzo Grafite 30x60  
Trama Grafite 30x60  
Grafite Lapp. 60x60

**Formati / Sizes / Grösse / Format / Tamaño:**



60x120 Rett.  
24"x48"



30x120 Rett.  
12"x48"



60x60 Rett.  
24"x24"



30x60 Rett.  
12"x24"



30x30 Rett.  
12"x12"

**Superfici / Surface / Oberfläche / Surface / Superficie**

**NATURALE** / NATURAL / NATUR / NATURELLE / NATURAL

**LAPPATO** / HONED / LEICHT POLIERT / POLI ADOUCI / PULIDO

**GRIP** / GRIP SURFACE / SURFACE GRIP / GRIFFIGE OBERFLÄCHE / SUPERFICIE ANTIDESLIZANTE



# ARCHISTONE

Gres fine porcellanato Bla UGL EN 14411 / Fine porcelain stoneware / Feinsteinzeug / Grès cérame fin / Gres fino porcelánico



Pietra di Bavaria Grip 60x60 / 30x60 / 30x30  
Mosaico 3D Pietra di Bavaria Rett. 30x60



Darkstone Lapp. Rett. 60x60

60x120 / 30x120 / 60x60 / 30x60 / 30x30 - 24"x48" / 12"x48" / 24"x24" / 12"x24" / 12"x12"



Limestone Crema Grip 60x120

# ARCHISTONE

Gres fine porcellanato Bla UGL EN 14411 / Fine porcelain stoneware / Feinsteinzeug / Grès cérame fin / Gres fino porcelánico



Pietra di Bavaria Nat. Rett. 60x120 / 30x120



Lightstone Nat. Rett. 60x60  
Mosaico 3D Lightstone Rett. 30x60



Grafite Crip 60x60  
Mosaico 3D Grafite Rett. 30x60



Limestone Bianco Lap. Rett. 60x60  
Mosaico 3D Limestone Bianco Rett. 30x60

# ARCHISTONE

Gres fine porcellanato Bla UGL EN 14411 / Fine porcelain stoneware / Feinsteinzeug / Grès cérame fin / Gres fino porcelánico



10.5  
60x60  
30x60  
30x30

11  
60x120  
30x120

20  
Grip

R9  
Naturali

R10  
A+B  
Grip  
Darkstone  
Limestone  
Pietra di Bavaria

R11  
A+B+C  
Grip  
Grife  
Limestone

R11  
A+B+C  
Grip 20 mm

V2  
Grife  
Limestone  
Limestone

V3  
Darkstone

V4  
Pietra  
di Bavaria

**Grafite**

**Limestone Bianco**

**Limestone Crema**



**NATURALE**  
NATURAL / NATUR / NATURELLE / NATURAL

**LAPPATO**  
HONED / LEICHT POLIERT / POLI ADOLCI / PULIDO

**GRIP**  
GRIP / GRIP / GRIFFIGE OBERFLÄCHE / ANTIDESLIZANTE



Classement

U P E C Gel

60x120 Nat./Grip/Lapp.	U4	P3	E3	C2	S
30x120 Nat./Grip/Lapp.	U4	P3	E3	C2	S
60x60 - 30x30 Nat./Grip/Lapp.	U4	P4+	E3	C2	S
30x60 Nat./Grip/Lapp.	U4	P4	E3	C2	S



Grip R10 A+B > 0.60 dry / > 0.60 wet  
Grip R11 A+B+C > 0.60 dry / > 0.60 wet



Grip R10 A+B > 36 dry / < 25 wet  
Grip R11 A+B+C > 36 dry / > 36 wet

ANSI A 137.1:2012  
Nat. R9  
Grip R10 A+B  
Grip R11 A+B+C  
DCOF ≥ 0.42



**Darkstone**

**Lightstone**

**Pietra di Bavaria**

**MATURALE**  
NATURAL / NATUR / NATURELLE / NATURAL

**LAPPATO**  
HONED / LEICHT POLIERT / POLI ADOLCI / PULIDO

**GRIP**  
GRIP / GRIP / GRIFFIGE OBERFLÄCHE / ANTIDESLIZANTE



# ARCHISTONE *wallproject*

Gres fine porcellanato Bla UGL EN 14411 / Fine porcelain stoneware / Feinsteinzeug / Grès cérame fin / Gres fino porcelánico



**10.5**  
60x60  
30x60  
30x30

**11**  
60x120  
30x120

**20**  
Grip

**R9**  
Naturali

**R10**  
A+B  
Darkstone  
Lightstone  
Limestone  
Pietra di Bavaria

**R11**  
A+B+C  
Grip  
Grafite  
Limestone

**R11**  
A+B+C  
Grip 20 mm



**V2**  
Grafite  
Lightstone  
Limestone

**V3**  
Darkstone

**V4**  
Pietra  
di Bavaria

## DECORO PIZZO 30x60 /12"x24" 4 pcs x box

## DECORO TRAMA 30x60 /12"x24" 4 pcs x box

Grafite Rett.  
**0050785**



Grafite Rett.  
**0050786**

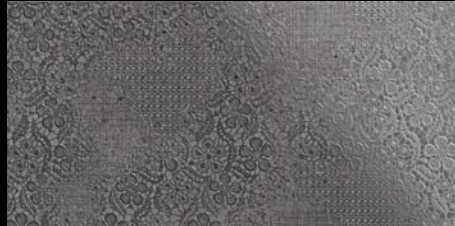

Limestone Bianco Rett.  
**0050725**



Limestone Bianco Rett.  
**0050726**



Limestone Crema Rett.  
**0050755**



Limestone Crema Rett.  
**0050756**



Darkstone Rett.  
**0050885**



Darkstone Rett.  
**0050886**



Lightstone Rett.  
**0050855**



Lightstone Rett.  
**0050856**

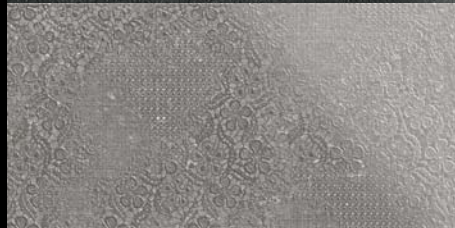

## DECORO DAMASCATO



Grafite Rett.  
**0050784**

Limestone Bianco Rett.  
**0050724**

Limestone Crema Rett.  
**0050754**

Darkstone Rett.  
**0050884**



Classement

U P E C Gel

60x120 Nat./Grip/Lapp.	U4	P3	E3	C2	S
30x120 Nat./Grip/Lapp.	U4	P3	E3	C2	S
60x60 - 30x30 Nat./Grip/Lapp.	U4	P4+	E3	C2	S
30x60 Nat./Grip/Lapp.	U4	P4	E3	C2	S



Grip R10 A+B > 0.60 dry / > 0.60 wet  
Grip R11 A+B+C > 0.60 dry / > 0.60 wet



Grip R10 A+B > 36 dry / < 25 wet  
Grip R11 A+B+C > 36 dry / > 36 wet

ANSI A 137.1:2012  
Nat. R9  
Grip R10 A+B  
Grip R11 A+B+C  
DCOF ≥ 0.42



**MOSAICO 30x30** /12"x12" 4 pcs x box

Grafite Rett.  
**0050781**

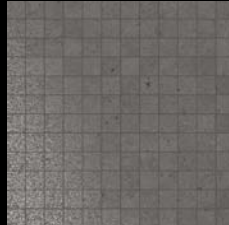
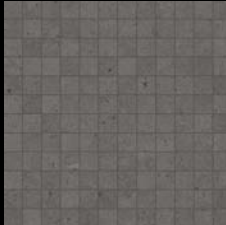

Limestone Bianco Rett.  
**0050721**



Limestone Crema Rett.  
**0050751**

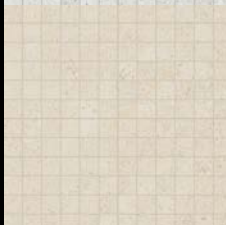

Darkstone Rett.  
**0050881**



Lightstone Rett.  
**0050851**

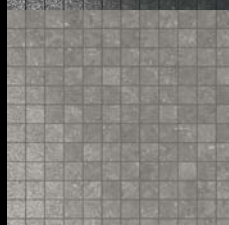
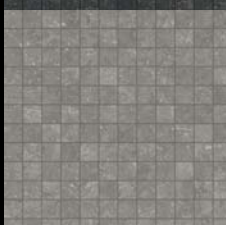

Pietra di Bavaria Rett.  
**0050821**



Grafite Lapp.  
**0050782**

Limestone Bianco Lapp.  
**0050722**

Limestone Crema Lapp.  
**0050752**

Darkstone Lapp.  
**0050882**

Lightstone Lapp.  
**0050852**

Pietra di Bavaria Lapp.  
**0050822**

**MOSAICO 3D 30x60** /12"x24" 4 pcs x box



**0050783** - Grafite Rett.



**0050723** - Limestone Bianco Rett.



**0050753** - Limestone Crema Rett.



**0050883** - Darkstone Rett.



**0050853** - Lightstone Rett.

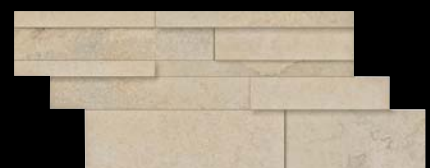

**0050823** - Pietra di Bavaria Rett.



# ARCHISTONE

Gres fine porcellanato Bla UGL EN 14411 / Fine porcelain stoneware / Feinsteinzeug / Grès cérame fin / Gres fino porcelánico



	Classement				
	U	P	E	C	Gel
60x120 Nat./Grip/Lapp.	U4	P3	E3	C2	S
30x120 Nat./Grip/Lapp.	U4	P3	E3	C2	S
60x60 - 30x30 Nat./Grip/Lapp.	U4	P4+	E3	C2	S
30x60 Nat./Grip/Lapp.	U4	P4	E3	C2	S

PENDULUM TEST BS 7976 Grip R10 A+B > 36 dry / < 25 wet  
Grip R11 A+B+C > 36 dry / > 36 wet

ANSI A 137.1-2012 Nat. R9 Grip R10 A+B Grip R11 A+B+C DCF ≥ 0,42

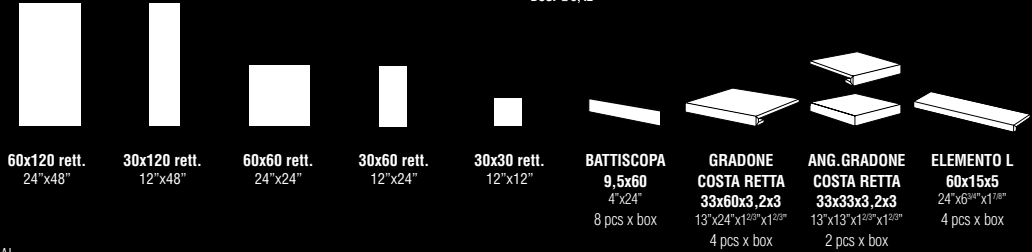

## NATURALE

NATURAL / NATUR / NATURELLE / NATURAL

Grafito	0050788	0051020	0050771	0050773	-	0050777	0050779	0050780	-
Limestone Bianco	0050728	0051000	0050711	0050713	-	0050717	0050719	0050720	-
Limestone Crema	0050758	0051010	0050741	0050743	-	0050747	0050749	0050750	-
Darkstone	0050888	0051050	0050871	0050873	0050875	0050877	0050879	0050880	-
Lightstone	0050858	0051040	0050841	0050843	0050845	0050847	0050849	0050850	-
Pietra di Bavaria	0050828	0051030	0050811	0050813	0050815	0050817	0050819	0050820	-

## LAPPATO

HONED / LEICHT POLIERT / POLI ADOUCI / PULIDO

Grafito	0050789	0051021	0050772	0050774	-	0050778	-	-	-
Limestone Bianco	0050729	0051001	0050712	0050714	-	0050718	-	-	-
Limestone Crema	0050759	0051011	0050742	0050744	-	0050748	-	-	-
Darkstone	0050889	0051051	0050872	0050874	0050876	0050878	-	-	-
Lightstone	0050859	0051041	0050842	0050844	0050846	0050848	-	-	-
Pietra di Bavaria	0050829	0051031	0050812	0050814	0050816	0050818	-	-	-

## GRIP

GRIP SURFACE / SURFACE GRIP / GRIFFIGE OBERFLÄCHE / SUPERFICIE ANTIDESLIZANTE

Grafito	0050797	0051022	0050791	0050792	-	-	-	-	0050795
Limestone Bianco	0050737	0051002	0050731	0050732	-	-	-	-	0050735
Limestone Crema	0050767	0051012	0050761	0050762	-	-	-	-	0050765
Darkstone	0050897	0051052	0050891	0050892	0050893	-	-	-	0050895
Lightstone	0050867	0051042	0050861	0050862	0050863	-	-	-	0050865
Pietra di Bavaria	0050837	0051032	0050831	0050832	0050833	-	-	-	0050835

## GRIP 20mm - R11 A+B+C

GRIP SURFACE / SURFACE GRIP / GRIFFIGE OBERFLÄCHE / SUPERFICIE ANTIDESLIZANTE

Grafito R11 A+B+C	-	-	0050799	-	-	-	-	-	-
Limestone Bianco R11 A+B+C	-	-	0050739	-	-	-	-	-	-
Limestone Crema R11 A+B+C	-	-	0050769	-	-	-	-	-	-
Darkstone R11 A+B+C	-	-	0050899	-	-	-	-	-	-
Lightstone R11 A+B+C	-	-	0050869	-	-	-	-	-	-
Pietra di Bavaria R11 A+B+C	-	-	0050839	-	-	-	-	-	-

## GRADONE COSTA RETTA

33 cm



Imballi / Packing / Verpackungen / Emballages / Embalajes

Formato	Pezzi/Sc.	Mq/Sc	Sc/Pal	Mq/Pal	Kg/Sc	Kg/Pal
Size	Pcs/Box	Sq.M/Box	Box/Pal	Sq.M/Pal	Kg/Box	Kg/Pal
Größe	Pcs/Ctn	Mq/Ctn	Ctn/Pal	Mq/Pal	Kg/Ctn	Kg/Pal
Format	Stck/Kart	Qm/Kart	Kart/Pal	Qm/Pal	Kg/Kart	Kg/Pal
Tamaño	Piezas/Caja	Mq/Caja	Caja/Pal	Mq/Pal	Kg/Caja	Kg/Pal
60x120	2	1,44	18	25,92	36,00	648,0
30x120	2	0,72	36	25,92	18,00	648,0
60x60	4	1,44	24	34,56	34,20	820,8
60x60 sp. 20 mm	2	0,72	32	23,04	32,50	1040,0
30x60	6	1,08	32	34,56	25,60	819,2
30x30	11	0,99	40	39,60	22,50	900,0

## ELEMENTO A L

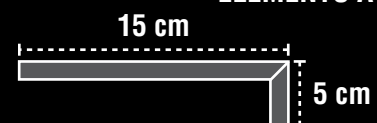

# ARCHISTONE T20 / tech-info

PENDULUM TEST BS 7976

Grip R11 A+B+C > 36 dry / > 36 wet

**RESISTENZA ALLA FLESSIONE**  
FLEXION RESISTANCE



EN ISO 10545-4  
S = 15,024 N  
R = 52,1 N/mm<sup>2</sup>

**RESISTENZA ALL'URTO**  
IMPACT RESISTANCE



EN ISO 10545-5

**CARICO STATICO**  
STATIC LOAD



EN ISO 12825  
CENTRO - CENTRE = 7,75 kN  
CENTRO LATO - CENTRE POINT OF SIDE = 5,72 kN  
DIAGONALE - DIAGONAL = 7,24 kN

**Posa sopraelevata su supporti regolabili**  
Installation using adjustable paving support

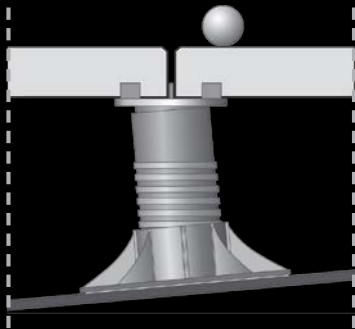

**SE**

**Supporto regolabile con testa autolivellante**

Adjustable paving support with self-levelling head



**NM**

**Supporto regolabile**

Adjustable paving support



**EH**

**Supporto**

Support



SUPPORTI REALIZZATI IN METATERIALE TOTALMENTE RICICLABILE  
SUPPORTS MADE FROM 100% RECYCLABLE MATERIAL



RESISTENTI ALLE SOLUZIONI ACIDE E BASICHE  
RESISTANT TO ACID AND ALKALI SOLUTIONS



RESISTENTI AGLI AGENTI ATMOSFERICI  
RESISTANT TO ATMOSPHERIC AGENTS



RESISTENTI A TEMPERATURE DA -30° A +120°  
RESISTANT TO TEMPERATURES FROM -30° TO +120°

**2,78 PCS** QUANTITÀ M<sup>2</sup>  
PIECES PER M<sup>2</sup>

**Posa diretta su erba**  
Installation onto grass

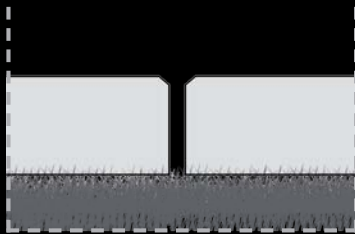

**Posa diretta su erba**  
Installation onto grass



**Posa diretta su ghiaia**  
Installation onto gravel

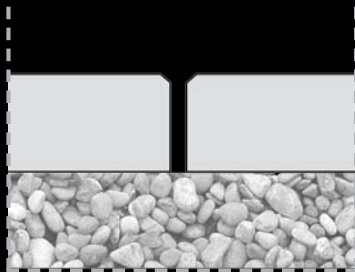

**Posa diretta su ghiaia**  
Installation onto gravel



**Posa diretta su cemento**  
Installation onto cement

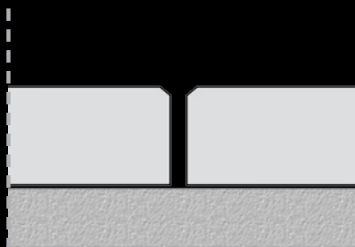

**Posa diretta su cemento**  
Installation onto cement



Tipo di supporto	Codice	Altezza supporto
SE1	A004000	da 37,5 a 50 mm
SE2	A004001	da 50 a 75 mm
SE3	A004002	da 75 a 120 mm
SE4	A004003	da 120 a 170 mm
SE5	A004004	da 170 a 215 mm
SE6	A004005	da 140 a 230 mm
SE7	A004006	da 185 a 275 mm
SE8	A004007	da 235 a 325 mm
SE9	A004008	da 205 a 345 mm
SE10	A004009	da 250 a 385 mm
SE11	A004010	da 300 a 400 mm
SE12	A004011	da 270 a 455 mm
SE13	A004012	da 315 a 500 mm
SE14	A004013	da 365 a 550 mm
NM1	A004014	da 25 a 40 mm
NM2	A004015	da 40 a 70 mm
NM3	A004016	da 60 a 100 mm
NM4	A004017	da 90 a 160 mm
NM5	A004018	da 150 a 270 mm
EH12/8	A004019	h 12 mm / ali h 8 mm
EH12	A004020	h 12 mm
EH15	A004021	h 15 mm
EH20	A004022	h 20 mm

**Equilibratore basculante**  
A004023



**Spessore livellatore**  
A004024



# EC1

Gres fine porcellanato **Bla UGL EN 14411** / Fine porcelain stoneware / Feinsteinzeug / Grès cérame fin / Gres fino porcelánico



Bank SA Strutt. Rett. 60x120  
Barbican NE Rett. Lapp. 60x120



Bank SA Rett. Lapp. 60x120  
Docks FA Rett. Lapp. 60x120  
Bank SA Rett. 60x120



Farringdon BI Elemento L Strutt. 15x60x5  
Farringdon BI Strutt. Rett. 60x120



Farringdon BI Rett. 60x120  
Docks FA Rett. 10x60  
Farringdon BI Strutt. Rett. 60x120



Docks FA Strutt. Rett. 60x60  
Docks FA Rett. 60x60

**Formati / Sizes / Grösse / Format / Tamaño:**



60x120 Rett.  
24"x48"



60x60 Rett.  
24"x24"



30x60 Rett.  
12"x24"



10x60 Rett.  
4"x24"

**Superfici / Surface / Oberfläche / Surface / Superficie**



**NATURALE / NATURAL / NATUR / NATURELLE / NATURAL**



**STRUTTURATO / TEXTURED / STRUKTURIERTE / STRUCTURÉE / ESTRUCTURADO**



**LAPPATO / HONED / LEICHT POLIERT / POLI ADOUCI / PULIDO**



**LEVIGATO / POLISHED / POLIERT / POLI / PULIMENTADO**

# EC1

Gres fine porcellanato **Bla UGL EN 14411** / Fine porcelain stoneware / Feinsteinzeug / Grès cérame fin / Gres fino porcelánico



Farringdon BI Strutt. Rett. 60x120  
Farringdon BI Rett. Lev. 60x120  
Barbican NE Rett. Lapp. 60x120 / 10x60



Barbican NE Strutt. Rett. 60x60  
Barbican NE Rett. Lev. 60x120  
Barbican NE Fascia Muretto Rett. 15x60

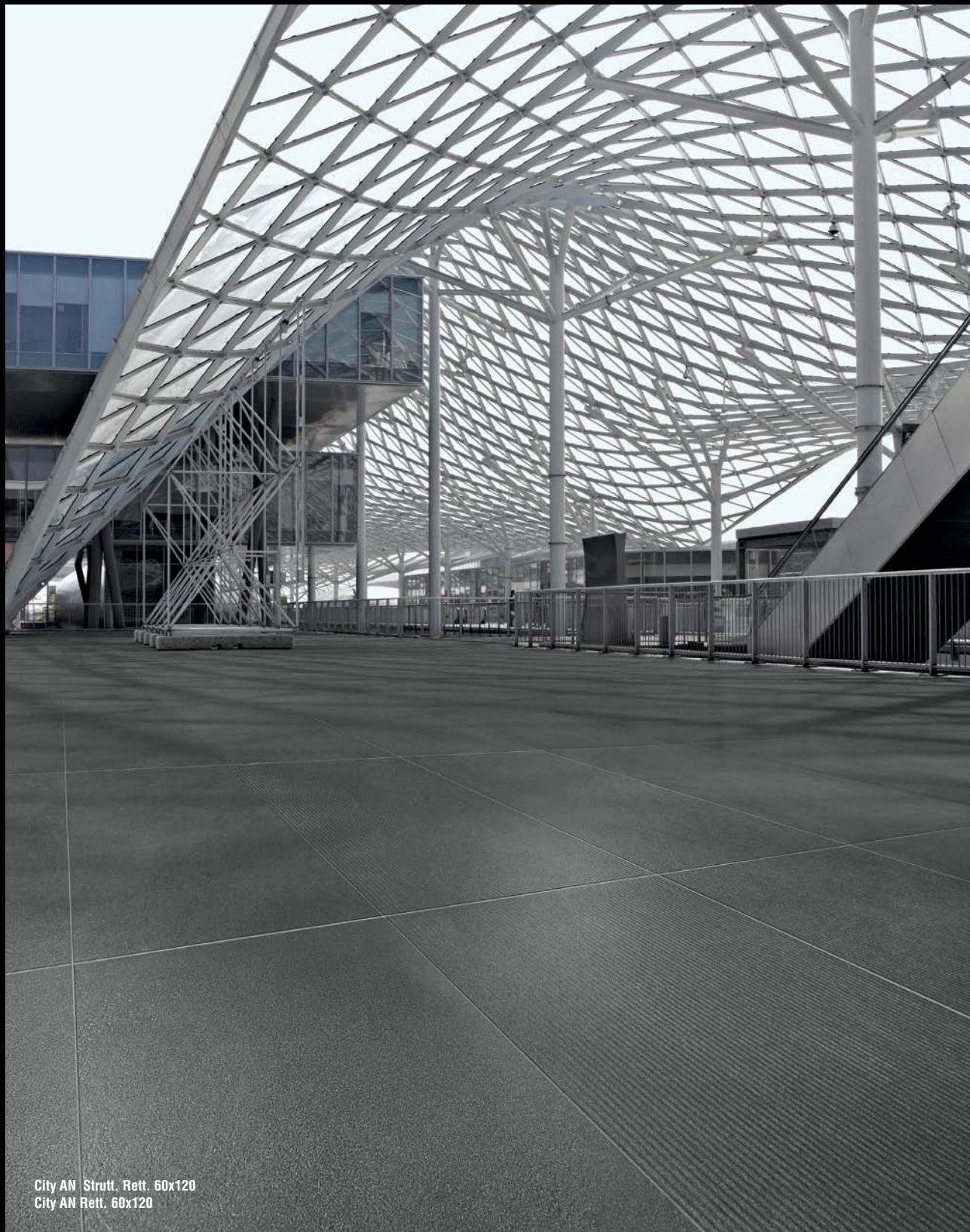

City AN Strutt. Rett. 60x120  
City AN Rett. 60x120

# EC1

Gres fine porcellanato Bla UGL EN 14411 / Fine porcelain stoneware / Feinsteinzeug / Grès cérame fin / Gres fino porcelánico



Naturale > 0.60 dry / > 0.60 wet  
Strutturato > 0.60 dry / > 0.60 wet

PENDULUM Naturale > 36 dry / da 25 a 35 wet  
TEST! Strutturato > 36 dry / da 25 a 35 wet  
BS 7976

Farringdon BI

City AN

Barbican NE

**NATURALE**  
NATURAL / NATUR / NATURELLE / NATURAL

**STRUTTURATO**  
TEXTURED / STRUKTURIERTE / STRUCTURÉE / ESTRUCTURADO

**LAPPATO**  
HONED / LEICHT POLIERT / POLI ADOLCI / PULIDO

**LEVIGATO**  
POLISHED / POLIERT / POLI / PULIMENTADO

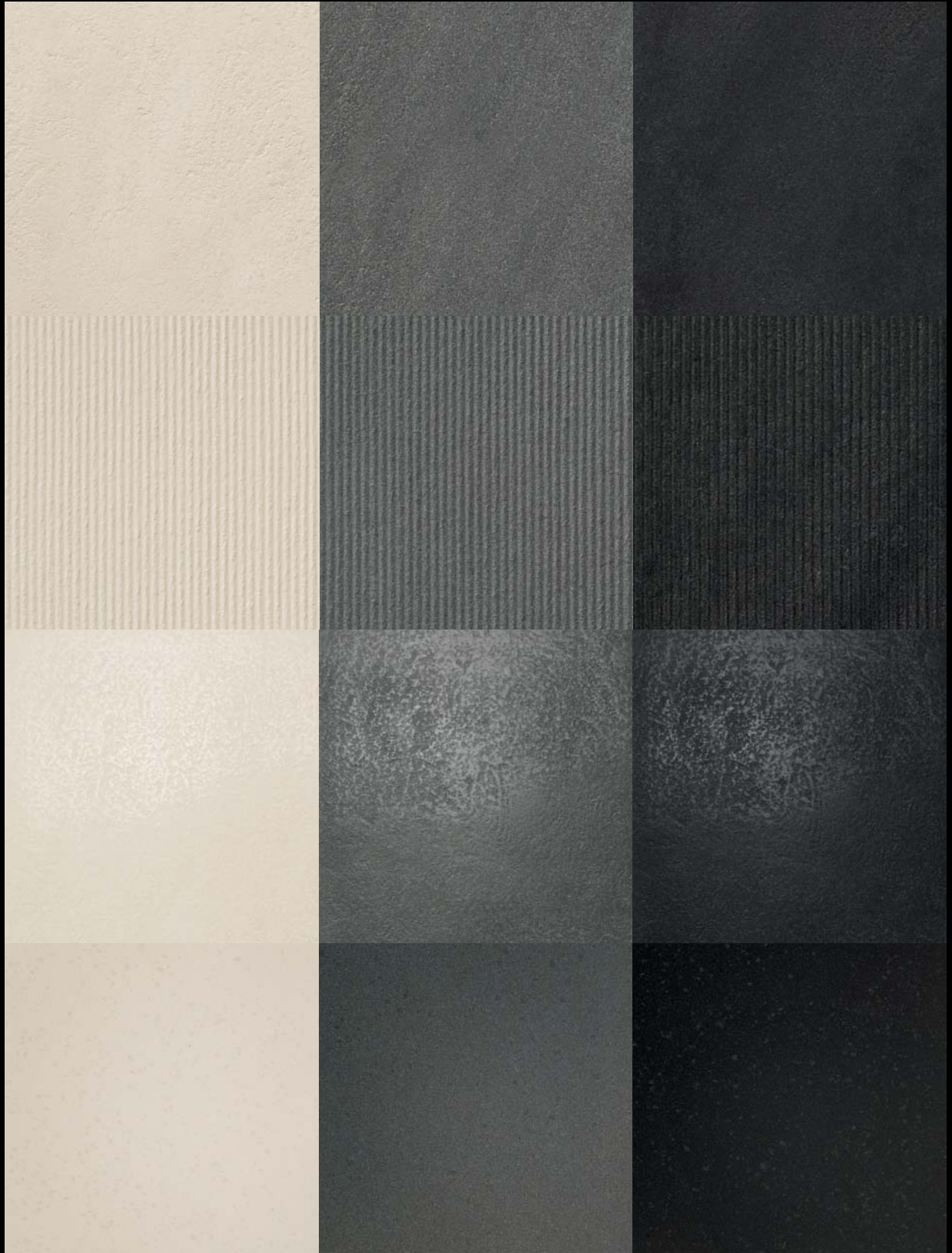



	Classement				
	U	P	E	C	GeI
60x120 Nat./Strutt./Lapp.	U4	P3	E3	C2	S
60x60 Nat./Strutt./Lapp.	U4	P4+	E3	C2	S
30x60 Nat./Strutt./Lapp.	U4	P4+	E3	C2	S
60x120 - 30x60 - 60x60 Lev.	U3	P3	E3	C2	S

**Bank SA**

**Holborn TA**

**Docks FA**

**NATURALE**  
NATURAL / NATUR / NATURELLE / NATURAL

**STRUTTURATO**  
TEXTURED / STRUKTURIERTE / STRUCTURÉE / ESTRUCTURADO

**LAPPATO**  
HONED / LEICHT POLIERT / POLIADOUCI / PULIDO

**LEVIGATO**  
POLISHED / POLIERT / POLI / PULIMENTADO





# EC1

Gres fine porcellanato Bla UGL EN 14411 / Fine porcelain stoneware / Feinsteinzeug / Grès cérame fin / Gres fino porcelánico

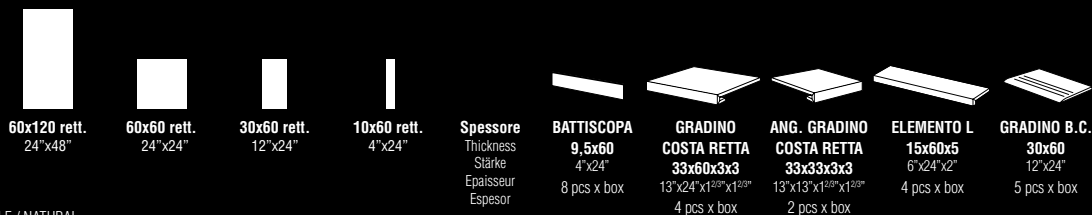

**R10**  
A

## NATURALE

NATURAL / NATUR / NATURELLE / NATURAL

Farringdon BI	0045001	0045004	0045007	0045014	11	0045012	0045030	0045031	0045032	0045035
City AN	0045161	0045164	0045167	0045174	11	0045172	0045190	0045191	0045192	0045195
Barbican NE	0045201	0045204	0045207	0045214	11	0045212	0045230	0045231	0045232	0045235
Bank SA	0045041	0045044	0045047	0045054	11	0045052	0045070	0045071	0045072	0045075
Holborn TA	0045081	0045084	0045087	0045094	11	0045092	0045110	0045111	0045112	0045115
Docks FA	0045121	0045124	0045127	0045134	11	0045132	0045150	0045151	0045152	0045155

**R12**  
A+B+C

## STRUTTURATO

TEXTURED / STRUKTURIERTE / STRUCTURÉE / ESTRUCTURADO

Farringdon BI	0045021	0045022	0045023	0045026	11	0045024	-	-	0045033	0045027
City AN	0045181	0045182	0045183	0045186	11	0045184	-	-	0045193	0045187
Barbican NE	0045221	0045222	0045223	0045226	11	0045224	-	-	0045233	0045227
Bank SA	0045061	0045062	0045063	0045066	11	0045064	-	-	0045073	0045067
Holborn TA	0045101	0045102	0045103	0045106	11	0045104	-	-	0045113	0045107
Docks FA	0045141	0045142	0045143	0045146	11	0045144	-	-	0045153	0045147

## LAPPATO

HONED / LEICHT POLIERT / POLI ADOUCI / PULIDO

Farringdon BI	0045002	0045005	0045008	0045015	11	0045016	-	-	-	0045036
City AN	0045162	0045165	0045168	0045175	11	0045176	-	-	-	0045196
Barbican NE	0045202	0045205	0045208	0045215	11	0045216	-	-	-	0045236
Bank SA	0045042	0045045	0045048	0045055	11	0045056	-	-	-	0045076
Holborn TA	0045082	0045085	0045088	0045095	11	0045096	-	-	-	0045116
Docks FA	0045122	0045125	0045128	0045135	11	0045136	-	-	-	0045156

## LEVIGATO

POLISHED / POLIERT / POLI / PULIMENTADO

Farringdon BI	0045003	0045006	-	-	10	0045034	-	-	-	0045037
City AN	0045163	0045166	-	-	10	0045194	-	-	-	0045197
Barbican NE	0045203	0045206	-	-	10	0045234	-	-	-	0045237
Bank SA	0045043	0045046	-	-	10	0045074	-	-	-	0045077
Holborn TA	0045083	0045086	-	-	10	0045114	-	-	-	0045117
Docks FA	0045123	0045126	-	-	10	0045154	-	-	-	0045157

## GRADONE COSTA RETTA

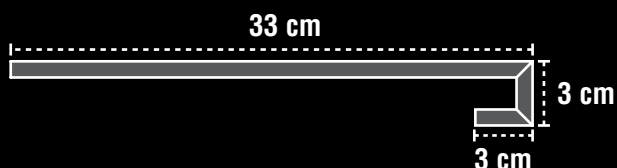

## ELEMENTO A L





Classement

	U	P	E	C	GeI
60x120 Nat./Strutt./Lapp.	U4	P3	E3	C2	S
60x60 Nat./Strutt./Lapp.	U4	P4+	E3	C2	S
30x60 Nat./Strutt./Lapp.	U4	P4+	E3	C2	S
60x120 - 30x60 - 60x60 Lev.	U3	P3	E3	C2	S

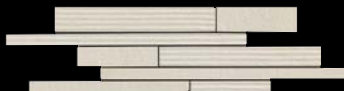

**0045013** Farrington BI Rett. 15x60 - 6"x24"  
6 pcs x box



**0045173** City AN Rett. 15x60 - 6"x24"  
6 pcs x box

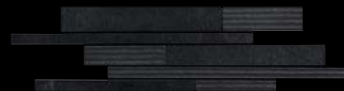

**0045213** Barbican NE Rett. 15x60 - 6"x24"  
6 pcs x box

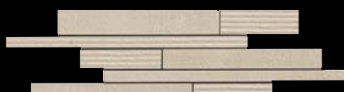

**0045053** Bank SA Rett. 15x60 - 6"x24"  
6 pcs x box

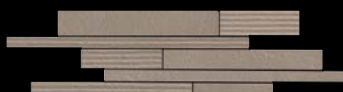

**0045093** Holborn TA Rett. 15x60 - 6"x24"  
6 pcs x box



**0045133** Docks FA Rett. 15x60 - 6"x24"  
6 pcs x box

Imballi / Packing / Verpackungen / Embalajes / Embalajes

Formato	Pezzi/Sc.	Mq/Sc	Sc/Pal	Mq/Pal	Kg/Sc	Kg/Pal
Size	Pcs/Box	Sq./M/Box	Box/Pal	Sq./M/Pal	Kg/Box	Kg/Pal
Grösse	Pcs/Ctn	Mq/Ctn	Ctn/Pal	Mq/Pal	Kg/Ctn	Kg/Pal
Format	Stck/Kart	Qm/Kart	Kart/Pal	Qm/Pal	Kg/Kart	Kg/Pal
Tamaño	Piezas/Caja	Mq/Caja	Caja/Pal	Mq/Pal	Kg/Caja	Kg/Pal
<b>60x120</b>	<b>2</b>	<b>1,44</b>	<b>18</b>	<b>25,92</b>	<b>36</b>	<b>648</b>
<b>60x60</b>	<b>4</b>	<b>1,44</b>	<b>24</b>	<b>34,56</b>	<b>36</b>	<b>864</b>
<b>30x60</b>	<b>6</b>	<b>1,08</b>	<b>32</b>	<b>34,56</b>	<b>27</b>	<b>864</b>
<b>10x60</b>	<b>16</b>	<b>0,96</b>	<b>48</b>	<b>46,08</b>	<b>24</b>	<b>1152</b>

Holborn TA Strutt. Rett. 60x120  
Holborn TA Fascia Muretto Rett. 15x60  
Barbican NE Rett. 60x120  
Barbican NE Rett. Lev. 60x60



# EC1 LEVITAS T5,6

Gres fine porcellanato Bia UGL EN 14411 / Fine porcelain stoneware / Feinsteinzeug / Grès cérame fin / Gres fino porcelánico

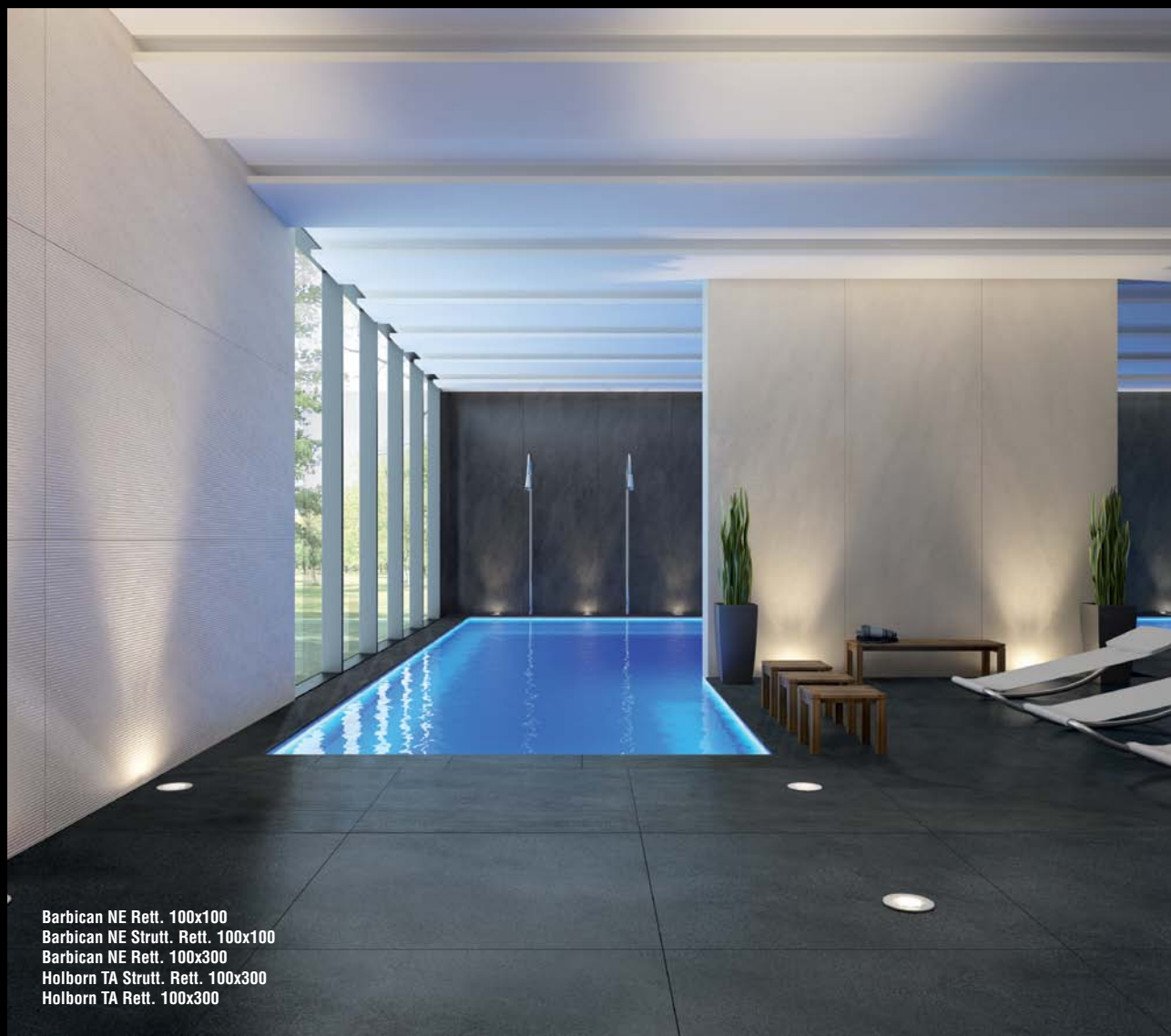

**100x300**

**50x150**

**100x100**



**Formati** / Sizes / Grösse / Format / Tamaño:

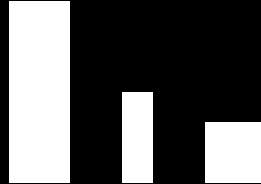

100x300 Rett. 50x150 Rett. 100x100 Rett.  
40"x120" 20"x60" 40"x40"

**Superfici** / Surface / Oberfläche / Surface / Superficie

**NATURALE** / NATURAL / NATUR / NATURELLE / NATURAL

**STRUTTURATO** / TEXTURED / STRUKTURIERTE / STRUCTURÉE / ESTRUCTURADO

**LAPPATO** / HONED / LEICHT POLIERT / POLI ADOUCI / PULIDO

# EC1 LEVITAS T5,6

Gres fine porcellanato Bla UGL EN 14411 / Fine porcelain stoneware / Feinsteinzeug / Grès cérame fin / Gres fino porcelánico



Docks FA Lapp. Rett. 100x100  
Docks FA Rett. 50x150  
Bank SA Strutt. Rett. 100x300



Farringdon BI Lapp. Rett. 100x100  
Holborn TA Rett. 100x300

100x300 / 50x150 / 100x100 - 40"x120" / 20"x60" / 40"x40"



Bank SA Rett. 100x300  
City AN Rett. 100x300



Holborn TA Rett. 100x300  
Holborn TA Strutt Rett. 100x100  
Docks FA Strutt. Rett. 50x150  
Farringdon BI Rett. 50x150

# EC1 LEVITAS T5,6

Gres fine porcellanato Bla UGL EN 14411 / Fine porcelain stoneware / Feinsteinzeug / Grès cérame fin / Gres fino porcelánico



Farringdon BI

City AN

Barbican NE

**NATURALE**  
NATURAL / NATUR / NATURELLE / NATURAL

**STRUTTURATO**  
TEXTURED / STRUKTURIERTE / STRUCTURÉE / ESTRUCTURADO

**LAPPATO**  
HONED / LEICHTPOLIERT / POLI ADOUCI / PULIDO

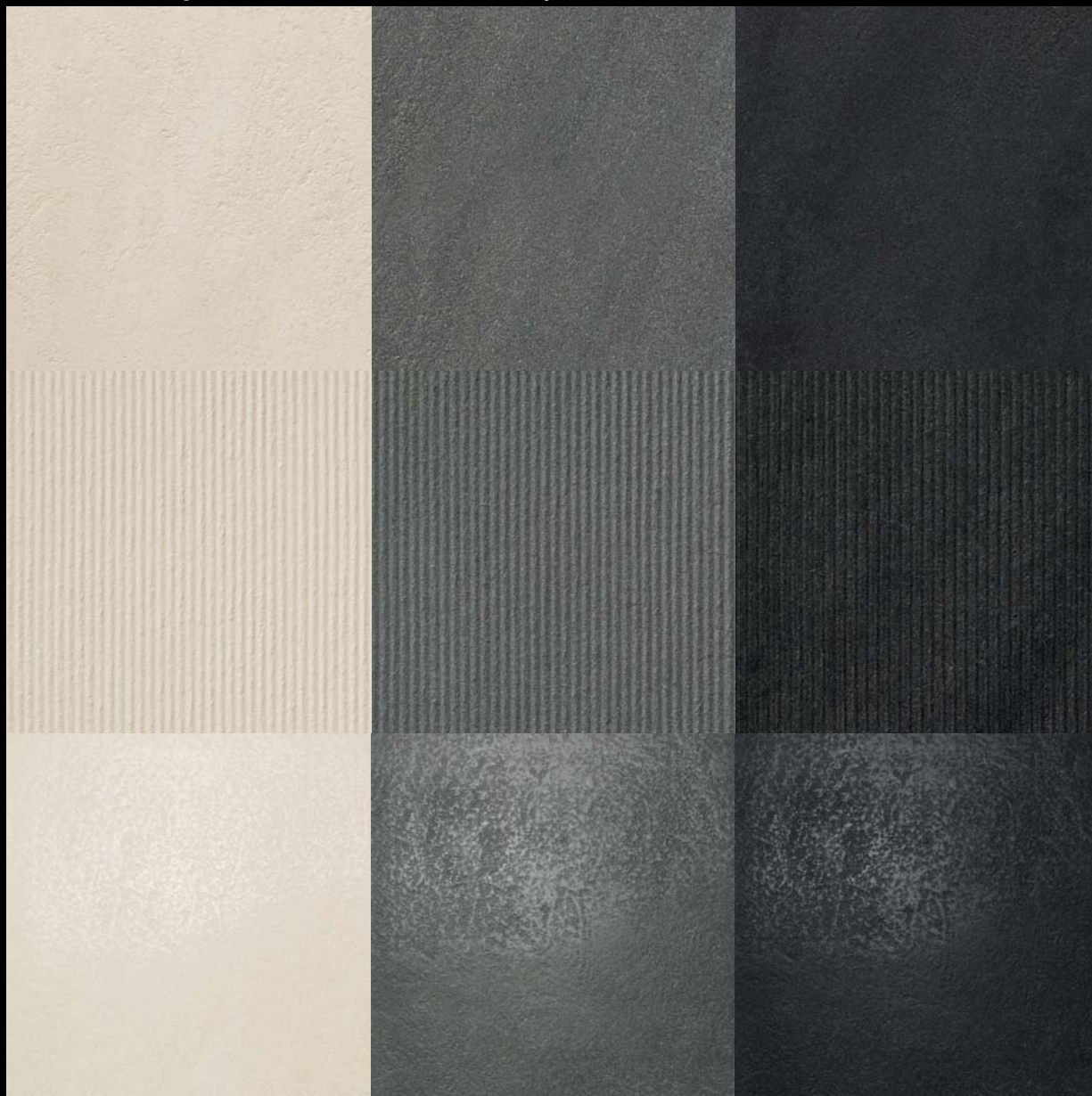

Per le modalità di utilizzo, movimentazione, taglio, foratura e posa delle lastre Levitas T5,6 si consiglia di seguire le istruzioni riportate sul relativo Manuale d'uso Levitas T5,6

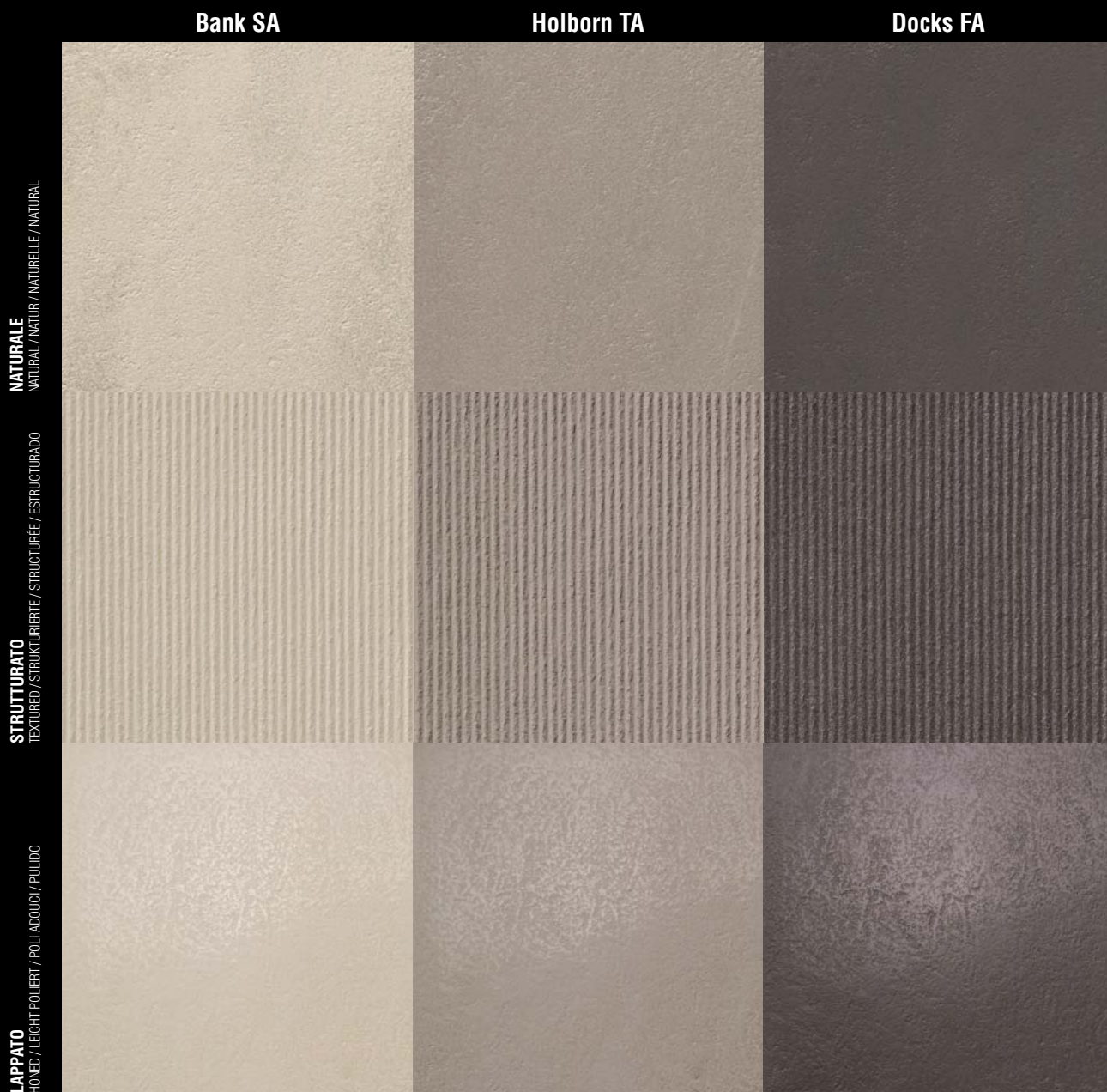

Per le modalità di utilizzo, movimentazione, taglio, foratura e posa delle lastre Levitas T5,6 si consiglia di seguire le istruzioni riportate sul relativo Manuale d'uso Levitas T5,6





Imballi / Packing / Verpackungen / Emballages / Embalajes

Formato	Pezzi/Sc.	Pezzi/Pal	Mq/Sc	Sc/Pal	Mq/Pal	Kg/Sc	Kg/Pal
Size	Pcs/Box	Pcs/Pal	Sq.M/Box	Box/Pal	Sq.M/Pal	Kg/Box	Kg/Pal
Größe	Pcs/Ctn	Pcs/Pal	Mq/Ctn	Ctn/Pal	Mq/Pal	Kg/Ctn	Kg/Pal
Format	Stck/Kart	Stck/Pal	Qm/Kart	Kart/Pal	Qm/Pal	Kg/Kart	Kg/Pal
Tamaño	Piezas/Caja	Piezas/Pal	Mq/Caja	Caja/Pal	Mq/Pal	Kg/Caja	Kg/Pal
<b>100x300</b>	-	<b>13</b>	-	-	<b>39 (13 pz)</b>	<b>37,7</b>	<b>490,1</b>
<b>100x100</b>	<b>2</b>	<b>50</b>	<b>2,0</b>	<b>25</b>	<b>50</b>	<b>27,2</b>	<b>680,0</b>
<b>50x150</b>	<b>2</b>	<b>80</b>	<b>1,5</b>	<b>40</b>	<b>60</b>	<b>20,7</b>	<b>828,0</b>

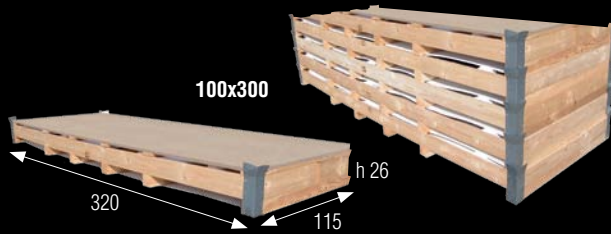

I formati 100x300 sono imballati accuratamente in vassoi di legno sovrapponibili (115x320xh26 cm) studiati per garantire l'integrità del prodotto (massimo 5 vassoi in colonna)\*

Il formato 100x100 e 50x150 sono imballati in fustelle di cartone collocate su appositi pallet sovrapponibili (110x110xh62 cm e 160x110xh56 cm)\*\*

\*Sizes 100x300 are carefully packaged on wooden crates that can be overlapped (115x320xh26 cm), suitably designed for a damage-free delivery. (max 5 crates overlapping).

\*\*Size 100x100 and 50x150 are packaged in cardboard sheets placed on suitable pallets that can be overlapped (110x110xh62 cm and 160x110xh56 cm).

\*Formaten 100x300 sind sorgfältig in stapelbaren Holzschalen (max. 5 Holzschalen hoch) verpackt (115x320xh26 cm), die derart entworfen sind, dass das Produkt garantiert keine Schaden erleidet.

\*\*Im Format 100x100 mm und 500x150 mm und in den kleineren Unterformaten werden Cerdisa Keramikplatten in Stanzkartons auf stapelbaren Paletten untergebracht (110x110xh62 cm und 160x110xh56 cm).

\*Les formats 100x300 sont emballés dans des plateaux en bois (115x320xh26 cm) étudiés pour garantir l'intégrité du produit (il est possible empiler les plateaux formant une colonne de maximum 5 plateaux).

\*\*Le format 100x100 e 50x150 sont emballés dans des découpes en carton placées sur des palettes superposables ad hoc (110x110xh62 cm et 160x110xh56).

City AN Lapp. Rett. 100x300  
Farringdon BI Lapp. Rett. 100x100

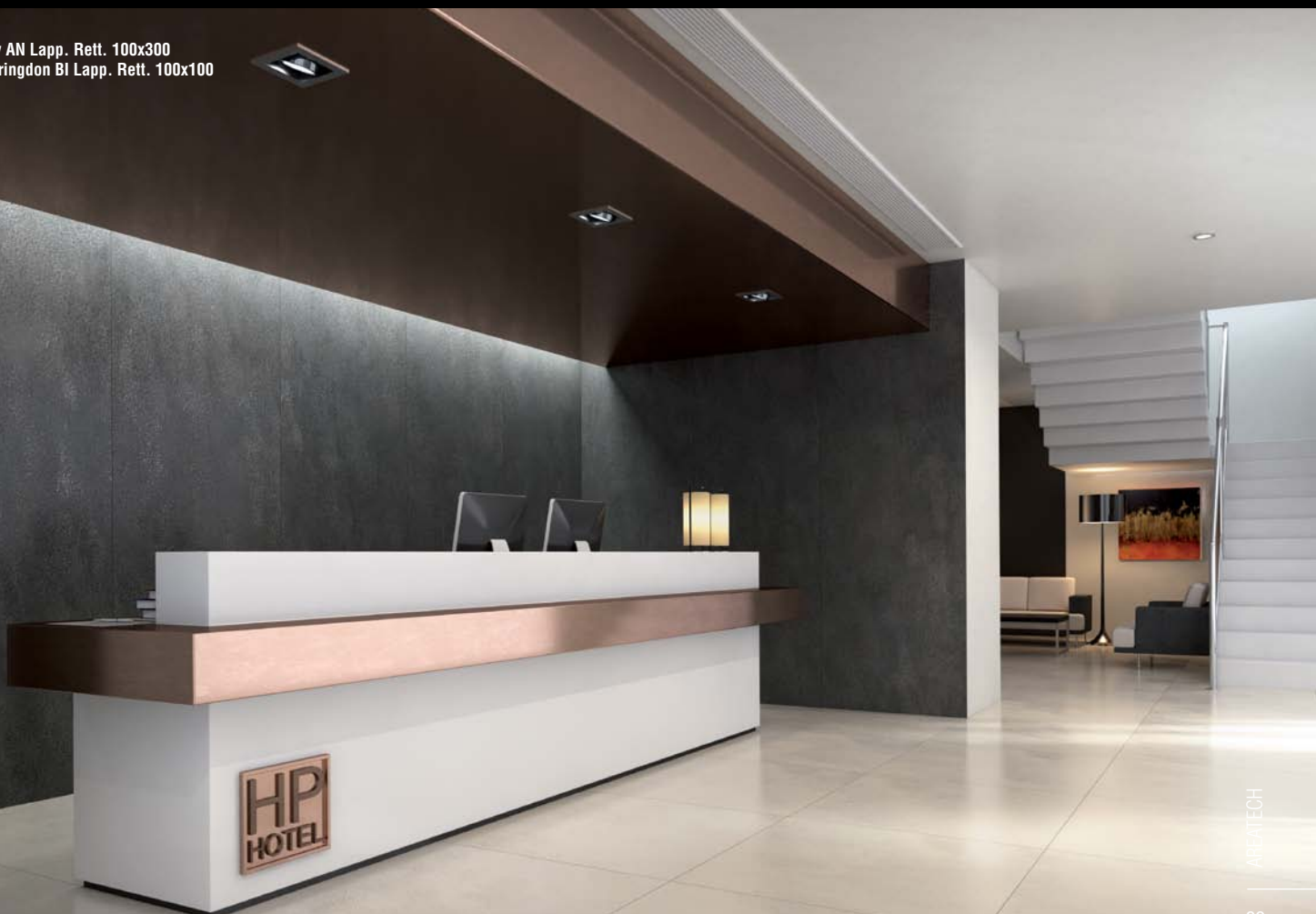

# FORMWORK

Gres fine porcellanato Bla UGL EN 14411 / Fine porcelain stoneware / Feinsteinzeug / Grès cérame fin / Gres fino porcelánico



Ash Nat. Rett. 30x120  
Gainsboro Nat. Rett. 30x120  
Decoro Geometrico Grigio 30x30  
Decoro Geometrico Mix Rosso/Grigio 30x120  
Decoro Geometrico Rosso 30x120



Juta Grip 30x120  
Almond Nat. Rett. 60x120



Greige Nat. Rett. 30x120 / 15x120 / 20x80



Gainsboro Nat. Rett. 20x80  
Gainsboro Grip 20x80



White Nat. Rett. 15x120

**Formati / Sizes / Grösse / Format / Tamaño:**



60x120 Rett.  
24"x48"



30x120 Rett.  
12"x48"



15x120 Rett.  
6"x48"



40x80 Rett.  
16"x32"



20x80 Rett.  
8"x32"

**Superfici / Surface / Oberfläche / Surface / Superficie**

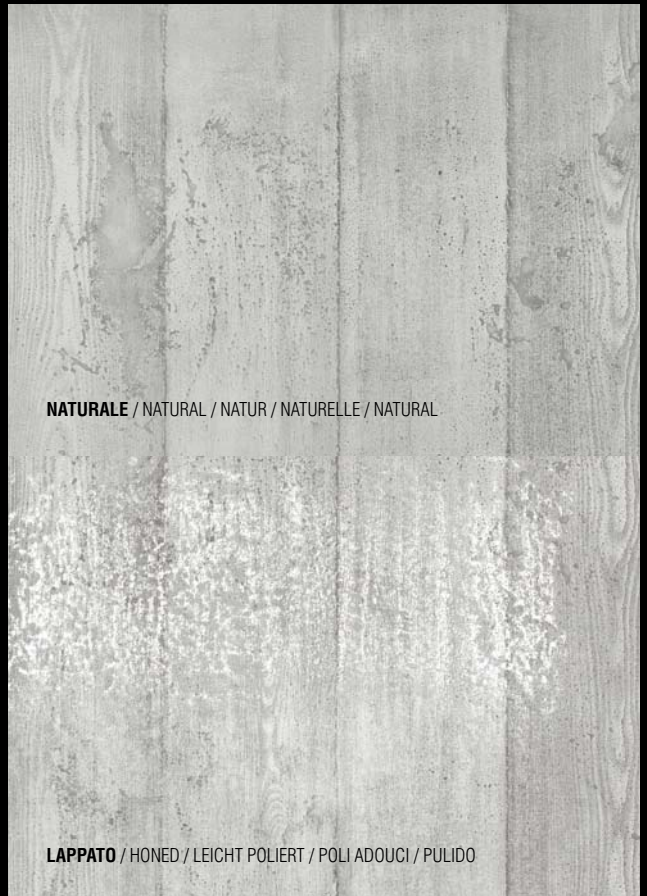

**NATURALE** / NATURAL / NATUR / NATURELLE / NATURAL

**LAPPATO** / HONED / LEICHT POLIERT / POLI ADOUCI / PULIDO



**GRIP** / GRIP SURFACE / SURFACE GRIP / GRIFFIGE OBERFLÄCHE / SUPERFICIE ANTIDESLIZANTE

# FORMWORK

Gres fine porcellanato Bla UGL EN 14411 / Fine porcelain stoneware / Feinsteinzeug / Grès cérame fin / Gres fino porcelánico



Gainsboro Nat. Rett. 30x120  
Ash Nat. Rett. 15x120  
Decoro Geometrico Rosso / Grigio / Mix Rett. 30x30



Juta Grip 30x120  
Almond Nat. Rett. 60x120

60x120 / 30x120 / 15x120 / 40x80 / 20x80 - 24"x48" / 12"x48" / 6"x48" / 16"x32" / 8"x32"



Juta Lapp. Rett. 60x120  
Decoro Tappeto Rosso 30x120  
Almond Lapp. Rett. 30x120



Gainsboro Nat. Rett. 60x120  
Gainsboro Lapp. Rett. 30x120

# FORMWORK

Gres fine porcellanato Bla UGL EN 14411 / Fine porcelain stoneware / Feinsteinzeug / Grès cérame fin / Gres fino porcelánico



Almond Nat. Rett. 15x120



Greige Nat. Rett. 30x120 / 15x120 / 20x80 / 40x80  
Mos. Sfalsato Greige 30x60

60x120 / 30x120 / 15x120 / 40x80 / 20x80 - 24"x48" / 12"x48" / 6"x48" / 16"x32" / 8"x32"



White Nat. Rett. 60x120  
Ash Nat. Rett. 60x120 / 30x120 / 15x120



Ash Nat. Rett. 60x120  
White Nat. Rett. 30x120  
Mosaico White 30x30



Greige Nat. Rett. 20x80  
Mosaico Stalsato Greige 30x60



# FORMWORK

Gres fine porcellanato Bla UGL EN 14411 / Fine porcelain stoneware / Feinsteinzeug / Grès cérame fin / Gres fino porcelánico



Grip R11 A+B+C > 0,60 dry / > 0,60 wet

White

Gainsboro

Ash

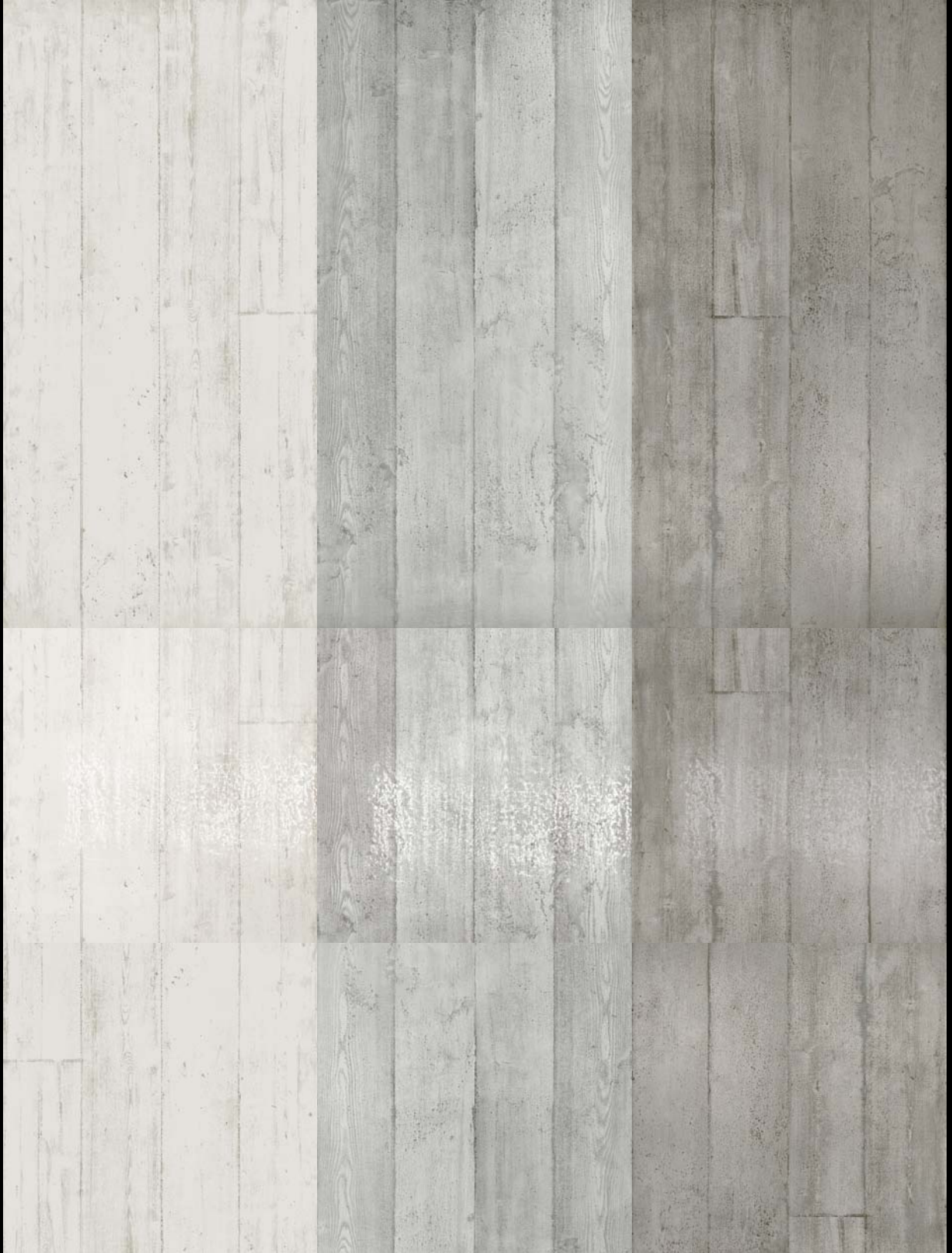

**NATURALE**  
NATURAL / NATUR / NATURELLE / NATURAL

**LAPPATO**  
HONED / LEICHT POLIERT / POLI ADOLCI / PULIDO

**GRIP**  
GRIP / GRIFFIGE OBERFLÄCHE / ANTIDESLIZANTE

Almond

Greige

Juta



**MATURALE**  
NATURAL / NATUR / NATURELLE / NATURAL

**LAPPATO**  
HONED / LEICHT POLIERT / POLI ADOLCI / PULIDO

**GRIP**  
GRIP / GRIFFIGE OBERFLÄCHE / ANTIDESLIZANTE

# FORMWORK

Gres fine porcellanato Bla UGL EN 14411 / Fine porcelain stoneware / Feinsteinzeug / Grès cérame fin / Gres fino porcelánico



Grip R11 A+B+C > 0,60 dry / > 0,60 wet



60x120 Rett.  
24"x48"



30x120 Rett.  
12"x48"



15x120 Rett.  
6"x48"



40x80 Rett.  
16"x32"



20x80 Rett.  
8"x32"



BATTISCOPA  
9,5x120  
4"x48"  
6 pcs x box



ELEMENTO L  
60x15x4  
24"x6<sup>3/4</sup>"x1<sup>2/8</sup>"  
4 pcs x box



GRADONE  
COSTA RETTA  
33x120x4x2,5  
13"x48"x1<sup>2/8</sup>"x1"  
2 pcs x box



ANG. GRADONE COSTA RETTA  
33x120x4x2,5  
13"x48"x1<sup>2/8</sup>"x1"  
2 pcs x box

## NATURALE

NATURAL / NATUR / NATURELLE / NATURAL

White	0051101	0051102	0051103	0051301	0051302
Gainsboro	0051201	0051202	0051203	0051401	0051402
Ash	0051231	0051232	0051233	0051431	0051432
Almond	0051141	0051142	0051143	0051341	0051342
Greige	0051171	0051172	0051173	0051371	0051372
Juta	0051261	0051262	0051263	0051461	0051462

## LAPPATO

HONED / LEICHT POLIERT / POLI ADOUCI / PULIDO

White	0051104	0051105	0051106	0051303	0051304
Gainsboro	0051204	0051205	0051206	0051403	0051404
Ash	0051234	0051235	0051236	0051433	0051434
Almond	0051144	0051145	0051146	0051343	0051344
Greige	0051174	0051175	0051176	0051373	0051374
Juta	0051264	0051265	0051266	0051463	0051464

## GRIP

GRIP SURFACE / GRIFFIGE OBERFLÄCHE / SURFACE GRIP / SUPERFICIE ANTIDESLIZANTE

White	0051137	0051138	0051139	0051337	0051338
Gainsboro	0051227	0051228	0051229	0051427	0051428
Ash	0051257	0051258	0051259	0051457	0051458
Almond	0051167	0051168	0051169	0051367	0051368
Greige	0051197	0051198	0051199	0051397	0051398
Juta	0051297	0051298	0051299	0051497	0051498

0051550	-	0051530	0051520	0051540
0051553	-	0051533	0051523	0051543
0051554	-	0051534	0051524	0051544
0051551	-	0051531	0051521	0051541
0051552	-	0051532	0051522	0051542
0051555	-	0051535	0051525	0051545

0051640	-	-	-	-
0051643	-	-	-	-
0051644	-	-	-	-
0051641	-	-	-	-
0051642	-	-	-	-
0051645	-	-	-	-

-	0051590	-	-	-
-	0051593	-	-	-
-	0051594	-	-	-
-	0051591	-	-	-
-	0051592	-	-	-
-	0051595	-	-	-

## ELEMENTO A L



## GRADONE COSTA RETTA



## Imballi / Packing / Verpackungen / Embalajes / Embalajes

Formato	Pezzi/Sc.	Mq/Sc	Sc/Pal	Mq/Pal	Kg/Sc	Kg/Pal
Size	Pcs/Box	Sq./M/Box	Box/Pal	Sq./M/Pal	Kg/Box	Kg/Pal
Größe	Pcs/Ctn	Mq/Ctn	Ctn/Pal	Mq/Pal	Kg/Ctn	Kg/Pal
Format	Stck/Kart	Qm/Kart	Kart/Pal	Qm/Pal	Kg/Kart	Kg/Pal
Tamaño	Piezas/Caja	Mq/Caja	Caja/Pal	Mq/Pal	Kg/Caja	Kg/Pal
60x120	2	1,44	18	25,92	36,00	648,00
30x120	4	1,44	18	25,92	36,00	648,00
15x120	7	1,26	24	30,24	31,30	751,20
40x80	3	0,96	56	53,76	23,70	1327,20
20x80	7	1,12	48	53,76	27,50	1320,00

## LISTONE GEOMETRICO 30x120



Listone Geometrico Grigio Rett.  
30x120 - 12"x48" / 2 pcs x box  
**0051623**



Listone Geometrico Rosso Rett.  
30x120 - 12"x48" / 2 pcs x box  
**0051622**



Listone Geometrico Mix Rosso/Grigio Rett.  
30x120 - 12"x48" / 2 pcs x box  
**0051624**

## DECORO GEOMETRICO 30x30\*



Decoro Geometrico Grigio Rett.  
30x30 - 12"x12" / 4 mixed pcs x box  
**0051626**

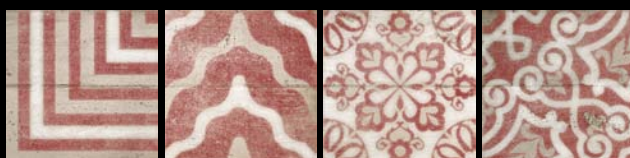

Decoro Geometrico Rosso Rett.  
30x30 - 12"x12" / 4 mixed pcs x box  
**0051625**



Decoro Geometrico Mix Rosso/Grigio Rett.  
30x30 - 12"x12" / 4 mixed pcs x box  
**0051627**

## LISTONE TAPPETO 30x120



Listone Tappeto Rosso Mix Rett.  
30x120 - 12"x48" / 2 pcs x box  
**0051620**



Listone Tappeto Azzurro Mix Rett.  
30x120 - 12"x48" / 2 pcs x box  
**0051621**

**\* Tutti i decori GEOMETRICI 30x30 sono inscatolati mescolando in maniera casuale i disegni della piastrella.**

\* All the GEOMETRICI 30x30 decoratives pieces are boxed randomly to mix the patterns on the tiles.

\* Beim Verpacken aller Dekore GEOMETRICI 30x30 wurden die Zeichnungen der Fliese nach dem Zufallsprinzip gemischt.

\* Tous les décors GEOMETRICI 30x30 sont mis en boîte en mélangeant de manière aléatoire les motifs du carrelage.

\* Todas las decoraciones GEOMETRICI 30x30 se presentan en estuches con los dibujos de la baldosa mezclados al azar.

**Gainsboro Nat. Rett. 30x120**  
**Decoro Geometrico Mix Rosso/Grigio 30x120**  
**Decoro Geometrico Rosso 30x120**



Gres fine porcellanato Bla UGL EN 14411 / Fine porcelain stoneware / Feinsteinzeug / Grès cérame fin / Gres fino porcelánico



## MOSAICO SFALSATO 30x60



Mosaico Sfalsato White Nat.  
30x60 - 12"x24" / 4 pcs x box  
**0051610**



Mosaico Sfalsato White Lapp.  
30x60 - 12"x24" / 4 pcs x box  
**0051670**



Mosaico Sfalsato Gainsboro Nat.  
30x60 - 12"x24" / 4 pcs x box  
**0051613**



Mosaico Sfalsato Gainsboro Lapp.  
30x60 - 12"x24" / 4 pcs x box  
**0051673**



Mosaico Sfalsato Ash Nat.  
30x60 - 12"x24" / 4 pcs x box  
**0051614**



Mosaico Sfalsato Ash Lapp.  
30x60 - 12"x24" / 4 pcs x box  
**0051674**



Mosaico Sfalsato Almond Nat.  
30x60 - 12"x24" / 4 pcs x box  
**0051611**



Mosaico Sfalsato Almond Lapp.  
30x60 - 12"x24" / 4 pcs x box  
**0051671**



Mosaico Sfalsato Greige Nat.  
30x60 - 12"x24" / 4 pcs x box  
**0051612**



Mosaico Sfalsato Greige Lapp.  
30x60 - 12"x24" / 4 pcs x box  
**0051672**



Mosaico Sfalsato Juta Nat.  
30x60 - 12"x24" / 4 pcs x box  
**0051615**



Mosaico Sfalsato Juta Lapp.  
30x60 - 12"x24" / 4 pcs x box  
**0051675**

## MOSAICO 30x30

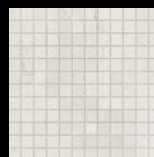

Mosaico White Nat.  
30x30 - 12"x12" / 4 pcs x box  
**0051600**

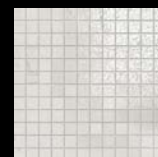

Mosaico White Lapp.  
30x30 - 12"x12" / 4 pcs x box  
**0051660**



Mosaico Gainsboro Nat.  
30x30 - 12"x12" / 4 pcs x box  
**0051603**

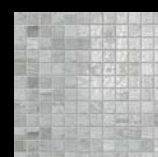

Mosaico Gainsboro Lapp.  
30x30 - 12"x12" / 4 pcs x box  
**0051663**

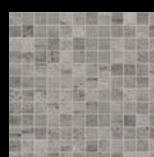

Mosaico Ash Nat.  
30x30 - 12"x12" / 4 pcs x box  
**0051604**



Mosaico Ash Lapp.  
30x30 - 12"x12" / 4 pcs x box  
**0051664**



Mosaico Almond Nat.  
30x30 - 12"x12" / 4 pcs x box  
**0051601**



Mosaico Almond Lapp.  
30x30 - 12"x12" / 4 pcs x box  
**0051661**



Mosaico Greige Nat.  
30x30 - 12"x12" / 4 pcs x box  
**0051602**



Mosaico Greige Lapp.  
30x30 - 12"x12" / 4 pcs x box  
**0051662**



Mosaico Juta Nat.  
30x30 - 12"x12" / 4 pcs x box  
**0051605**



Mosaico Juta Lapp.  
30x30 - 12"x12" / 4 pcs x box  
**0051665**



Ash Nat. Rett. 60x120 / 30x120 / 15x120

# HAMADA

Gres porcellanato colorato in massa UGL EN 14411 B1a

Colorbody porcelain stoneware / Durghgefärbtes steinzeug / Grès cérame coloré dans le masse / Gres porcelánico coloreado en toda la masa



Gold 30x60



**0077363**  
Avorio 30x60

**Formati**  
Sizes / Grösse / Format / Tamaño:



30x60  
12"x24"

**0077365**  
Gold 30x60

**0077361**  
Castagno 30x60

**0077362**  
Nero 30x60



BATTISCOPA	TERMINALE L	GRAD. INCISO
7,5x30	16,5x30x5	30x60
3"x12"	5"x12" x12"	12"x24"
44 pcs x box	6 pcs x box	8 pcs x box

<b>Avorio</b>	<b>0077309</b>	<b>0077321</b>	<b>0077135</b>
<b>Gold</b>	<b>0077311</b>	<b>0077323</b>	<b>0077137</b>
<b>Castagno</b>	<b>0077307</b>	<b>0077319</b>	<b>0077133</b>
<b>Nero</b>	<b>0077308</b>	<b>0077320</b>	<b>0077134</b>

**Imballi / Packing / Verpackungen / Embalajes / Embalajes**

Formato	Pezzi/Sc.	Mq/Sc	Sc/Pal	Mq/Pal	Kg/Sc	Kg/Pal
Size	Pcs/Box	Sq.M/Box	Box/Pal	Sq.M/Pal	Kg/Box	Kg/Pal
Grösse	Pcs/Ctn	Mq/Ctn	Ctn/Pal	Mq/Pal	Kg/Ctn	Kg/Pal
Format	Stck/Kart	Qm/Kart	Kart/Pal	Qm/Pal	Kg/Kart	Kg/Pal
Tamaño	Piezas/Caja	Mq/Caja	Caja/Pal	Mq/Pal	Kg/Caja	Kg/Pal
<b>30x60</b>	<b>8</b>	<b>1,44</b>	<b>32</b>	<b>46,08</b>	<b>32,50</b>	<b>1040</b>



# PAVER

Gres fine porcellanato Bla UGL EN 14411 / Fine porcelain stoneware / Feinsteinzeug / Grès cérame fin / Gres fino porcelánico



Grigio 30x60



**0076054**  
Beige 30x60

**0076051**  
Rosso 30x60

**0076053**  
Brown 30x60

**0076052**  
Grigio Verde 30x60

**0076050**  
Grigio 30x60

Formati / Sizes / Grösse / Format / Tamaño:



30x60  
12"x24"



**BATTISCOPA**  
7,5x30  
3"x12"  
44 pcs x box

**GRADONE**  
30x60  
12"x24"  
8 pcs x box

Beige	<b>0076064</b>	<b>0076059</b>
Rosso	<b>0076061</b>	<b>0076056</b>
Brown	<b>0076063</b>	<b>0076058</b>
Grigio Verde	<b>0076062</b>	<b>0076057</b>
Grigio	<b>0076060</b>	<b>0076055</b>

Imballi / Packing / Verpackungen / Emballages / Embalajes

Formato	Pezzi/Sc.	Mq/Sc	Sc/Pal	Mq/Pal	Kg/Sc	Kg/Pal
Size	Pos/Box	Sq.M/Box	Box/Pal	Sq.M/Pal	Kg/Box	Kg/Pal
Grösse	Pos/Ctn	Mq/Ctn	Ctn/Pal	Mq/Pal	Kg/Ctn	Kg/Pal
Format	Stck/Kart	Qm/Kart	Kart/Pal	Qm/Pal	Kg/Kart	Kg/Pal
Tamaño	Piezas/Caja	Mq/Caja	Caja/Pal	Mq/Pal	Kg/Caja	Kg/Pal
<b>30x60</b>	<b>8</b>	<b>1.44</b>	<b>32</b>	<b>46.08</b>	<b>32.50</b>	<b>1040</b>

# PIETRA PIASENTINA

Gres fine porcellanato Bla UGL EN 14411 / Fine porcelain stoneware / Feinsteinzeug / Grès cérame fin / Gres fino porcelánico



New York Grigio Chiaro Rett. 39,6x79,4  
Grigio Chiaro Rett. 39,6x79,4  
Grigio Chiaro Rett. 19,7x79,4  
Fascia Mosaico Acciaio 4x30  
Grigio Chiaro Grip 40x80,3



New York Antracite Rett. 39,6x79,4 / 13x79,4



New York Cacao Rett. 39,6x79,4  
Matita Onda Bronzo 2,5x59,8  
Cacao Rett. 19,7x79,4



**Formati / Sizes / Grösse / Format / Tamaño:**



40x80,3  
39,6x79,4 Rett.  
16"x32"



19,7x79,4 Rett.  
8"x32"



13x79,4 Rett.  
5"x32"



19,7x39,6 Rett.  
8"x16"

**Superfici / Surface / Oberfläche / Surface / Superficie**

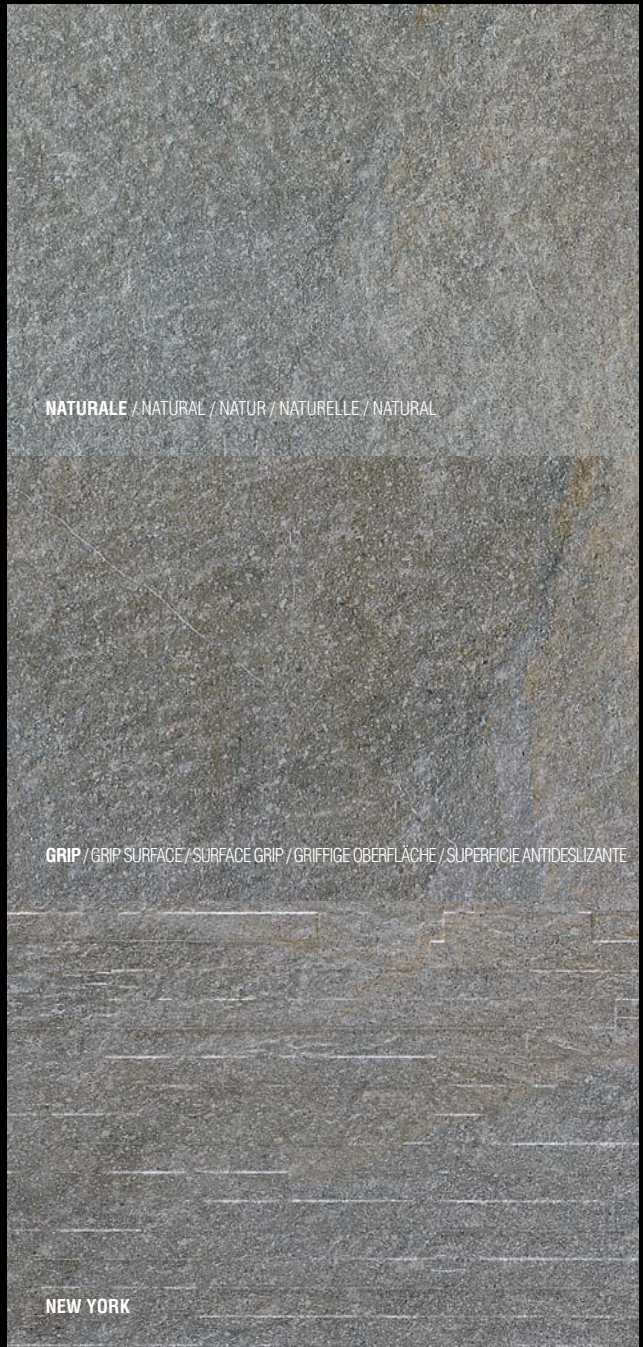

# PIETRA PIASENTINA

Gres fine porcellanato Bla UGL EN 14411 / Fine porcelain stoneware / Feinsteinzeug / Grès cérame fin / Gres fino porcelánico



Nat.

Grip

Grigio Chiaro

Grigio

Antracite

Beige

Cacao

**NATURALE**  
NATURAL / NATUR / NATURELLE / NATURAL

**NEW YORK**

**GRIP**  
GRIP / GRIP / GRIFFIGE OBERFLÄCHE / ANTIDESLIZANTE



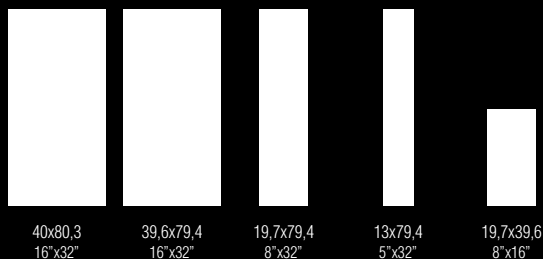

**NATURALE**

NATURAL / NATUR / NATURELLE / NATURAL

<b>Grigio Chiaro</b>	<b>0800420</b>	<b>0800421</b>	<b>0800423</b>	-	<b>0800428</b>	<b>0800431</b>	<b>0800438</b>	<b>0800436</b>	<b>0800439</b>	<b>0800437</b>
<b>Grigio</b>	<b>0800340</b>	<b>0800341</b>	<b>0800343</b>	-	<b>0800348</b>	<b>0800351</b>	<b>0800358</b>	<b>0800356</b>	<b>0800359</b>	<b>0800357</b>
<b>Antracite</b>	<b>0800480</b>	<b>0800481</b>	<b>0800483</b>	-	<b>0800488</b>	<b>0800491</b>	<b>0800498</b>	<b>0800496</b>	<b>0800499</b>	<b>0800497</b>
<b>Beige</b>	<b>0800400</b>	<b>0800401</b>	<b>0800403</b>	-	<b>0800408</b>	<b>0800411</b>	<b>0800418</b>	<b>0800416</b>	<b>0800419</b>	<b>0800417</b>
<b>Cacao</b>	<b>0800460</b>	<b>0800461</b>	<b>0800463</b>	-	<b>0800468</b>	<b>0800471</b>	<b>0800478</b>	<b>0800476</b>	<b>0800479</b>	<b>0800477</b>

**GRIP**

GRIP SURFACE / GRIFFIGE OBERFLÄCHE / SURFACE GRIP / SUPERFICIE ANTIDESLIZANTE

<b>Grigio Chiaro</b>	<b>0800429</b>	-	-	-	-	-	-	-	-	-
<b>Grigio</b>	<b>0800349</b>	-	-	-	-	-	-	-	-	-
<b>Antracite</b>	<b>0800489</b>	-	-	-	-	-	-	-	-	-
<b>Beige</b>	<b>0800409</b>	-	-	-	-	-	-	-	-	-
<b>Cacao</b>	<b>0800469</b>	-	-	-	-	-	-	-	-	-

**NEW YORK**

<b>Grigio Chiaro</b>	<b>0800425</b>	<b>0800426</b>	-	<b>0800427</b>	-	-	-	-	-	-
<b>Grigio</b>	<b>0800345</b>	<b>0800346</b>	-	<b>0800347</b>	-	-	-	-	-	-
<b>Antracite</b>	<b>0800485</b>	<b>0800486</b>	-	<b>0800487</b>	-	-	-	-	-	-
<b>Beige</b>	<b>0800405</b>	<b>0800406</b>	-	<b>0800407</b>	-	-	-	-	-	-
<b>Cacao</b>	<b>0800465</b>	<b>0800466</b>	-	<b>0800467</b>	-	-	-	-	-	-

**Imballi / Packing / Verpackungen / Emballages / Embalajes**

Formato	Pezzi/Sc.	Mq/Sc	Sc/Pal	Mq/Pal	Kg/Sc	Kg/Pal
Size	Pcs/Box	Sq.M/Box	Box/Pal	Sq.M/Pal	Kg/Box	Kg/Pal
Größe	Pcs/Ctn	Mq/Ctn	Ctn/Pal	Mq/Pal	Kg/Ctn	Kg/Pal
Format	Stk/Kart	Qm/Kart	Kart/Pal	Qm/Pal	Kg/Kart	Kg/Pal
Tamaño	Piezas/Caja	Mq/Caja	Caja/Pal	Mq/Pal	Kg/Caja	Kg/Pal
<b>40x80,3</b>	<b>4</b>	<b>1,28</b>	<b>48</b>	<b>61,92</b>	<b>27,60</b>	<b>1324,80</b>
<b>39,6x79,4</b>	<b>4</b>	<b>1,26</b>	<b>48</b>	<b>60,80</b>	<b>27,00</b>	<b>1296,00</b>
<b>19,7x79,4</b>	<b>8</b>	<b>1,25</b>	<b>48</b>	<b>60,00</b>	<b>27,60</b>	<b>1324,80</b>
<b>19,7x39,6</b>	<b>16</b>	<b>1,25</b>	<b>48</b>	<b>60,00</b>	<b>26,70</b>	<b>1281,60</b>
<b>13x79,4</b>	<b>12</b>	<b>1,24</b>	<b>54</b>	<b>66,96</b>	<b>26,50</b>	<b>1431,00</b>

**Beige Rett. 39,6x79,4 / 19,7x79,4**  
**New York Cacao Rett. 39,6x79,4**  
**New York Beige Rett. 39,6x79,4**  
**Cacao Rett. 19,7x79,4**



# PIETRAFORTE

Gres fine porcellanato Bia UGL EN 14411 / Fine porcelain stoneware / Feinsteinzeug / Grès cérame fin / Gres fino porcelánico

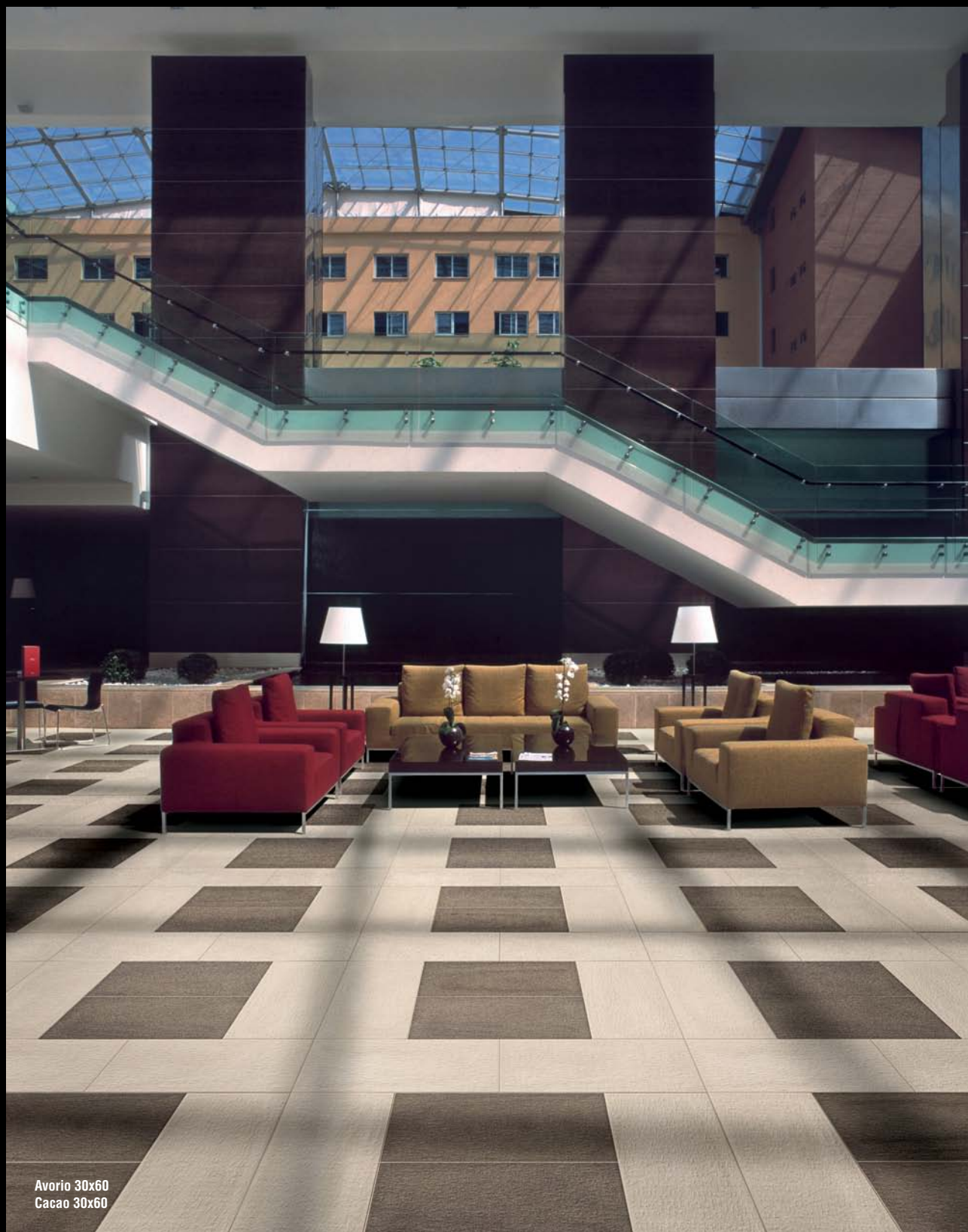

Avorio 30x60  
Cacao 30x60



Antracite 30x60



Grigio 30x60

Formati / Sizes / Größe / Format / Tamaño:



30x60  
12"x24"



Antracite 30x60



# PIETRAFORTE

30x60 - 12"x24"

Gres fine porcellanato Bla UGL EN 14411 / Fine porcelain stoneware / Feinsteinzeug / Grès cérame fin / Gres fino porcelánico



30x60	Classement			
	U	P	E	C
	U4	P3	E3	C2
				S

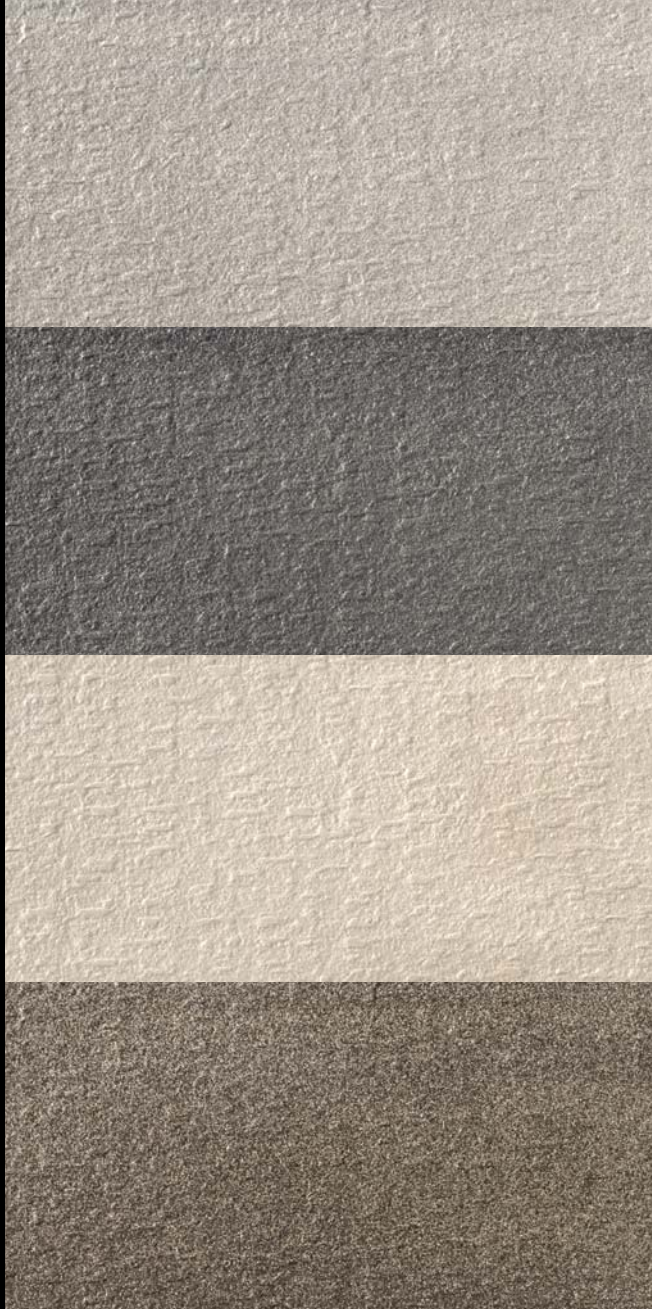

**0076000**  
Grigio 30x60

**0076001**  
Antracite 30x60

**0076003**  
Avorio 30x60

**0076002**  
Cacao 30x60



<b>BATTISCOPA</b>	<b>7.5x30</b>	<b>3"x12"</b>	<b>44 pcs x box</b>
<b>GRADONE</b>	<b>30x60</b>	<b>12"x24"</b>	<b>8 pcs x box</b>
<b>Grigio</b>	<b>0076008</b>	<b>0076004</b>	
<b>Antracite</b>	<b>0076009</b>	<b>0076005</b>	
<b>Avorio</b>	<b>0076011</b>	<b>0076007</b>	
<b>Cacao</b>	<b>0076010</b>	<b>0076006</b>	

## Imballi / Packing / Verpackungen / Emballages / Embalajes

Formato	Pezzi/Sc.	Mq/Sc	Sc/Pal	Mq/Pal	Kg/Sc	Kg/Pal
Size	Pcs/Box	Sq.M/Box	Box/Pal	Sq.M/Pal	Kg/Box	Kg/Pal
Größe	Pcs/Ctn	Mq/Ctn	Ctn/Pal	Mq/Pal	Kg/Ctn	Kg/Pal
Format	Stck/Kart	Qm/Kart	Kart/Pal	Qm/Pal	Kg/Kart	Kg/Pal
Tamaño	Piezas/Caja	Mq/Caja	Caja/Pal	Mq/Pal	Kg/Caja	Kg/Pal
<b>30x60</b>	<b>8</b>	<b>1.44</b>	<b>32</b>	<b>46.08</b>	<b>32.50</b>	<b>1040</b>



Grigio 30x60  
Antracite 30x60

# PORTLAND

Gres fine porcellanato Bia UGL EN 14411 / Fine porcelain stoneware / Feinsteinzeug / Grès cérame fin / Gres fino porcelánico





**Formati / Sizes / Grösse / Format / Tamaño:**



60,8x60,8  
59,8x59,8 Rett.  
24"x24"



30x80  
30x60 Rett.  
12"x24"



15x60 Rett.  
6"x24"



45x45  
45x45 Rett.  
18"x18"

**Superfici / Surface / Oberfläche / Surface / Superficie**

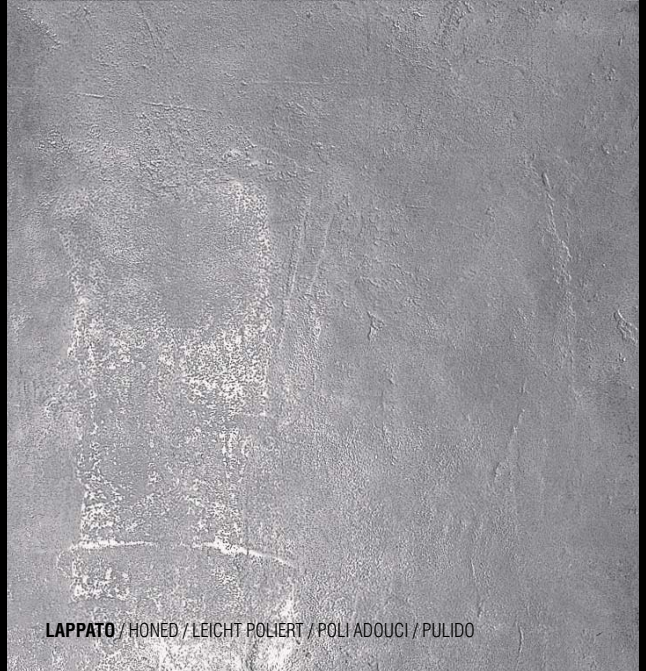
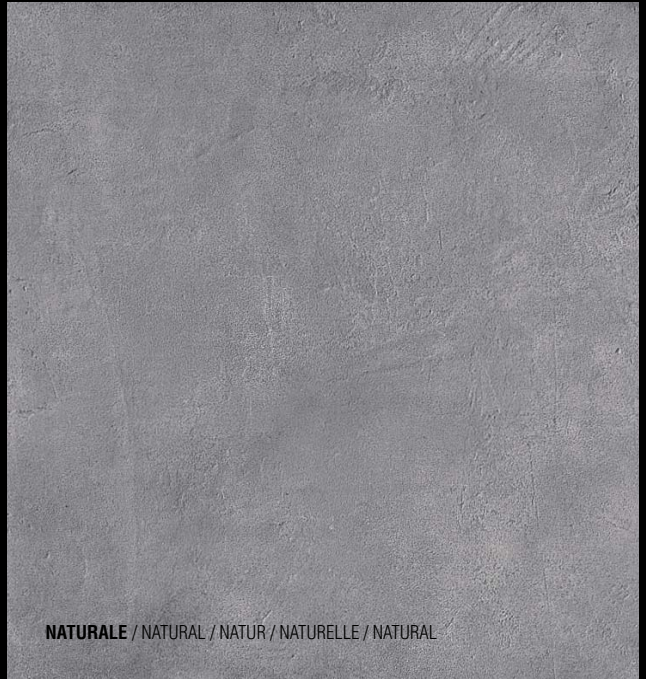

# PORTLAND

Gres fine porcellanato Bla UGL EN 14411 / Fine porcelain stoneware / Feinsteinzeug / Grès cérame fin / Gres fino porcelánico



Mosaico Grigio Azzurro 30x30  
Listello Alluminio 1x45  
Grigio Azzurro 45x45



Grigio Chiaro Rett. Lapp. 30x60



Avorio Rett. Lapp. 59,8x59,8

60,8x60,8 / 59,8x59,8 / 45x45 / 30x60 / 15x60 - 24"x24" / 12"x24" / 6"x24" / 18"x18"



Tortora Rett. Lapp. 59,8x59,8



Beige Rett. Lapp. 45x45  
Beige Rett. Lapp. 30x60  
Beige Rett. Lapp. 15x60



Mosaico Beige Lapp. 30x30  
Mosaico Bronzo Lapp. 30x30  
Treccia Mix Rett. 2,5x5 3x29,6  
Beige Rett. Lapp. 30x60  
Bronzo Rett. Lapp. 30x60

# PORTLAND

Gres fine porcellanato Bia UGL EN 14411 / Fine porcelain stoneware / Feinsteinzeug / Grès cérame fin / Gres fino porcelánico



Avorio

Grigio Chiaro

Grigio Azzurro

Grigio Scuro

NATURALE  
LAPPATO  
HONED / LEICHT POLIERT / LAPPATO / PULIDO  
NATURAL / NATUR / NATURELLE / NATURAL



60,8x60,8  
24"x24"



60x60 rett.  
24"x24"



45x45  
18"x18"



45x45 rett.  
18"x18"



30x60  
12"x24"



30x60 rett.  
12"x24"



15x60 rett.  
6"x24"



## NATURALE

NATURAL / NATUR / NATURELLE / NATURAL

Avorio	0050196	0050197	-	-	0077896	0077897	-
Grigio Chiaro	0050171	0050181	0077546	0077606	0077536	0077601	-
Grigio Azzurro	0050172	0050182	0077547	0077607	0077537	0077602	-
Grigio Scuro	0050190	0050191	-	-	0077890	0077891	-
Beige	0050170	0050180	0077545	0077605	0077535	0077600	-
Tortora	0050193	0050194	-	-	0077893	0077894	-
Bronzo	0050173	0050183	0077548	0077608	0077538	0077603	-

## LAPPATO

HONED / LEICHT POLIERT / POLI ADOUCI / PULIDO

Avorio	-	0050198	-	-	-	0077898	-
Grigio Chiaro	-	0050186	-	0077616	-	0077611	0077609
Grigio Azzurro	-	0050187	-	0077617	-	0077612	0077614
Grigio Scuro	-	0050192	-	-	-	0077892	-
Beige	-	0050185	-	0077615	-	0077610	0077604
Tortora	-	0050195	-	-	-	0077895	-
Bronzo	-	0050188	-	0077618	-	0077613	0077619

 	Classement					
	U	P	E	C	GeI	
	30x60 Nat./Lapp.	U4	P4	E3	C2	S
	45x45 Nat./Lapp.	U4	P4+	E3	C2	S
60x60 Nat./Lapp.	U4	P4+	E3	C2	S	

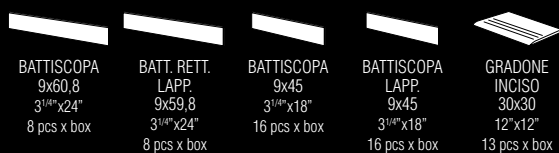

	BATTISCOPA 9x60,8 3 1/4" x 24" 8 pcs x box	BATT. RETT. LAPP. 9x59,8 3 1/4" x 24" 8 pcs x box	BATTISCOPA 9x45 3 1/4" x 18" 16 pcs x box	BATTISCOPA LAPP. 9x45 3 1/4" x 18" 16 pcs x box	GRADONE INCISO 30x30 12" x 12" 13 pcs x box
Avorio	0050164	0050167	-	-	0077628
Grigio Chiaro	0050168	0050169	0077377	0077367	0077621
Grigio Azzurro	0050184	0050199	0077378	0077368	0077622
Grigio Scuro	0050162	0050165	-	-	0077626
Beige	0050218	0050279	0077376	0077366	0077620
Tortora	0050163	0050166	-	-	0077627
Bronzo	0050248	0050289	0077379	0077369	0077623

Imballi / Packing / Verpackungen / Embalajes / Embalajes

Formato	Pezzi/Sc.	Mq/Sc	Sc/Pal	Mq/Pal	Kg/Sc	Kg/Pal
Size	Pcs/Box	Sq. M/Box	Box/Pal	Sq. M/Pal	Kg/Box	Kg/Pal
Grösse	Pcs/Ctn	Mq/Ctn	Ctn/Pal	Mq/Pal	Kg/Ctn	Kg/Pal
Format	Stck/Kart	Om/Kart	Kart/Pal	Om/Pal	Kg/Kart	Kg/Pal
Tamaño	Piezas/Caja	Mq/Caja	Caja/Pal	Mq/Pal	Kg/Caja	Kg/Pal
60,8x60,8	4	1,48	24	35,52	35,50	852,0
59,8x59,8 Rett.	4	1,43	24	34,32	34,50	828,0
45x45	8	1,62	44	71,28	36,05	1586,2
45x45 Rett.	8	1,62	44	71,28	34,60	1522,4
30x60	8	1,44	32	46,10	31,00	992,0
30x60 Rett.	8	1,44	32	46,08	30,50	976,0
15x60 Rett.	11	1,00	33	33,00	21,90	722,7



# PORTLAND

60,8x60,8 / 59,8x59,8 / 45x45 / 30x60 / 15x60 - 24"x24" / 12"x24" / 6"x24" / 18"x18"

Gres fine porcellanato Bla UGL EN 14411 / Fine porcelain stoneware / Feinsteinzeug / Grès cérame fin / Gres fino porcelánico



NF	UPEC	Classement			
		U	P	E	C
30x60 Nat./Lapp.	U4	P4	E3	C2	S
45x45 Nat./Lapp.	U4	P4+	E3	C2	S
60x60 Nat./Lapp.	U4	P4+	E3	C2	S



**0077477** Mosaico Grigio Chiaro  
30x30 - 12"x12"  
15 pcs x box



**0077478** Mosaico Grigio Azzurro  
30x30 - 12"x12"  
15 pcs x box



**0077476** Mosaico Beige  
30x30 - 12"x12"  
15 pcs x box



**0077479** Mosaico Bronzo  
30x30 - 12"x12"  
15 pcs x box



**0077473** Mosaico Grigio Chiaro Lapp.  
30x30 - 12"x12"  
15 pcs x box

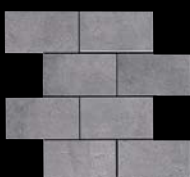

**0077474** Mosaico Grigio Azzurro Lapp.  
30x30 - 12"x12"  
15 pcs x box



**0077472** Mosaico Beige Lapp.  
30x30 - 12"x12"  
15 pcs x box



**0077475** Mosaico Bronzo Lapp.  
30x30 - 12"x12"  
15 pcs x box



**0077467** List. Madreperla vetro Bianco  
7,5x45 - 3"x18"  
6 pcs x box



**0077468** List. Madreperla vetro Beige  
7,5x45 - 3"x18"  
6 pcs x box



**0077567** Matita Alluminio44,6  
1x45 - 1/2"x18"  
8 pcs x box



**0077496** Fascia Grigio Chiaro Lapp.  
6x45 - 2 1/4"x18"  
6 pcs x box



**0077497** Fascia Grigio Azzurro Lapp.  
6x45 - 2 1/4"x18"  
6 pcs x box



**0077495** Fascia Beige Lapp.  
6x45 - 2 1/4"x18"  
6 pcs x box



**0077498** Fascia Bronzo Lapp.  
6x45 - 2 1/4"x18"  
6 pcs x box



**0077413** Angolo Grigio Chiaro Lapp.  
6x6 - 2 1/4"x 2 1/4"  
4 pcs x box



**0077418** Angolo Grigio Azzurro Lapp.  
6x6 - 2 1/4"x 2 1/4"  
4 pcs x box



**0077399** Angolo Beige Lapp.  
6x6 - 2 1/4"x 2 1/4"  
4 pcs x box



**0077419** Angolo Fascia Bronzo Lapp.  
6x6 - 2 1/4"x 2 1/4"  
4 pcs x box



# SANDSTONE

Gres fine porcellanato Bla UGL EN 14411 / Fine porcelain stoneware / Feinsteinzeug / Grès cérame fin / Gres fino porcelánico



Bianco 30x60 / 30x30 / 14,7x14,7



Antracite 30x30  
Fascia Grigio/Antracite 9x30  
Bianco 30x30



Antracite 45x45  
Mosaico Decorato Gold/Bianco



Grigio 30x60



Grigio 30x60

Formati / Sizes / Größe / Format / Tamaño:



30x60  
12"x24"



45x45  
18"x18"



14,7x45  
6"x18"



30x30  
12"x12"



14,7x14,7  
6"x6"



Gold 30x60 / 14,7x14,7

# SANDSTONE

Gres fine porcellanato Bia UGL EN 14411 / Fine porcelain stoneware / Feinsteinzeug / Grès cérame fin / Gres fino porcelánico



## Bianco

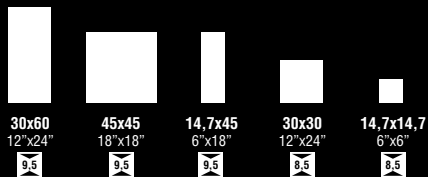

	<b>30x60</b> 12"x24"	<b>45x45</b> 18"x18"	<b>14,7x45</b> 6"x18"	<b>30x30</b> 12"x24"	<b>14,7x14,7</b> 6"x6"
	9,5	9,5	9,5	9,5	9,5
<b>Bianco</b>	<b>0077460</b>	<b>0077420</b>	<b>0077435</b>	<b>0077400</b>	<b>0077480</b>
<b>Grigio</b>	<b>0077463</b>	<b>0077423</b>	<b>0077438</b>	<b>0077403</b>	<b>0077483</b>
<b>Antracite</b>	<b>0077464</b>	<b>0077424</b>	<b>0077439</b>	<b>0077404</b>	<b>0077484</b>
<b>Gold</b>	<b>0077461</b>	<b>0077421</b>	<b>0077436</b>	<b>0077401</b>	<b>0077481</b>

## Gold

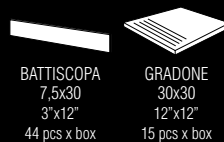

**BATTISCOPIA**  
7,5x30  
3"x12"  
44 pcs x box

**GRADONE**  
30x30  
12"x12"  
15 pcs x box

## Grigio

<b>Bianco</b>	<b>0077405</b>	<b>0077430</b>
<b>Grigio</b>	<b>0077408</b>	<b>0077433</b>
<b>Antracite</b>	<b>0077409</b>	<b>0077434</b>
<b>Gold</b>	<b>0077406</b>	<b>0077431</b>

## Antracite

Imballi / Packing / Verpackungen / Emballages / Embalajes

Formato	Pezzi/Sc.	Mq/Sc	Sc/Pal	Mq/Pal	Kg/Sc	Kg/Pal
Size	Pcs/Box	Sq./Box	Box/Pal	Sq./Pal	Kg/Box	Kg/Pal
Größe	Pcs/Ctn	Mq/Ctn	Ctn/Pal	Mq/Pal	Kg/Ctn	Kg/Pal
Format	Stck/Kart	Qm/Kart	Kart/Pal	Qm/Pal	Kg/Kart	Kg/Pal
Tamaño	Piezas/Caja	Mq/Caja	Caja/Pal	Mq/Pal	Kg/Caja	Kg/Pal
<b>30x60</b>	<b>8</b>	<b>1,44</b>	<b>32</b>	<b>46,08</b>	<b>32,50</b>	<b>1040,0</b>
<b>45x45</b>	<b>8</b>	<b>1,62</b>	<b>44</b>	<b>71,28</b>	<b>35,45</b>	<b>1559,8</b>
<b>30x30</b>	<b>15</b>	<b>1,35</b>	<b>40</b>	<b>54,00</b>	<b>27,50</b>	<b>1100,0</b>
<b>14,7x45</b>	<b>16</b>	<b>1,08</b>	-	-	<b>21,50</b>	-
<b>14,7x14,7</b>	<b>22</b>	<b>0,50</b>	<b>120</b>	-	<b>9,00</b>	<b>1080,0</b>



Classement

	U	P	E	C	Gel
30x30	U4	P4+	E3	C2	S
30x60 Antracite	U4	P4	E3	C2	S
30x60	U4	P4	E3	C2	S
45x45	U4	P4+	E3	C2	S



**0077425** Mosaico Bianco  
45x45 - 18"x18"  
4 pcs x box



**0077485** Mosaico Dec. Gold/Bianco  
30x30 - 12"x12"  
4 pcs x box



**0077412** Fascia Grigio/Antracite  
9x30 - 3 5/8"x12"  
8 pcs x box



**0077417** Angolo Grigio/Antracite  
15x45 - 6"x18"  
4 pcs x box



**0077428** Mosaico Grigio  
45x45 - 18"x18"  
4 pcs x box

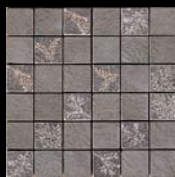

**0077487** Mosaico Dec. Grigio  
30x30 - 12"x12"  
4 pcs x box



**0077429** Mosaico Antracite  
45x45 - 18"x18"  
4 pcs x box



**0077488** Mosaico Dec. Antracite  
30x30 - 12"x12"  
4 pcs x box

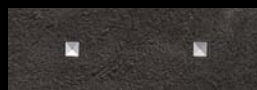

**0077444** Listello Borchie Antracite  
14,7x45 - 6"x18"  
6 pcs x box



**0077449** Tozz. Borchie Antracite  
14,7x14,7 - 6"x18"  
4 pcs x box



**0077426** Mosaico Gold  
45x45 - 18"x18"  
4 pcs x box



**0077359** List. Alluminio 3x45 - 1 1/4"x18"  
8 pcs x box

# STONE CULT

Gres fine porcellanato Bla UGL EN 14411 / Fine porcelain stoneware / Feinsteinzeug / Grès cérame fin / Gres fino porcelánico



Amber 40x80,3



	Classement				
	U	P	E	C	Gel
40x80 Nat.	U4	P3	E3	C2	S

**Formati / Sizes / Grösse / Format / Tamaño:**

**0040000**

Silver 40x80,3



40x80,3  
16"x32"

**0040005**

Grey 40x80,3

**0040010**

Amber 40x80,3

**0040015**

Cocoa 40x80,3

**Imballi / Packing / Verpackungen / Emballages / Embalajes**

Formato	Pezzi/Sc.	Mq/Sc	Sc/Pal	Mq/Pal	Kg/Sc	Kg/Pal
Size	Pos/Box	Sq.M/Box	Box/Pal	Sq.M/Pal	Kg/Box	Kg/Pal
Grösse	Pos/Ctn	Mq/Ctn	Ctn/Pal	Mq/Pal	Kg/Ctn	Kg/Pal
Format	Stck/Kart	Qm/Kart	Kart/Pal	Qm/Pal	Kg/Kart	Kg/Pal
Tamaño	Piezas/Caja	Mq/Caja	Caja/Pal	Mq/Pal	Kg/Caja	Kg/Pal
<b>40x80,3</b>	<b>3</b>	<b>0,97</b>	<b>56</b>	<b>54,32</b>	<b>24,0</b>	<b>1344,0</b>



# TINTE UNITE / GRANITI

Gres fine porcellanato Bla UGL EN 14411 / Fine porcelain stoneware / Feinsteinzeug / Grès cérame fin / Gres fino porcelánico

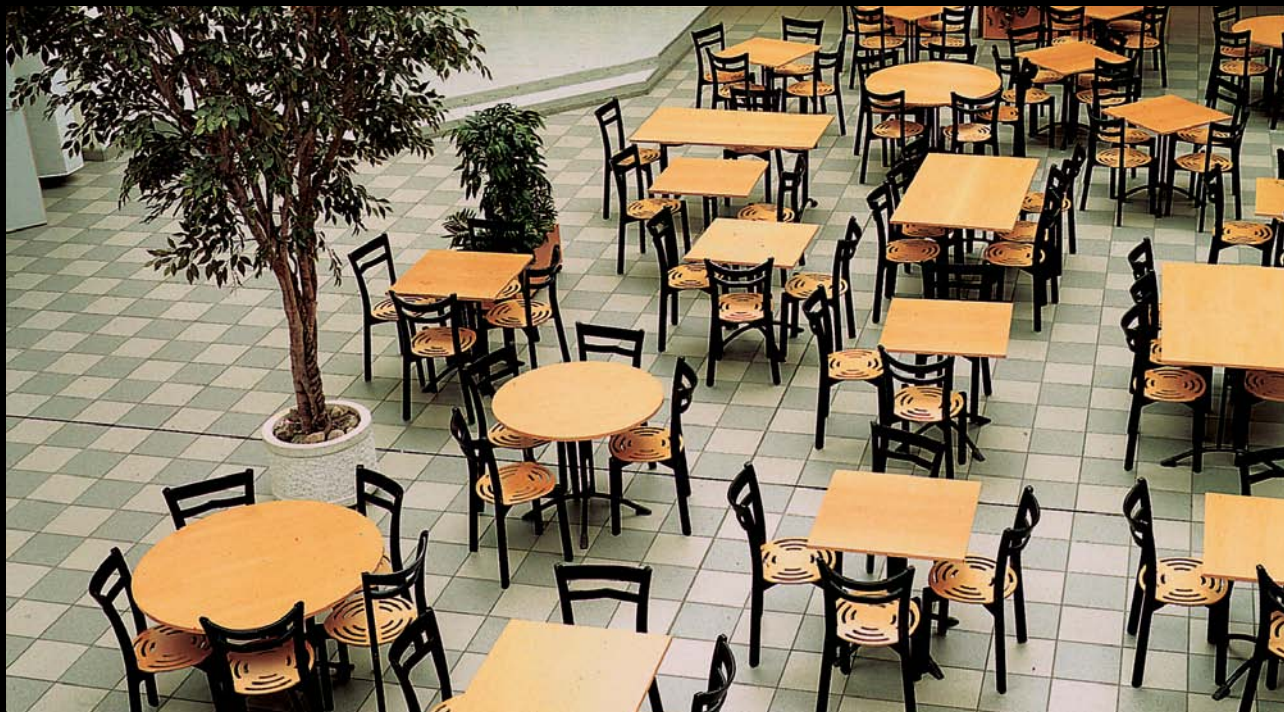

**SUPERFICI-SPessori / SURFACES-THICKNESS / OBERFLÄCHE-STÄRCKE / SURFACES-ÉPaisseur / SUPERFICIES-ESPESOR**

**NATURALE**  
R9



**NATURALE: Superficie liscia priva di qualsiasi trattamento superficiale.**

NATURAL: Smooth, untreated surface.  
BRUT: Surface lisse sans aucun traitement de surface  
NATUR: Glatte Oberfläche ohne zusätzliche Oberflächenbehandlungen.  
MATE: Superficie lisa carente de cualquier tratamiento superficial.

FORMATO SIZE DIMENSIONS MÄßEN FORMATO	SPESSORE THICKNESS ÉPaisseur STÄRCKE ESPESOR
30x30	7 mm 8 mm 12 mm
20x20	8 mm 12 mm
30x30	8 mm

**LEVIGATO**



**LEVIGATA: Superficie levigata e lucidata ad umido mediante utensili diamantati.**

POLISHED: Smooth, wet-polished surface achieved using diamond-tipped tools.  
POLI: Surface polie et lustrée par voie humide au moyen d'outils diamantés.  
GESCHLIFFEN: Mit Diamantwerkzeugen geschliffene und feuchtpolierte Oberfläche.  
PULIDO: Superficie pulida y lustrada en húmedo mediante herramientas adiamantadas.

**SLATE**  
R11 A+B



**SLATE: Superficie simile a quello delle pietre naturali lavorate a spacco. Buone caratteristiche antiscivolo.**

SLATE: Surface similar to that of natural cleft stone. Exceptional non-slip characteristics.  
SLATE: Surface semblable à celle des pierres naturelles fendues. Bonnes caractéristiques d'antigilissance.  
SLATE: Oberfläche ähnlich der Oberflächenstruktur von gebrochenen Natursteinen. Hohe Rutschfestigkeit.  
SLATE: Superficie parecida a la de las piedras naturales cortadas de manera irregular. Buenas características antideslizantes.

30x30	8 mm
20x20	8 mm

**CROSS R12 V4**  
R12



**CROSS R12 V4: Particolare trama a forma di croce trasferita meccanicamente a rilievo sul prodotto in fase di pressatura in grado di trasmettere elevate caratteristiche di resistenza ed antiscivolo.**

CROSS R12 V4: A special cross-shaped pattern mechanically embossed onto the product during the pressing phase making for an exceptionally resistant, non-slip surface.  
CROSS R12 V4: Trame particulière en forme de croix, imprimée en relief sur le produit en cours de pressage, au moyen de dispositifs mécaniques, lui donnant un haut degré de résistance et d'antigilissance.  
CROSS R12 V4: Besondere Struktur in Form eines Kreuzprofils, das während des Pressens mechanisch auf das Produkt aufgebracht wird und für eine hohe Beständigkeit und Rutschfestigkeit sorgt.  
CROSS R12 V4: Trama especial en forma de cruz transferida mecánicamente en relieve sobre el producto en fase de prensado capaz de transmitir elevadas características antideslizantes y de resistencia.

20x20	8 mm 12 mm
-------	---------------

SPESSORATI / EXTRA THICK MATERIALS / DICKENVERSTÄRKUNG / MATÉRIAUX À ÉPAISSEUR MAJORÉE / ESPESORADOS



## GRANITI

20x20 - 8"x8" / 30x30 - 12"x12"



Punto  
**0086376** 20x20  
**0086386** 20x20 cross R12V4  
**0081276** 30x30

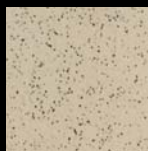

Bianco Alpi  
**0086305** 20x20  
**0086315** 20x20 cross R12V4  
**0081205** 30x30



Beige  
**0086301** 20x20  
**0086316** 20x20 cross R12V4  
**0081211** 30x30



Grigio  
**0086341** 20x20  
**0086317** 20x20 cross R12V4  
**0081241** 30x30

## TINTE UNITE

20x20 - 8"x8" / 30x30 - 12"x12"

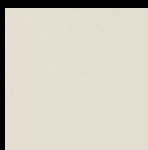

White  
**0086374** 20x20  
**0086384** 20x20 cross R12V4

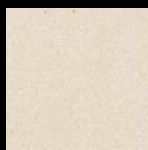

Bianco Ghiaccio  
**0081228** 30x30

# GRANITI

Gres fine porcellanato Bla UGL EN 14411 / Fine porcelain stoneware / Feinsteinzeug / Grès cérame fin / Gres fino porcelánico



## NATURALE / NATURAL / NATUR / NATURELLE / NATURAL



Punto	Bianco Alpi	Grigio	Grigio Granite	Grigio Scuro	Nero Macchiato
30x30 - 12"x12"	30x30 - 12"x12"	30x30 - 12"x12"	30x30 - 12"x12"	30x30 - 12"x12"	30x30 - 12"x12"
8 - 12 mm	8 - 12 mm	8 - 12 mm	8 mm	8 mm	8 mm
20x20 - 8"x8"	20x20 - 8"x8"	20x20 - 8"x8"	20x20 - 8"x8"	20x20 - 8"x8"	20x20 - 8"x8"
8 - 12 mm	8 - 12 mm	8 - 12 mm	8 mm	8 mm	8 mm

## LEVIGATO / POLISHED / POLIERT / POLI / PULIMENTADO



Punto Levigato	Bianco Alpi Levigato	Grigio Levigato	Grigio Granite Levigato	Grigio Scuro Levigato	Nero Macchiato Levigato
30x30 - 12"x12"	30x30 - 12"x12"	30x30 - 12"x12"	30x30 - 12"x12"	30x30 - 12"x12"	30x30 - 12"x12"
8 mm	8 mm	8 mm	8 mm	8 mm	8 mm

### GAMMA COLORI

RANGE OF COLORS  
GAMME DE COULEURS

FARBEN PALETTE  
GAMA DE COLORES



	30x30 12 mm	20x20 12 mm	R12 V4 20x20 12 mm	30x30 8 mm	Levigato 30x30 8 mm	Slate 30x30 8 mm	20x20 8 mm	Slate 20x20 8 mm	R12 V4 20x20 8 mm	Listello 10x30 pcs/box 30	Gradino inciso 30x30 pcs/box 15	Gradino Slate 30x30 pcs/box 15	Battiscopa con B.C. 8x30 pcs/box 30	Battiscopa Lev. 9,5x30 pcs/box 30	Battiscopa 10x30 pcs/box 30
PUNTO	0081276	0086376	0086386	0089612	0089112	-	0086612	-	-	-	0089012	-	0080812	-	0090812
BIANCO ALPI	0081205	0086305	0086315	0014305	0014405	0014355	0014005	0014055	0087305	0081805	0014505	0089905	0080805	0084105	0090805
GRIGIO	0081241	0086341	0086317	0089641	0089141	0089891	0086641	0086191	0087341	0081841	0089041	0089941	0080841	0084141	0090841
GRIGIO GRANITE	-	-	-	0089740	0089140	0089890	0086740	-	-	0081840	0089040	-	0080840	0084140	0090840
GRIGIO SCURO	-	-	-	0089642	0089142	0089892	0086642	0086192	0087362	0081842	0089042	0089942	0080842	0084142	0090842
NERO MACCHIATO	-	-	-	0089604	0089104	-	0086604	-	-	-	-	-	-	0084104	0090804
BEIGE	0081211	0086301	0086316	0089611	0089101	0089811	0086611	0086111	0087301	-	0089001	0089901	0080801	0084101	0090801
MANDORLA CON SPEZIA	-	-	-	0089655	0089155	-	0086655	-	-	-	-	-	-	-	0090855
ROSA ANTICO	-	-	-	0089756	0089156	-	0086756	-	-	0081856	0089056	-	0080856	0084156	0090856
VERDE ALGHERO	-	-	-	0014307	0014407	-	0014007	-	-	0081807	0014507	-	0080807	0084107	0090807
LABRADORITE	-	-	-	0089649	0089149	-	0086649	-	-	0081849	0089049	-	0080849	0084149	0090849

	Classement					
	U	P	E	C	GeI	
	30x30 = 12 mm	U4	P4+	E3	C2	S
	20x20 = 12 mm	U4	P4s	E3	C2	S
30x30 - 20x20 = 8 mm	U4	P4	E3	C2	S	

**NATURALE / NATURAL / NATUR / NATURELLE / NATURAL**



Beige	Mandorla con Spezia	Rosa Antico	Verde Alghero	Labradorite
30x30 - 12"x12" 8 - 12 mm	30x30 - 12"x12" 8 mm	30x30 - 12"x12" 8 mm	30x30 - 12"x12" 8 mm	30x30 - 12"x12" 8 mm
20x20 - 8"x8" 8 - 12 mm	20x20 - 8"x8" 8 mm	20x20 - 8"x8" 8 mm	20x20 - 8"x8" 8 mm	20x20 - 8"x8" 8 mm

**LEVIGATO / POLISHED / POLIERT / POLI / PULIMENTADO**



Beige Levigato	Mandorla con Spezia Levigato	Rosa Antico Levigato	Verde Alghero Levigato	Labradorite Levigato
30x30 - 12"x12" 8 mm	30x30 - 12"x12" 8 mm	30x30 - 12"x12" 8 mm	30x30 - 12"x12" 8 mm	30x30 - 12"x12" 8 mm

Battiscopa con B.C. 10x20 pcs/box 25	Term. SX 10x20 pcs/box 25	Term. DX 10x20 pcs/box 25	Sguscia B.C. 15x20 pcs/box 24	Angolo Int. B.C. H: 15 cm pcs/box 4	Angolo Est. B.C. H: 15 cm pcs/box 4	Sguscia B.C. 11x30 pcs/box 30	Angolo Int. B.C. H: 11 cm pcs/box 4	Angolo Est. B.C. H: 11 cm pcs/box 4	Sguscia "Flat Top" 11x20 pcs/box 30	Ang. Int. "Flat Top" H: 11 cm pcs/box 4	Ang. Est. "Flat Top" H: 11 cm pcs/box 4	Zoccolo Francese 10x30 pcs/box 30	Raccordo 5x20 pcs/box 30	Unghia 5x5 pcs/box 4	Piede 5x5 pcs/box 4
0080612	0083402	0080402	0082012	0082412	0082312	0081412	0082812	0082712	0081912	0082612	0082512	-	-	-	-
0014605	0083405	0080405	0082005	0082405	0082305	0081405	0082805	0082705	0081905	0082605	0082505	0081705	0083705	0083805	0083905
0080641	0083441	0080441	0082041	0082441	0082341	0081441	0082841	0082741	0081941	0082641	0082541	0081741	0083741	0083841	0083941
0080740	0083440	0080440	0082040	0082440	0082340	0081440	0082840	0082740	-	-	-	-	-	-	-
0080642	0083442	0080442	0082042	0082442	0082342	0081442	0082842	0082742	0081942	0082642	0082542	-	-	-	-
0080604	0083404	0080404	0082004	0082404	0082304	-	-	-	-	-	-	-	-	-	-
0080601	0083401	0080401	0082001	0082401	0082301	0081401	0082801	0082701	0081901	0082601	0082501	0081701	0083701	0083801	0083901
0080655	0083455	0080455	0082055	0082455	0082355	-	-	-	-	-	-	-	-	-	-
0080756	0083456	0080456	0082056	0082456	0082356	0081456	0082856	0082756	-	-	-	-	-	-	-
0014607	0083407	0080407	0082007	0082407	0082307	-	-	-	-	-	-	-	-	-	-
0080649	0083449	0080449	0082049	0082449	0082349	-	-	-	-	-	-	-	-	-	-

# TINTE UNITE

Gres fine porcellanato Bla UGL EN 14411 / Fine porcelain stoneware / Feinsteinzeug / Grès cérame fin / Gres fino porcelánico



	Classement			
	U	P	E	C
30x30 ≠ 12 mm	U4	P4+	E3	C2
20x20 ≠ 12 mm	U4	P4s	E3	C2
30x30 - 20x20 = 8 mm	U4	P4	E3	C2

## NATURALE / NATURAL / NATUR / NATURELLE / NATURAL



Bianco Ghiaccio	Bianco	Grigio	Nero	White
30x30 - 12"x12"	30x30 - 12"x12"	30x30 - 12"x12"	30x30 - 12"x12"	20x20 - 8"x8"
8 - 12 mm	8 mm	8 mm	8 mm	12 mm
20x20 - 8"x8"	8 mm			

## LEVIGATO / POLISHED / POLIERT / POLI / PULIMENTADO

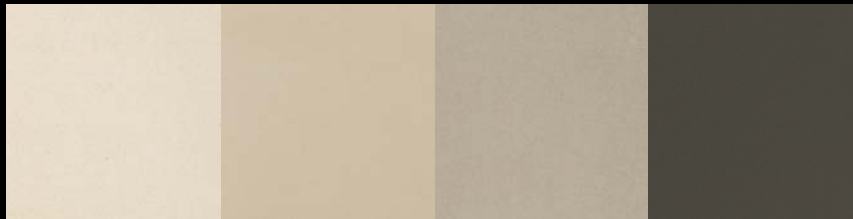

Bianco Ghiaccio Levigato	Bianco Levigato	Grigio Levigato	Nero Levigato
30x30 - 12"x12"	30x30 - 12"x12"	30x30 - 12"x12"	30x30 - 12"x12"
8 mm	8 mm	8 mm	8 mm

GAMMA COLORI	30x30	20x20	R12 V4	30x30	Levigato	20x20	Listello	Gradino
RANGE OF COLORS	12 mm	12 mm	20x20	8 mm	30x30	8 mm	10x30	30x30
GAMME DE COULEURS	12 mm	12 mm	12 mm	8 mm	8 mm	8 mm	pcs/box 30	pcs/box 15
FARBEN PALETTE								
GAMA DE COLORES								
BIANCO GHIACCIO	0081228	-	-	0089328	0089128	0086328	0081828	0087928
BIANCO	-	-	-	0089229	0089129	-	0081829	0087929
GRIGIO	-	-	-	0089213	0089113	-	-	0087913
NERO	-	-	-	0089311	0089111	-	0081811	0087911
WHITE		0086374	0086384	-	-	-	-	-

GAMMA COLORI	Battiscopa	Battiscopa	Battiscopa	Battiscopa	Term. SX	Term. DX	Sguscia	Angolo	Angolo	Sguscia	Angolo	Angolo	Zoccolo
RANGE OF COLORS	con B.C.	Lev.	10x30	con B.C.	10x20	10x20	B.C.	Int. B.C.	Est. B.C.	B.C.	Int. B.C.	Est. B.C.	Francese
GAMME DE COULEURS	8x30	9.5x30	10x30	10x20	10x20	10x20	15x20	H: 15 cm	H: 15 cm	11x30	H: 11 cm	H: 11 cm	10x30
FARBEN PALETTE	pcs/box 30	pcs/box 30	pcs/box 30	pcs/box 25	pcs/box 25	pcs/box 25	pcs/box 24	pcs/box 4	pcs/box 4	pcs/box 30	pcs/box 4	pcs/box 4	pcs/box 30
GAMA DE COLORES													
BIANCO GHIACCIO	0080828	0084128	0090828	0080328	0083428	0080428	0082028	0082428	0082328	0081428	0082828	0082728	-
BIANCO	0080829	0084129	0090829	-	-	-	-	-	-	-	-	-	0081729
GRIGIO	0080813	0084113	-	-	-	-	-	-	-	-	-	-	-
NERO	0080811	004111	0090811	-	-	-	-	-	-	-	-	-	-

PEZZI SPECIALI / TRIM/FINISHES / FORMSTÜCKE / PIÈCES SPÉCIALES / PIEZAS ESPECIALES

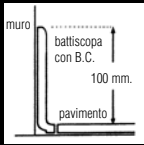

**ANGOLO INTERNO**  
INTERNAL ANGLE  
ANGLE INTERNE  
INNENECKE  
EXQUINA INTERIOR  
H:11 - 4<sup>1/2"</sup>  
H:15 - 6"

**SGUSCIA B.C.**  
COVE BASE  
PLINTE À GORGE  
HOHLKEHLENSOCKELLEISTE  
ZOCALO ESCOCIA  
11x30 - 4"x12"  
15x20 - 6"x8"

**UNGHIA**  
COMBINATION PIECE  
ONGLET RENTRANT  
INNENECKE ZUR RINNLEISTE  
ENCUENTRO ESCOCIA  
5x5 - 2"x2"

**RACCORDO**  
ANGLE BEAD  
CARREAU A CANIVEAU  
RINNLEISTE  
MEDIA CAÑA  
5x20 - 2"x8"  
R = 3 cm

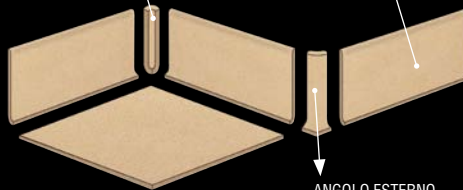

**ANGOLO ESTERNO**  
EXTERNAL ANGLE  
ANGLE EXTERIEUR  
AUSSENECKE  
EXQUINA EXTERIOR  
H:11 - 4<sup>1/2"</sup>  
H:15 - 6"

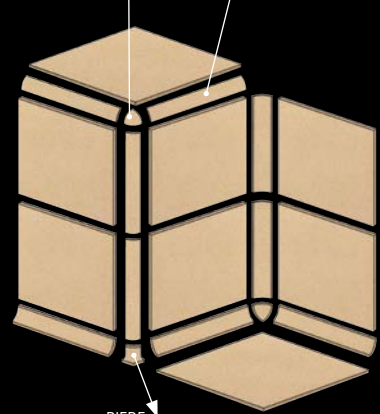

**PIEDE**  
STOP END  
COIN SORTANT  
USSENECKE ZUR  
RINNLEISTE  
PATA DE ELEFANTE  
5x5 - 2"x2"

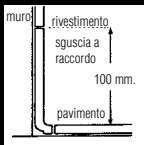

**ANGOLO INTERNO**  
INTERNAL ANGLE  
ANGLE INTERNE  
INNENECKE  
EXQUINA INTERIOR  
H:11 - 4<sup>1/2"</sup>

**SGUSCIA "FLAT TOP"**  
FLAT TOP COVE BASE  
PLINTE FLAT TOP  
FLAT TOP - HOHLKEHLENSOCKELLEISTE  
ZOCALO ESCOCIA FLAT TOP  
11x20 - 4<sup>1/2"</sup>x8"

**ANGOLO ESTERNO**  
EXTERNAL ANGLE  
ANGLE EXTERIEUR  
AUSSENECKE  
EXQUINA EXTERIOR  
H:11 - 4<sup>1/2"</sup>

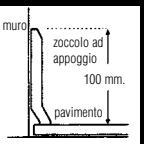
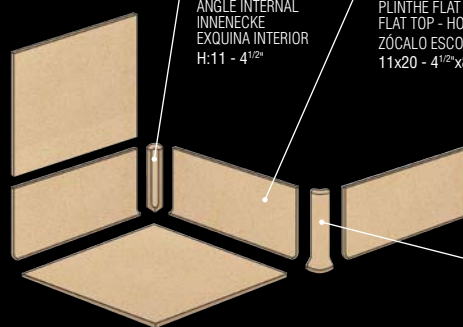

**ZOCOLO FRANCESE**  
COVE BASE BT.  
PLINTE À TALON BT.  
KEHLENSOCKEL BT.  
RODAPIES APOYADO BT.  
10x30 - 4"x12"

**BATTISCOPA B.C.**  
SKIRTING B.C.  
PLINTE B.C.  
SOCKELLEISTE B.C.  
RODAPIES B.C.  
8x30 - 3<sup>1/4"</sup>x12"  
9.30x30 - 3<sup>3/4"</sup>x12"  
10x30 - 4"x12"

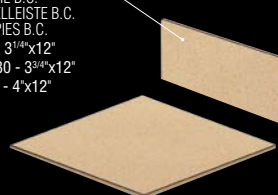
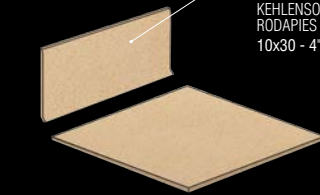

**BATTISCOPA B.C.**  
SKIRTING B.C.  
PLINTE B.C.  
SOCKELLEISTE B.C.  
RODAPIES B.C.  
10x20 - 4"x8"



**TERMINALE (SX)**  
EDGING PIECE (SX)  
ENDABDECKLEISTE (SX)  
ELEMENT FINAL (SX)  
TERMINAL (SX)  
10x20 - 4"x8"



**TERMINALE (DX)**  
EDGING PIECE (DX)  
ENDABDECKLEISTE (DX)  
ELEMENT FINAL (DX)  
TERMINAL (DX)  
10x20 - 4"x8"

# FACCIATE VENTILATE

Ventilated Façade / Hinterlüftete Fassaden / Façades Ventilées / Fachadas Ventiladas

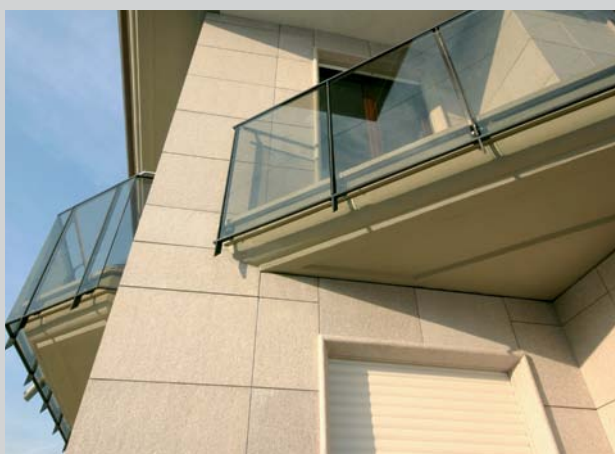
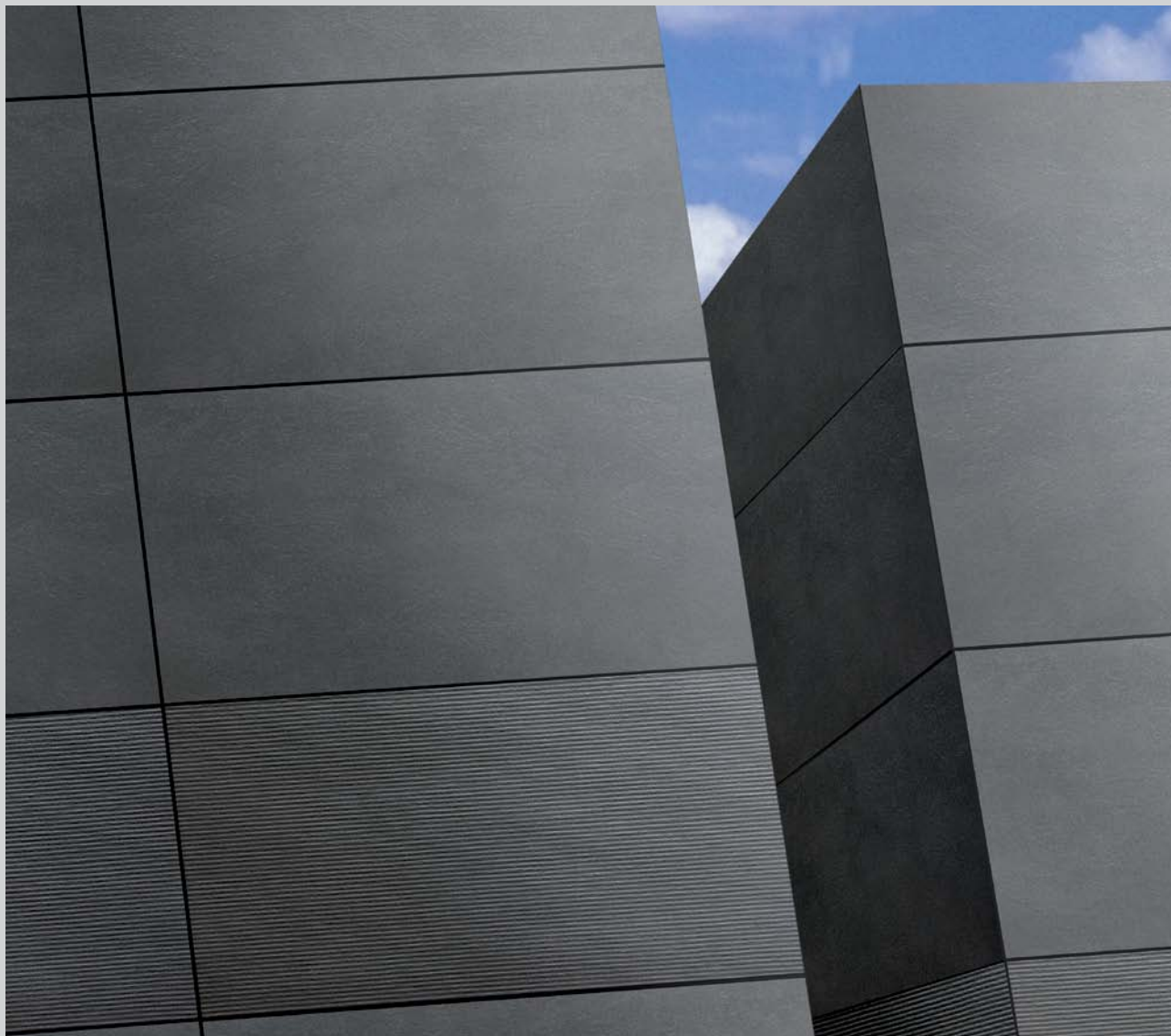

# IL NUOVO CONCETTO DI FACCIATA VENTILATA

## THE NEW CONCEPT OF VENTILATED FAÇADE / DAS NEUE KONZEPT DER HINTERLÜFTETEN FASSADE / LE NOUVEAU CONCEPT DE FAÇADE VENTILÉE / EL NUEVO CONCEPTO DE FACHADA VENTILADA

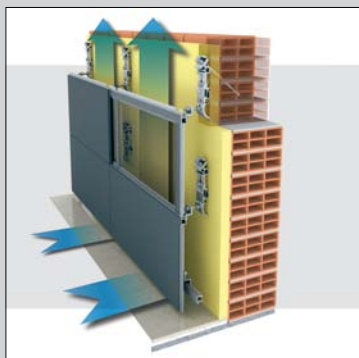

### Il Sistema

The System / Das System / Le Système / El Sistema

Cerdisa è stata una delle primissime aziende a produrre Gres Fine Porcellanato e a entrare a pieno titolo nel mondo dei grandi progetti. I prodotti Cerdisa sono sempre più legati all'evoluzione concettuale dell'abitare contemporaneo, che predilige funzionalità, versatilità, ma soprattutto design. Per questi motivi Cerdisa ha iniziato una collaborazione con GEOS ITALY, azienda all'avanguardia nella realizzazione di facciate ventilate che si distingue per gli elevati standard qualitativi raggiunti.

Cerdisa was one of the first companies to produce fine porcelain stoneware and enter the world of major design. The Cerdisa products have always been tied to the conceptual evolution of modern living, which favours functionality, versatility, and in particular design. In this regard Cerdisa began a collaboration with GEOS ITALY pioneer in the creation of façades ventilates that it is distinguished for the high standards achieved.

Cerdisa war eines der allerersten Unternehmen bei der Herstellung von Feinsteinzeug und beim vollberechtigten Einstieg in Großprojekte. Die Produkte des Hauses Cerdisa gehen immer enger mit dem fortschreitenden Konzept des zeitgenössischen Wohnens einher, das Funktionalität, Vielseitigkeit, aber vor allem Design schätzt. Aus diesen Gründen hat Cerdisa die Zusammenarbeit mit GEOS ITALY initiiert, einem Unternehmen, das bei der Ausführung hinterlüfteter Fassaden bahnbrechend ist und sich durch höchste Qualitätsstandards auszeichnet.

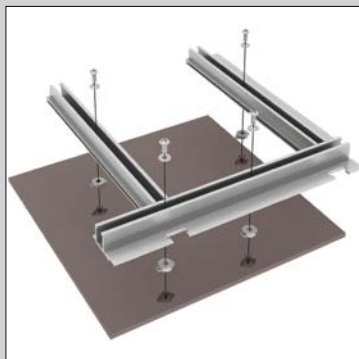

### L'ancoraggio alla lastra

Plate anchoring / Die Verankerung an der Platte  
L'ancrage sur la plaque / La fijación a la placa

Cerdisa a été une des toutes premières usines dans la fabrication du grès cérame pleine masse, et à rentrer de plein pied dans le monde des grands projets. Les produits Cerdisa sont de plus en plus liés à l'évolution conceptuelle de l'habitat contemporain, qui privilégie la fonctionnalité, la polyvalence, mais surtout le design. Pour toutes ces raisons, Cerdisa a démarré un rapport de partenariat avec GEOS ITALIE, une société pionnière dans la réalisation des façades ventilées qui se différencie grâce aux standards de qualité très élevée qu'elle vient d'atteindre.

Cerdisa fue una de las primeras empresas en dedicarse a la fabricación de Gres Fino Porcelánico y entrar de lleno en el mundo de los grandes proyectos. Los productos de Cerdisa están cada vez más estrechamente vinculados a la evolución conceptual del habitar contemporáneo, que prioriza la funcionalidad, la versatilidad y, sobre todo, el diseño. Por estas razones Cerdisa ha puesto en marcha una relación de colaboración con GEOS ITALY, empresa de vanguardia en la realización de fachadas ventiladas que se distingue por los elevados estándares cualitativos que garantiza.

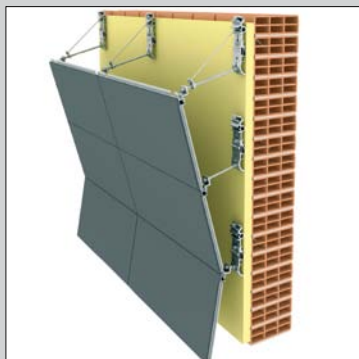

### Le regolazioni in opera su quattro assi principali

On-site adjustments to four main axes / Anpassung beim Verlegen entlang von vier Achsen / Réglages sur site selon quatre axes principaux / Regulaciones de instalación en los cuatro ejes principales

### • Estrema facilità, rapidità e precisione di installazione.

Extremely quick and easy precision installation. / Äußerst leichte, schnelle und präzise Installation. / Facilité, rapidité et précision d'installation extrêmes. / Extraordinaria facilidad, rapidez y precisión en la instalación.

### • Versatilità e adattabilità a lastre di finitura di qualsiasi formato.

Flexibility and adaptability to finishing slabs of any size. / Vielseitigkeit und einfaches Anpassen an Grundplatten jeder Größe. / Polyvalence et adaptabilité avec des plaques de finition dans tous les formats. / Versatilidad y adaptabilidad a placas de acabado de todos los formatos.

### • Minima dispersione e trasmittanza termica.

Minimal dispersion and thermal transmittance. / Äußerst geringer Wärmeverlust und geringe Wärmeübertragung. / Dispersion et transmission thermique minimales. / Dispersión y transmitancia térmica mínimas.

### • Massima sicurezza di ancoraggio con sistema "a scomparsa".

Secure anchorage thanks to the "Flush-Fit" system. / Höchste Verankerungssicherheit durch das „Versenk“-System. / Sécurité de fixation maximale avec un système « invisible ». / Máxima seguridad de fijación con sistema "empotrado".

### • Sistema innovativo riconosciuto e protetto da brevetto internazionale.

Innovative system covered by an international patent. / Ein innovatives, anerkanntes und international patentiertes System. / Système innovant reconnu et protégé par un brevet international. / Sistema innovador reconocido y protegido por una patente internacional.





The background of the page is an underwater scene with blue water and bubbles. Two light gray lines intersect diagonally, creating a white triangular area in the bottom right corner. The text 'POOL COLLECTION' is centered in this white area.

# POOL COLLECTION

# H<sub>2</sub>O LIFE PROJECT



**Bordo Wav.E Chalet Rovere Grip 30x80**  
**Griglia Steel-Gres Chalet Rovere Grip 20x80**  
**Chalet Rovere Grip 20x80**  
**Chalet Rovere Grip 13x80**



**Bordo Strip.E Archistone Grafite Grip 30x60**  
**Griglia Steel-Gres Archistone Grafite Grip 20x60**  
**Archistone Grafite Grip 60x60**



**Bordo 90° EC1 Bank SA Strutturato 30x60**  
**Griglia Steel-Gres EC1 Bank SA Strutturato 20x60**  
**EC1 Bank SA Strutturato 60x120**



**Bordo Round.E Neostone Avorio Grip 30x50**  
**Griglia Steel-Gres Neostone Avorio Grip 20x50**  
**Neostone Grigio Grip 50x100**

# H<sub>2</sub>O LIFE PROJECT

## Sistemi bordi piscina

Pool edges / Beckenrandfliesen / Bordures de piscine / Bordas de piscina

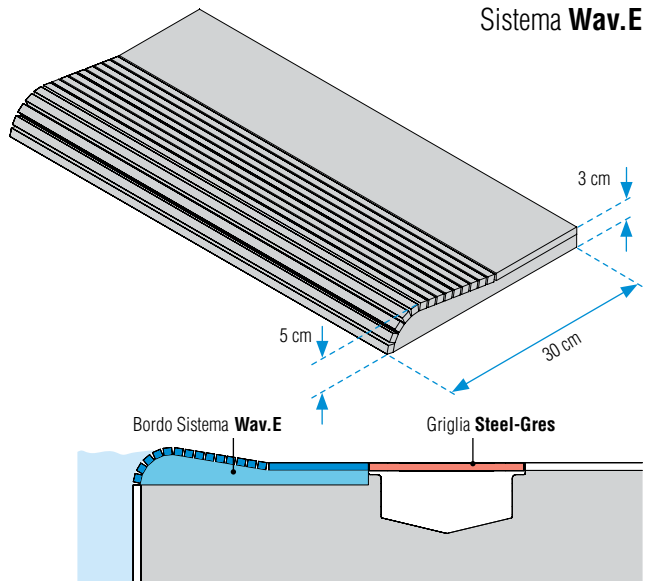

**Bordo a listelli pre-sagomato su supporto di cemento alleggerito**  
 Non-flexible strip edge tile on support made of lightened concrete / Randstein bestehend aus geschnittenen Streifen auf entlastet Zement / Bord à lattes préformé sur support en béton maigre / Borde con listones no flexible pre-soporte en cemento reducido

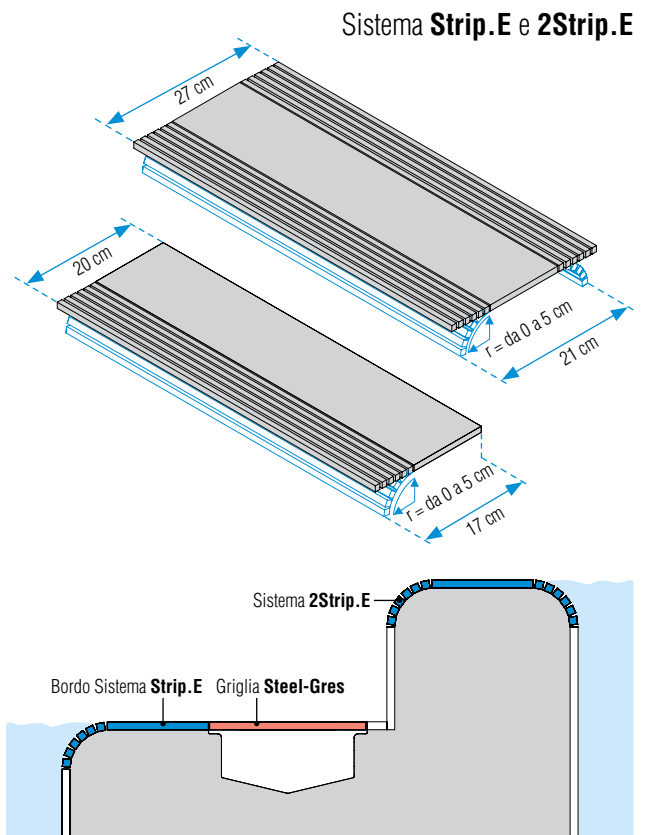

**Bordo e doppio bordo a listelli sagomabili su rete**  
 Flexible and double flexible strip edge tile on net / Netzverklebte Streifen für Randstein und Doppelrandstein / Bord et double bord à lattes flexibles sur filet / Borde y doble borde con listones flexible en la red

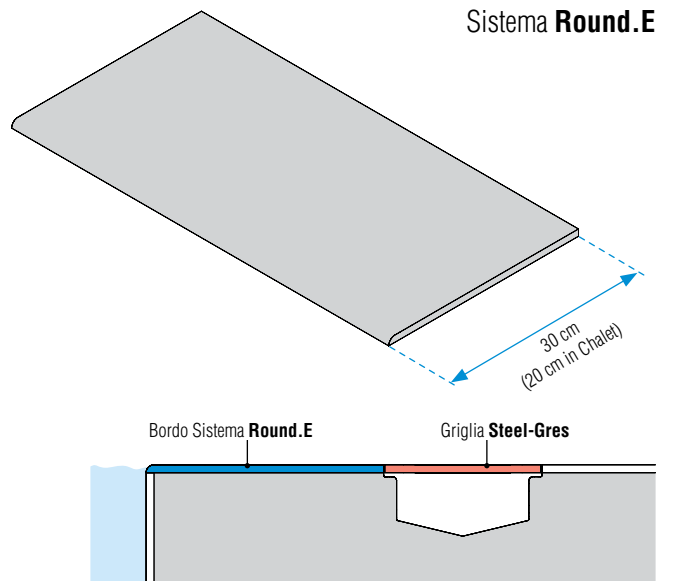

**Bordo a Becco di Civetta**  
Round Edge Tile / Abgerundeter Randstein / Bord arrondi / Borde redondeado

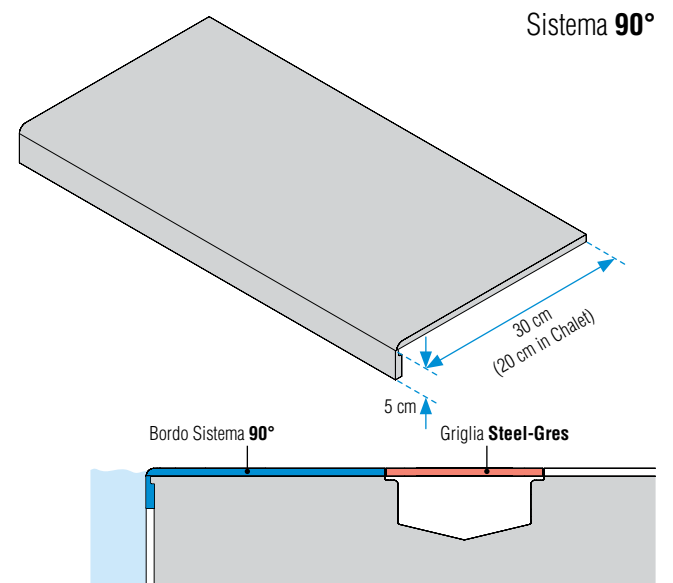

**Bordo a 90° con Becco Civetta**  
90° Straight Edge Tile / 90° Winkel Randstein / Bord 90° (avec retombée) / Borde a 90°

# H<sub>2</sub>O LIFE PROJECT

## Griglie e pezzi speciali

Grid and trims / Raster und Formteile / Grille et pièces spéciales / Rejilla y piezas especiales

### Griglia Steel-Gres

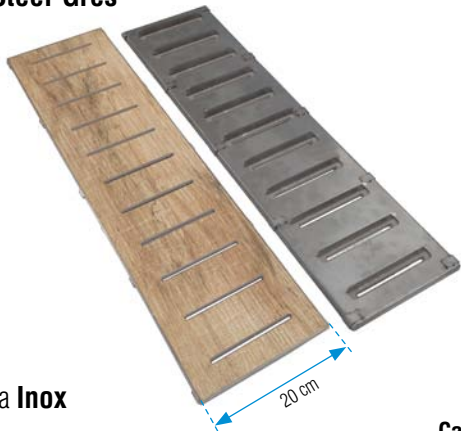

### Griglia lineare e angolo griglia con lastra in ceramica e custodia in acciaio AISI 316 lucidato resistente agli acidi

Straight grid and corner grid tile with ceramic slab and steel case AISI 316 smoothed and acid resilient  
Lineares Raster und Eckstück aus Keramik mit Halterung in Edelstahl AISI 316 säurebeständig  
Grille linéaire et angle grille avec dalle en grès et support en acier poli AISI 316 résistant aux acides  
Rejilla lineal y angular rejilla con plato de cerámica y cubierta en acero pulido caso AISI 316 resistente al ácido

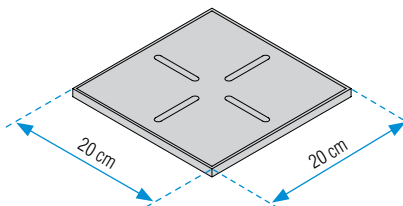

### Canaletta Inox

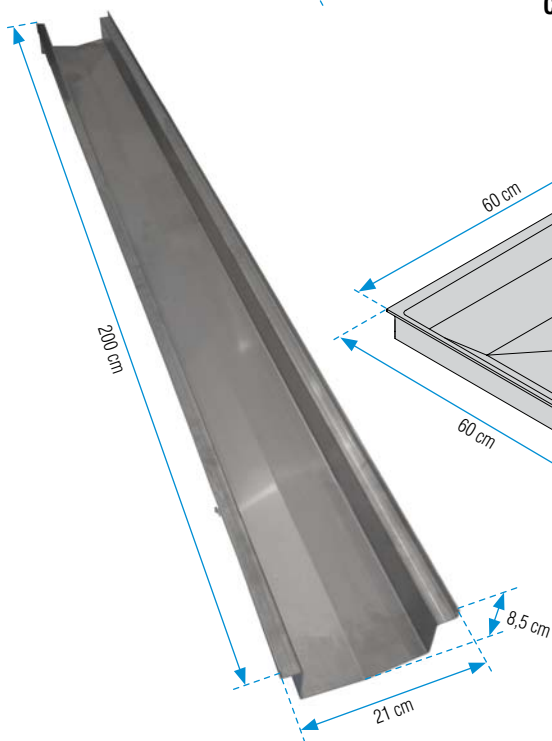

### Canaletta e flange di giunzioni in acciaio AISI 316 lucidato resistente agli acidi

Stainless steel AISI 316 gutter and flanges connection smoothed and acid resilient  
Rinne mit Befestigung in Edelstahl AISI 316 säurebeständig  
Caneau et bride de raccord en acier poli AISI 316 résistant aux acides  
Conducto bridas y juntas de acero AISI 316 pulido resistente a los ácidos

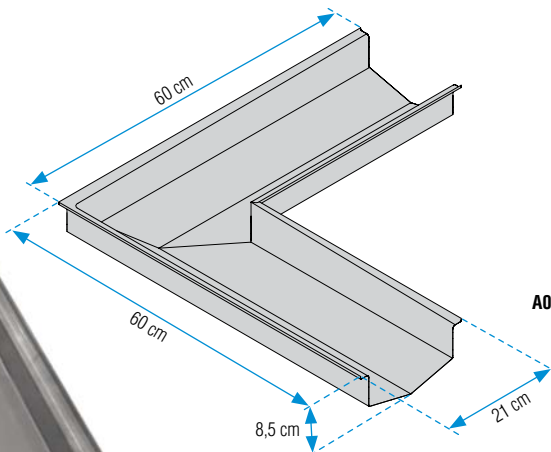

#### A003630 Canaletta Inox con foro e con flange di testa

Stainless steel gutter with hole and end flanges  
Edelstahlrinne mit Loch und Befestigungen  
Caneau inox avec trou et brides de tête  
Canal de acero con agujero y la brida de cabeza

#### A003631 Canaletta Inox senza foro e con flange di testa

Stainless steel gutter without hole and end flanges  
Edelstahlrinne ohne Loch und ohne Befestigung  
Caneau inox sans trou, avec brides de tête  
Canal de acero sin orificio y la brida de cabeza

#### A003632 Canaletta Inox senza foro con una flangia di testa

Stainless steel gutter without hole and with one end flange  
Edelstahlrinne mit Loch und Befestigung  
Caneau inox sans trou, avec un bride de tête  
Canal de acero sin agujero con una cabeza de brida

#### A003633 Angolo canaletta Inox

Stainless steel gutter corner  
Edelstahlrinnecke  
Angle canneau inox  
Ángulo de acero del canal

#### A003634 Flangia di giunzione in Inox

Stainless steel connection flange  
Befestigung in Edelstahl  
Bride de raccord inox  
Juntas de bridas de acero



## Sistema di raccolta acqua

Water collection system / Wassersammelsystem / Système de recolté eau / Sistema de recogida agua

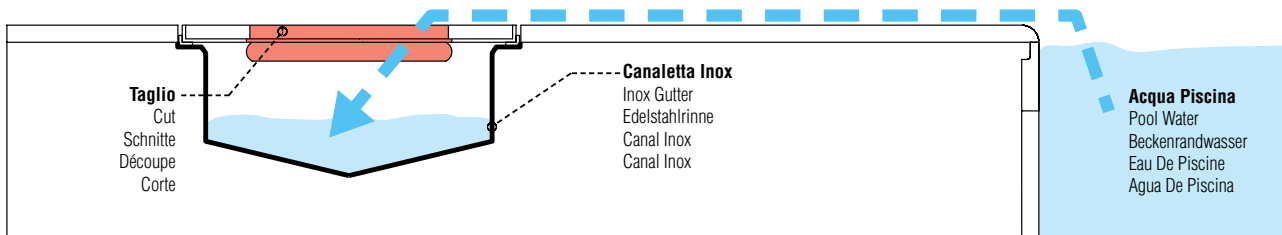

### L'acqua entra nella Canaletta Inox attraverso i tagli della Griglia Steel-Gres

Water enters the Inox Gutter through the cuts of the Steel-Gres grid / Das Wasser fließt in die Edelstahlrinne durch das Raster im Steel-Gres hinein / L'eau pénètre dans le Caniveau Inox à travers les découpes de la grille Steel-Gres / El agua entra en el Canal Inox por los cortes de la rejilla Steel-Gres

**Griglia Double-Gres**

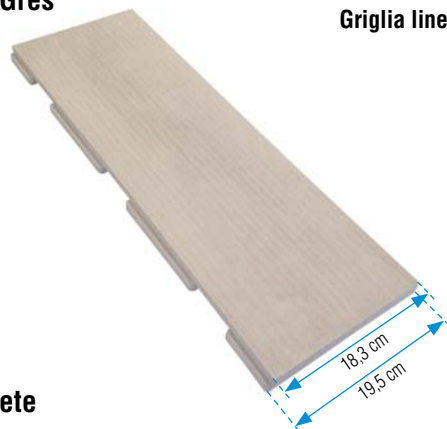

**Griglia lineare e angolo griglia con due lastre in ceramica incollate sovrapposte**

Straight grid and corner grid tile with two ceramic slabs pasted each-other  
Lineares Raster und Eckstück aus Keramik mit Keramikstegen  
Grille linéaire et angle grille avec deux dalles en grès collées superposées  
Rejilla lineal y angular rejilla con dos placas de cerámica unidas superpuestas

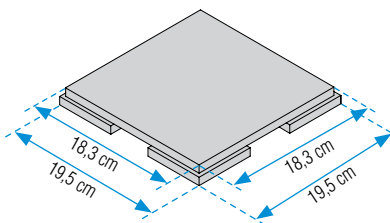

**Canaletta Concrete**

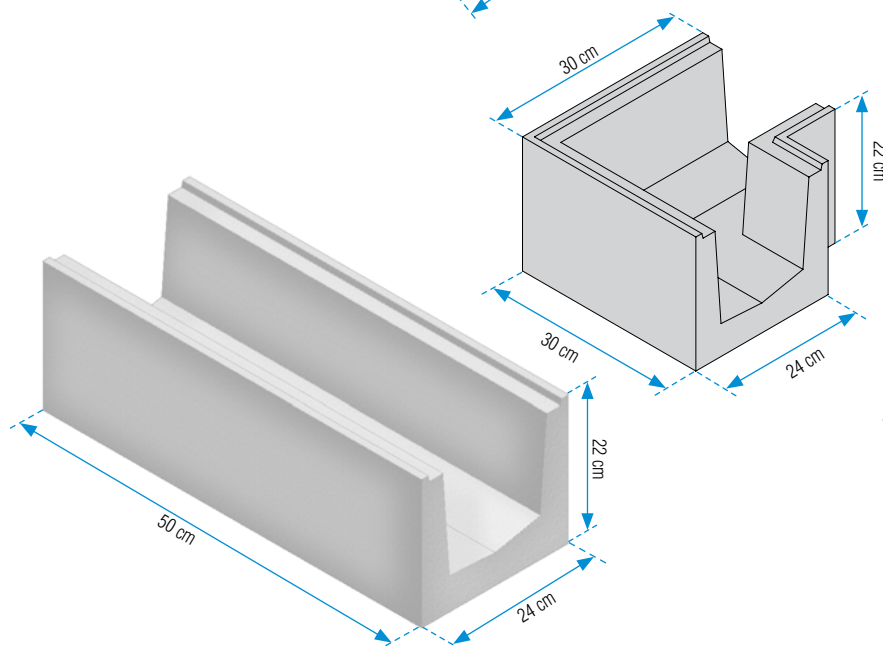

**Canala di sfioro in pietra ricostruita**

Spillway gutter made of reconstructed stone  
Gussbetonrinne  
Goulotte de débordement en pierre reconstituée  
Canal de desbordamiento en piedra reconstruida

**A004030 Canala di sfioro in pietra ricostruita**

Spillway gutter made of reconstructed stone  
Gussbetonrinne  
Goulotte de débordement en pierre reconstituée  
Canal de desbordamiento en piedra reconstruida

**A004031 Angolo canala di sfioro in pietra ricostruita**

Spillway gutter corner made of reconstructed stone  
Gussbetonrinnenecke  
Angle goulotte de débordement en pierre reconstituée  
Angulo de canal de desbordamiento en piedra reconstruida

**A004032 Canala di sfioro in pietra ricostruita con foro**

Spillway gutter made of reconstructed stone with hole  
Gussbetonrinne mit Loch  
Goulotte de débordement en pierre reconstituée avec trou  
Canal de desbordamiento en pietra ricostruita con agujero

**Sistema di raccolta acqua**

Water collection system / Wassersammelsystem / Système de recolté eau / Sistema de recogida agua

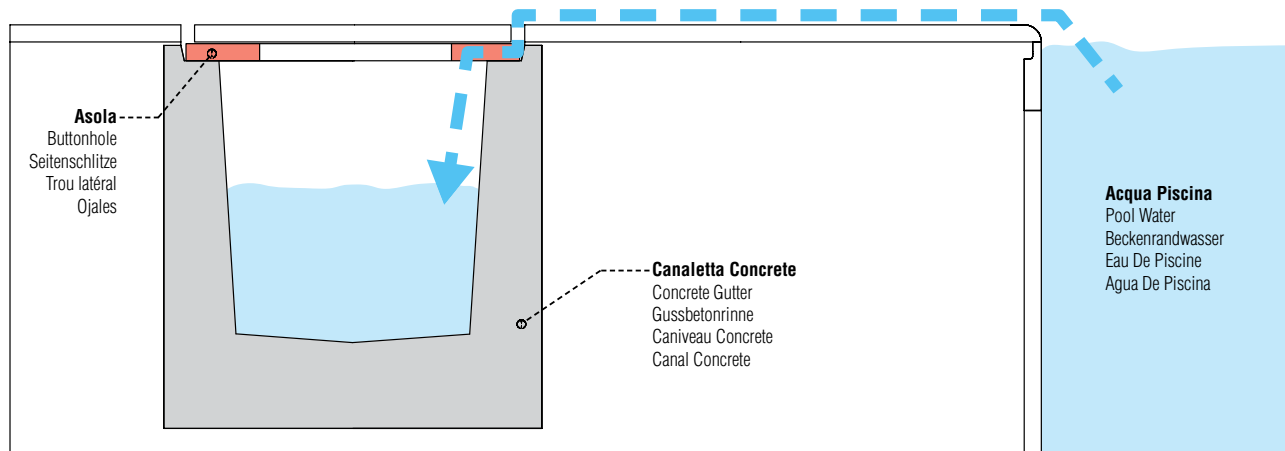

**L'acqua entra nella Canaletta Concrete attraverso le asole della Griglia Double-Gres**

Water enters the Concrete gutter through the buttonholes of the Double-Gres grid / Das Wasser fließt in die Gussbetonrinne durch die Seitenschlitze des Double-Gres Raster / L'eau pénètre dans le Caniveau Concrete à travers les trou latéral de la grille Double-Gres / El agua entra en el Canal Concrete por los ojales de la rejilla Double-Gres



# H<sub>2</sub>O LIFE PROJECT

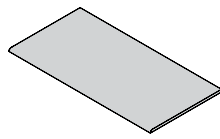

Round.E

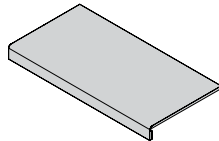

90°

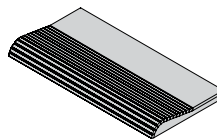

Wav.E

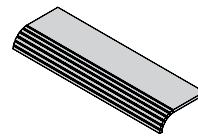

Strip.E

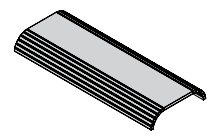

2Strip.E

## ARCHISTONE GRIP / GRIP SURFACE / SURFACE GRIP / GRIFFIGE OBERFLÄCHE / SUPERFICIE ANTIDESLIZANTE

	30x60 - 12"x24"	30x60 - 12"x24"	30x60 - 12"x24"	20x60 - 8"x24"	27x60 - 10 <sup>7/8</sup> "x24"
Grafite	0003552	0003568	0003627	0003595	0003611
Limestone Bianco	0003553	0003569	0003628	0003596	0003612
Limestone Crema	0003554	0003570	0003629	0003597	0003613

## CHALET GRIP / GRIP SURFACE / SURFACE GRIP / GRIFFIGE OBERFLÄCHE / SUPERFICIE ANTIDESLIZANTE

	20x80 - 8"x32"	20x80 - 8"x32"	30x80 - 12"x32"	20x80 - 8"x32"	27x80 - 10 <sup>7/8</sup> "x32"
Rovere	0003550	0003562	0003621	0003589	0003605
Ciliegio	0003551	0003563	0003622	0003590	0003606
Bianco	0003549	0003561	0003620	0003588	0003604
Nero	0003500	0003564	0003623	0003591	0003607

## EC1 STRUTTURATO / TEXTURED / STRUKTURIERTE / STRUCTURÉE / ESTRUCTURADO

	30x60 - 12"x24"	30x60 - 12"x24"	30x60 - 12"x24"	20x60 - 8"x24"	27x60 - 10 <sup>7/8</sup> "x24"
Farringdon BI	0003543	0003555	0003614	0003571	0003598
City AN	0003547	0003559	0003618	0003512	0003602
Barbican NE	0003548	0003560	0003619	0003513	0003603
Bank SA	0003544	0003556	0003615	0003509	0003599
Holborn TA	0003545	0003557	0003616	0003510	0003600
Docks FA	0003546	0003558	0003617	0003511	0003601

## NEOSTONE GRIP / GRIP SURFACE / SURFACE GRIP / GRIFFIGE OBERFLÄCHE / SUPERFICIE ANTIDESLIZANTE

	30x50 - 12"x20"	33x50 - 13"x20"	30x50 - 12"x20"	20x50 - 8"x20"	27x50 - 10 <sup>7/8</sup> "x20"
Avorio	0003501	0003565	0003624	0003592	0003608
Grigio	0003502	0003566	0003625	0003593	0003609
Antracite	0003503	0003567	0003626	0003594	0003610

	<b>Pezzi/Sc.</b> Pcs/Box / Pcs/Ctn Stck/Kart / Piezas/Caja	<b>Mq/Sc</b> Sq.M/Box / Mq/Ctn Qm/Kart / Mq/Caja	<b>Kg/Sc</b> Kg/Box / Kg/Ctn Kg/Kart / Kg/Caja	<b>Pezzi/Sc.</b> Pcs/Box / Pcs/Ctn Stck/Kart / Piezas/Caja	<b>Mq/Sc</b> Sq.M/Box / Mq/Ctn Qm/Kart / Mq/Caja	<b>Kg/Sc</b> Kg/Box / Kg/Ctn Kg/Kart / Kg/Caja
--	--	--	--	--	--	--

### ARCHISTONE

Round.E	6	1,08	25,5
90°	4	0,72	17
Wav.E	1	0,18	14,5
Strip.E	4	0,48	16,5
2Strip.E	4	0,64	18

### CHALET

Round.E	6	0,96	15,6
90°	2	0,32	5,2
Wav.E	1	0,24	18,2
Strip.E	4	0,64	9,6
2Strip.E	4	0,86	12

### EC1

Round.E	6	1,08	27
90°	4	0,72	18
Wav.E	1	0,18	14,5
Strip.E	4	0,48	16,5
2Strip.E	4	0,64	18

### NEOSTONE

Round.E	6	0,9	22,5
90°	4	0,6	15
Wav.E	1	0,15	11,8
Strip.E	4	0,4	14,6
2Strip.E	4	0,54	16

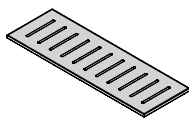

Griglia Steel-Gres



Angolo Steel-Gres

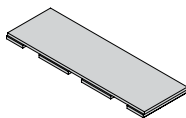

Griglia Double-Gres

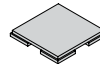

Angolo Double-Gres

**ARCHISTONE GRIP** / GRIP SURFACE / SURFACE GRIP / GRIFFIGE OBERFLÄCHE / SUPERFICIE ANTIDESLIZANTE

	20x60 - 8"x24"	20x20 - 8"x8"	20x60 - 8"x24"	20x20 - 8"x8"
Grafite	0003648	0003664	0003680	0003696
Limestone Bianco	0003649	0003665	0003681	0003697
Limestone Crema	0003650	0003666	0003682	0003698

**CHALET GRIP** / GRIP SURFACE / SURFACE GRIP / GRIFFIGE OBERFLÄCHE / SUPERFICIE ANTIDESLIZANTE

	20x80 - 8"x32"	20x20 - 8"x8"	20x80 - 8"x32"	20x20 - 8"x8"
Rovere	0003642	0003658	0003674	0003690
Ciliegio	0003643	0003659	0003675	0003691
Bianco	0003641	0003657	0003673	0003689
Nero	0003644	0003660	0003676	0003692

**EC1 STRUTTURATO** / TEXTURED / STRUKTURIERTE / STRUCTURÉE / ESTRUCTURADO

	20x60 - 8"x24"	20x20 - 8"x8"	20x60 - 8"x24"	20x20 - 8"x8"
Farringdon Bl	0003635	0003651	0003667	0003683
City AN	0003639	0003655	0003671	0003687
Barbican NE	0003640	0003656	0003672	0003688
Bank Sa	0003636	0003652	0003668	0003684
Holborn Ta	0003637	0003653	0003669	0003685
Docks Fa	0003638	0003654	0003670	0003686

**NEOSTONE GRIP** / GRIP SURFACE / SURFACE GRIP / GRIFFIGE OBERFLÄCHE / SUPERFICIE ANTIDESLIZANTE

	20x50 - 8"x20"	20x20 - 8"x8"	20x50 - 8"x20"	20x20 - 8"x8"
Avorio	0003645	0003661	0003677	0003693
Grigio	0003646	0003662	0003678	0003694
Antracite	0003647	0003663	0003679	0003695

	<b>Pezzi/Sc.</b> Pcs/Box / Pcs/Ctn Stck/Kart / Piezas/Caja	<b>Mq/Sc</b> Sq.M/Box / Mq/Ctn Qm/Kart / Mq/Caja	<b>Kg/Sc</b> Kg/Box / Kg/Ctn Kg/Kart / Kg/Caja		<b>Pezzi/Sc.</b> Pcs/Box / Pcs/Ctn Stck/Kart / Piezas/Caja	<b>Mq/Sc</b> Sq.M/Box / Mq/Ctn Qm/Kart / Mq/Caja	<b>Kg/Sc</b> Kg/Box / Kg/Ctn Kg/Kart / Kg/Caja
<b>ARCHISTONE</b>				<b>EC1</b>			
Steel-Gres	1	0,12	4,2	Steel-Gres	1	0,12	4,4
Ang. Steel-Gres	1	0,04	1,4	Ang. Steel-Gres	1	0,04	1,4
Double-Gres	1	0,12	6,8	Double-Gres	1	0,12	7,2
Ang. Double-Gres	1	0,04	2,2	Ang. Double-Gres	1	0,04	2,2
<b>CHALET</b>				<b>NEOSTONE</b>			
Steel-Gres	1	0,16	5,2	Steel-Gres	1	0,1	3,7
Ang. Steel-Gres	1	0,04	1,4	Ang. Steel-Gres	1	0,04	1,4
Double-Gres	1	0,16	8,2	Double-Gres	1	0,1	6,1
Ang. Double-Gres	1	0,04	2,2	Ang. Double-Gres	1	0,04	2,2

# H<sub>2</sub>O SPORT PROJECT

**Gres porcellanato smaltato EN 14411 Bla**

Glazed porcelain stoneware / Glasiertes Feinsteinzeug / Grès cérame émaillé / Gres porcelánico esmaltado

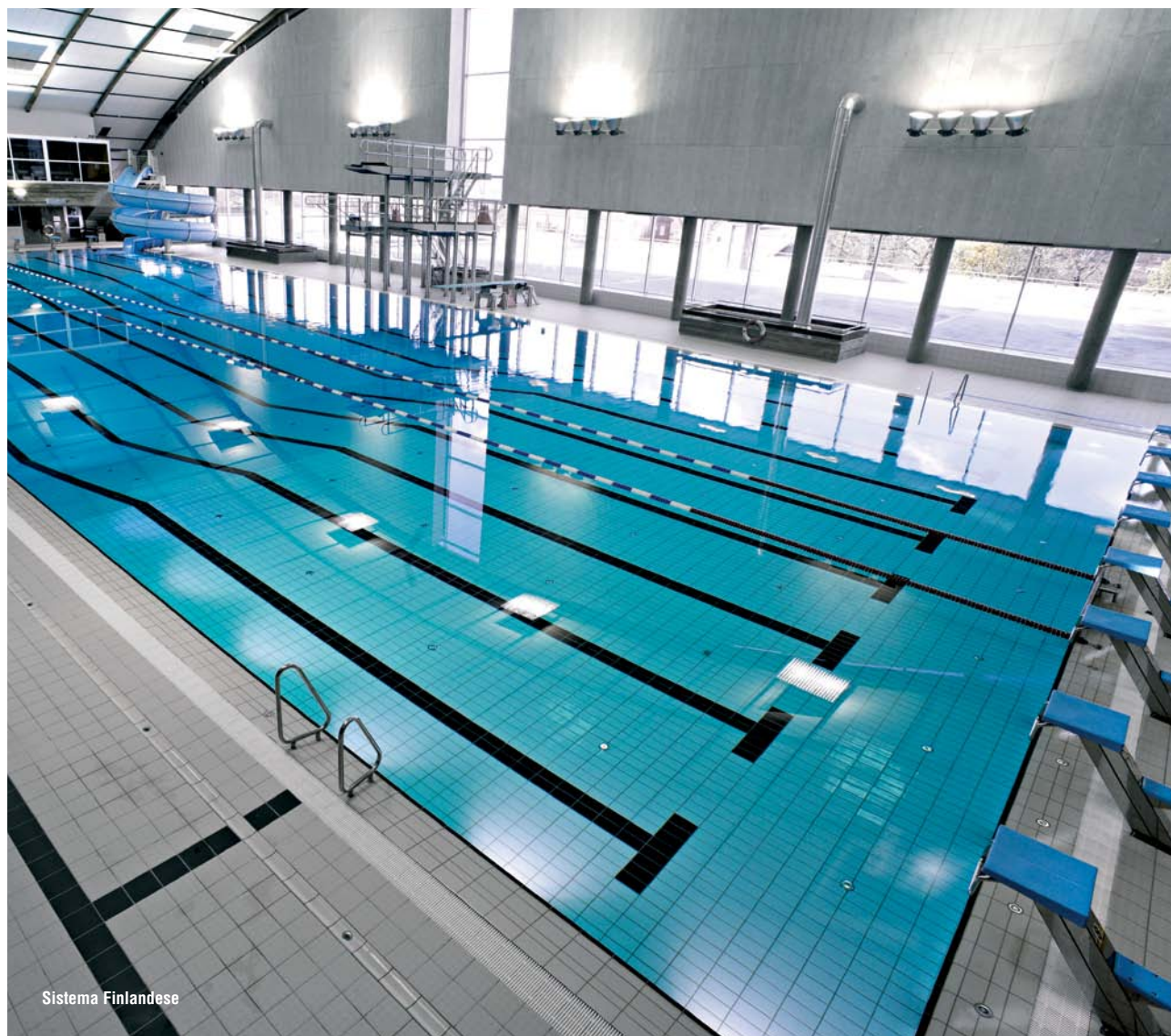

Sistema Finlandese



Bianco Nat. Matt 12,5x25  
Azzurro Caraibico Nat. Matt 12,5x25  
Sguscia esterna Bianco 3x25

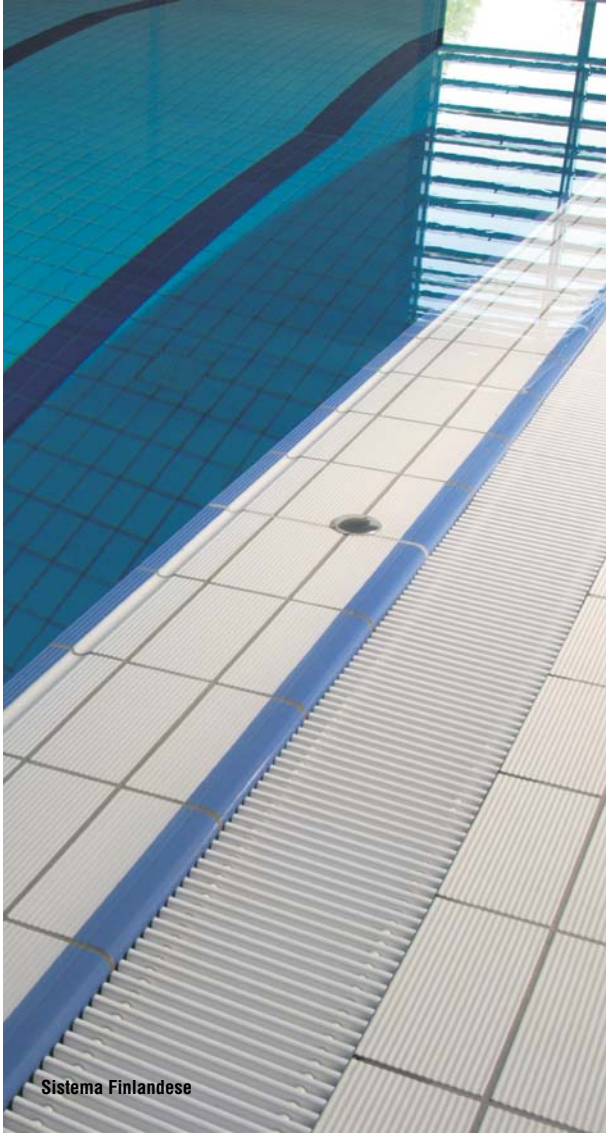

Sistema Finlandese



Bianco Nat. Matt 12,5x25  
Nero Nat. Matt 12,5x25

**Formati** / Sizes / Grösse / Format / Tamaño:



12,5x25  
5"x10"

**Superfici** / Surface / Oberfläche / Surface / Superficie

**NATURALI MATT** / NATURAL MATT / NATUR MATT / NATURELLE MAT / NATURAL MATE

**ANTISCIVOLO B MATT** / SLIP RESISTANT / TRITTSICHER OBERFLÄCHE  
ANTIDERAPANTE / ANTIDESLIZANTE

**ANTISCIVOLO C MATT** / SLIP RESISTANT / TRITTSICHER OBERFLÄCHE  
ANTIDERAPANTE / ANTIDESLIZANTE

**BRILLANTI** / GLOSS / GLÄNZEND / BRILLANT / BRILLO

# H<sub>2</sub>O SPORT PROJECT

## Gres porcellanato smaltato EN 14411 Bia

Glazed porcelain stoneware / Glasiertes Feinsteinzeug / Grès cérame émaillé / Gres porcelánico esmaltado



A Matt > 0,60 dry / < 0,50 wet  
B Matt > 0,60 dry / > 0,60 wet

C Matt > 0,60 dry / > 0,60 wet  
Brillanti > 0,60 dry / < 0,50 wet

ANSI A 137.1:2012  
B Matt  
DCOF ≥ 0,42



ANSI A 137.1:2012  
C Matt  
DCOF ≥ 0,42



### COLORI / COLOURS / FARBEN / COULEURS / COLORES

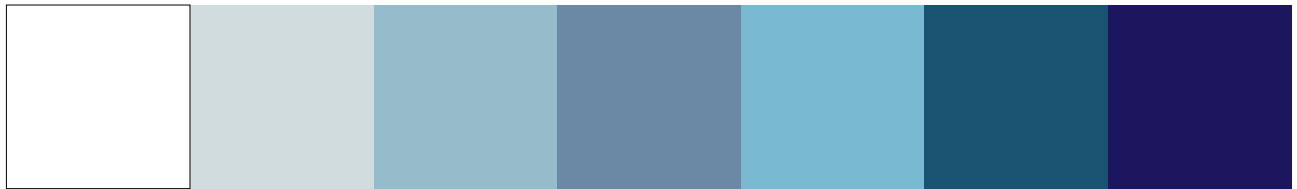

Bianco

Azzurro  
Ghiaccio

Azzurro  
Celeste

Azzurro  
Atlante

Azzurro  
Caraibico

Azzurro  
Petrolio

Blu Cobalto

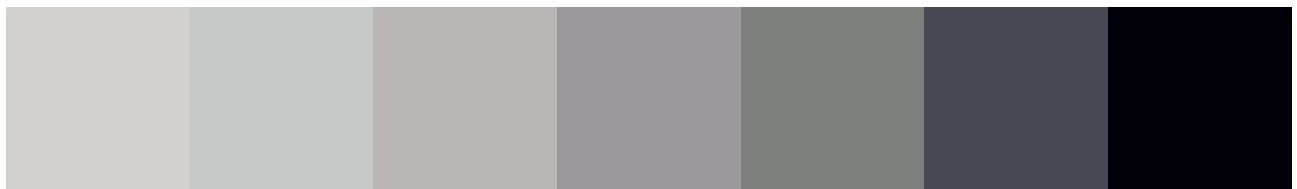

Grigio Perla

Grigio Argento

Grigio Acciaio

Grigio Piombo

Grigio Profondo

Grigio Antracite

Nero

COLORI COLORS COULEURS FARBEN COLORES	 B ≥ 18°		 C ≥ 24°		 BECCO CIVETTA lato corto 12,5x25 5'x10'		 BECCO CIVETTA lato lungo 12,5x25 5'x10'		 BECCO CIVETTA ang. destro 12,5x25 5'x10'		 BECCO CIVETTA ang. sinistro 12,5x25 5'x10'		 B.C. B MATT lato corto 12,5x25 5'x10'		 B.C. B MATT lato lungo 12,5x25 5'x10'		 B.C. B MATT ang. destro 12,5x25 5'x10'		 B.C. B MATT ang. sinistro 12,5x25 5'x10'	
	NATURALE MATT 12,5x25 5'x10'	ANTISCIVOLO B MATT 12,5x25 5'x10'	ANTISCIVOLO C MATT 12,5x25 5'x10'	BRILLANTE 12,5x25 5'x10'	BECCO CIVETTA lato corto 12,5x25 5'x10'	BECCO CIVETTA lato lungo 12,5x25 5'x10'	BECCO CIVETTA ang. destro 12,5x25 5'x10'	BECCO CIVETTA ang. sinistro 12,5x25 5'x10'	B.C. B MATT lato corto 12,5x25 5'x10'	B.C. B MATT lato lungo 12,5x25 5'x10'	B.C. B MATT ang. destro 12,5x25 5'x10'	B.C. B MATT ang. sinistro 12,5x25 5'x10'								
BIANCO	0003322	0003333	0003339	003325	0003366	0003398	0003430	0003462	0003373	0003405	0003437	0003469								
AZZ. GHIACCIO	0003313	-	-	-	0003357	0003389	0003421	0003453	-	-	-	-								
AZZ. CELESTE	0003314	-	-	-	0003358	0003390	0003422	0003454	-	-	-	-								
AZZ. ATLANTE	0003315	-	-	-	0003359	0003391	0003423	0003455	-	-	-	-								
AZZ. CARAIBICO	0003316	0003330	0003337	0003326	0003360	0003392	0003424	0003456	-	-	-	-								
AZZ. PETROLIO	0003317	-	-	-	0003361	0003393	0003425	0003457	-	-	-	-								
BLU COBALTO	0003323	0003334	0003340	0003328	0003367	0003399	0003431	0003463	0003374	0003406	0003438	0003470								
GRIGIO PERLA	0003300	-	-	-	0003344	0003376	0003408	0003440	-	-	-	-								
GRIGIO ARGENTO	0003301	-	-	-	0003345	0003377	0003409	0003441	-	-	-	-								
GRIGIO ACCIAIO	0003302	-	-	-	0003346	0003378	0003410	0003442	-	-	-	-								
GRIGIO PIOMBO	0003303	-	-	-	0003347	0003379	0003411	0003443	-	-	-	-								
GRIGIO PROFONDO	0003304	-	-	-	0003348	0003380	0003412	0003444	-	-	-	-								
GRIGIO ANTRACITE	0003305	-	-	-	0003349	0003381	0003413	0003445	-	-	-	-								
NERO	0003324	0003335	-	0003327	0003368	0003400	0003432	0003464	0003375	0003407	0003439	0003471								
GELSOMINO	0003306	0003329	0003336	-	0003350	0003382	0003414	0003446	0003369	0003401	0003433	0003465								
SABBIA	0003308	-	-	-	0003352	0003384	0003416	0003448	-	-	-	-								
BEIGE	0003309	-	-	-	0003353	0003385	0003417	0003449	-	-	-	-								
BEIGE KALAHARI	0003311	-	-	-	0003355	0003387	0003419	0003451	-	-	-	-								
BEIGE BAHAMAS	0003310	-	-	-	0003354	0003386	0003418	0003450	-	-	-	-								
MANDARINO	0003307	-	-	-	0003351	0003383	0003415	0003447	-	-	-	-								
COGNAC	0003312	-	-	-	0003356	0003388	0003420	0003452	-	-	-	-								
VERDE MENTA	0003318	-	-	-	0003362	0003394	0003426	0003458	-	-	-	-								
VERDE ACQUA	0003320	0003331	0003338	-	0003364	0003396	0003428	0003460	0003371	0003403	0003435	0003467								
VERDE MARE	0003321	0003332	-	-	0003365	0003397	0003429	0003461	0003372	0003404	0003436	0003468								
VERDE VITTORIANO	0003319	-	-	-	0003363	0003395	0003427	0003459	-	-	-	-								

### Imballi / Packing / Verpackungen / Embalajes / Embalajes

Formato	Pezzi/Sc.	Mq/Sc	Sc/Pal	Mq/Pal	Kg/Sc	Kg/Pal
Size	Pcs/Box	Sq.M/Box	Box/Pal	Sq.M/Pal	Kg/Box	Kg/Pal
Größe	Pcs/Ctn	Mq/Ctn	Ctn/Pal	Mq/Pal	Kg/Ctn	Kg/Pal
Format	Stck/Kart	Qm/Kart	Kart/Pal	Qm/Pal	Kg/Kart	Kg/Pal
Tamaño	Piezas/Caja	Mq/Caja	Caja/Pal	Mq/Pal	Kg/Caja	Kg/Pal
12,5x25	32	1	81	81	14,80	1224



Gelsomino

Sabbia

Beige

Beige Kalahari

Beige Bahamas

Mandarino

Cognac

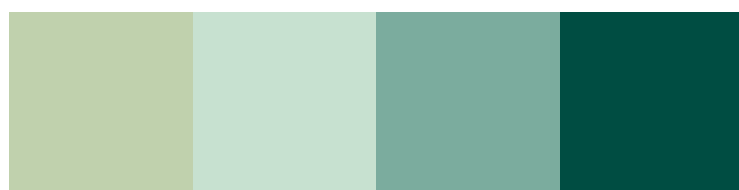



Verde Menta

Verde Acqua

Verde Mare

Verde Vittoriano

COLORI COLORS COULEURS FARBEN COLORES						
	SGUSCIA INTERNA 3x25 1 <sup>15</sup> °x10°	SGUSCIA ESTERNA 3x25 1 <sup>15</sup> °x10°	SGUSCIA INTERNA ang. alto 7x3 24 <sup>5</sup> °x1 <sup>15</sup> °	SGUSCIA INTERNA ang. basso 3x3 1 <sup>15</sup> °x1 <sup>15</sup> °	SGUSCIA ESTERNA ang. alto 3,7x3,7 1 <sup>15</sup> °x1 <sup>15</sup> °	SGUSCIA ESTERNA ang. basso 7x3 24 <sup>5</sup> °x1 <sup>15</sup> °
BIANCO	0003472	0003475	0003478	0003484	0003487	0003481
AZZ. GHIACCIO	-	-	-	-	-	-
AZZ. CELESTE	-	-	-	-	-	-
AZZ. ATLANTE	-	-	-	-	-	-
AZZ. CARAIBICO	0003473	0003476	0003479	0003485	0003488	0003482
AZZ. PETROLIO	-	-	-	-	-	-
BLU COBALTO	-	-	-	-	-	-
GRIGIO PERLA	-	-	-	-	-	-
GRIGIO ACCIAIO	-	-	-	-	-	-
GRIGIO ARGENTO	-	-	-	-	-	-
GRIGIO PIOMBO	-	-	-	-	-	-
GRIGIO PROFONDO	-	-	-	-	-	-
GRIGIO ANTRACITE	-	-	-	-	-	-
NERO	-	-	-	-	-	-
GELSOMINO	-	-	-	-	-	-
SABBIA	-	-	-	-	-	-
BEIGE	-	-	-	-	-	-
BEIGE KALAHARI	-	-	-	-	-	-
BEIGE BAHAMAS	-	-	-	-	-	-
MANDARINO	-	-	-	-	-	-
COGNAC	-	-	-	-	-	-
VERDE MENTA	-	-	-	-	-	-
VERDE ACQUA	-	-	-	-	-	-
VERDE MARE	-	-	-	-	-	-
VERDEVITTORIANO	-	-	-	-	-	-

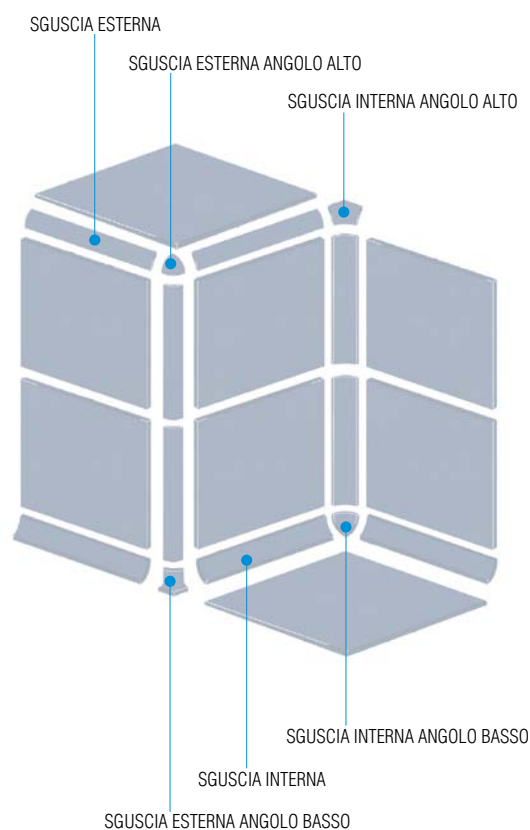

**La superficie di vendita M12,5x25 cm è calcolata sulla base della dimensione convenzionale, uguale alla dimensione nominale più una fuga di 5 mm.**

Sales area 5"x9<sup>7/8</sup>" calculated on the basis of the standard size, equal to the nominal size plus a 5 mm joint / Verkaufsoberfläche M12,5x25 cm unter der Grundlage konventioneller Abmessungen gleich der Nennabmessungen plus einer Fuge von 5 mm / Surface de vente M12,5x25 cm calculées sur la base de la dimension conventionnelle, égale à la dimension nominale plus joint de 5 mm / La superficie de venta M12,5x25 cm se calcula sobre la base de tamaño convencional, igual al tamaño nominal más una distancia de separación de 5 mm.

# H<sub>2</sub>O SPORT PROJECT

## Pezzi speciali

Special trims / Sonderstücke / Pieces especiales / Piezas especiales

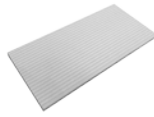

**BORDO VASCA  
RIGATO**  
M12,5x25  
5"x10"

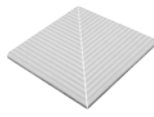

**ANG. B. VASCA  
RIGATO**  
M12,5x12,5  
5"x5"

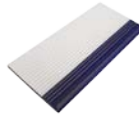

**BORDO VASCA  
RIGATO  
CON B. C. BLU  
SMALTATO**  
M12,5x25  
5"x10"

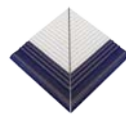

**ANG. ESTERNO B. VASCA  
RIGATO  
CON B. C. BLU  
SMALTATO**  
M12,5x12,5  
5"x5"

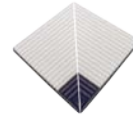

**ANG. INTERNO B. VASCA  
RIGATO  
CON B. C. BLU  
SMALTATO**  
M12,5x12,5  
5"x5"

CODICE	0003538	0003539	0003540	0003541	0003542
SPESSORE	7,8	7,8	7,8	7,8	7,8

## Il bordo blu cobalto è smaltato

The cobalt edge is glazed  
Kobaltblau Beckenrand ist glasiert  
Le bord de piscine cobalt est émaillé  
El bordo de piscina cobalto está esmaltado

## IMBALLI

PACKING / VERPACKUNGEN / EMBALLAGES / EMBALAJES

FORMATO	12,5x25	12,5x12,5	12,5x25	12,5x12,5	12,5x12,5
PEZZI-SCATOLA	32	1	32	1	1
MQ-SC	1	0,03	1	0,03	0,03
SC-PAL	105	-	105	-	-
MQ-PAL	105	-	105	-	-
KG-SC	12,19	1,6	12,19	1,6	1,6
KG-PAL	1279,95	-	1279,95	-	-



**CANALE INTERNO DI  
RICICLO - 90°**  
M12,5x25  
5"x10"



**CANALE INTERNO DI  
RICICLO - 107°**  
M12,5x25  
5"x10"



**CANALE DI RACCOLTA**  
M12,5x25  
5"x10"



**CANALE DI RACCOLTA E  
SCARICO**  
M12,5x25  
5"x10"



**CANALE DI RACCOLTA  
TERMINALE**  
M12,5x25  
5"x10"



**CANALE DI RACCOLTA  
ANGOLARE**  
M12,5x12,5  
5"x5"

CODICE	0003518	0003519	0003514	0003515	0003516	0003517
SPESSORE	15	15	20	20	20	20

## IMBALLI

PACKING / VERPACKUNGEN / EMBALLAGES / EMBALAJES

FORMATO	12,5x25	12,5x25	12,5x25	12,5x25	12,5x25	12,5x12,5
PEZZI-SCATOLA	16	16	11	11	11	5
MQ-SC	0,5	0,5	0,34	0,34	0,34	0,07
SC-PAL	-	-	120	120	120	-
MQ-PAL	-	-	41,25	41,25	41,25	-
KG-SC	12,16	12,16	6,97	6,53	6,75	1,64
KG-PAL	-	-	836,40	783,60	810	-



**INDICATORE DI  
PROFONDITA'**  
M12,5x25  
5"x10"



**INDICATORE DI  
DIREZIONE**  
M12,5x25  
5"x10"



**SEGNALETICA VARIA**  
M12,5x25  
5"x10"

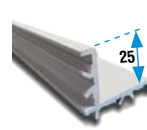

**PROFILO IN PVC  
GR 6/25**  
2,5x250  
1"x100"

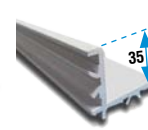

**PROFILO IN PVC  
GR 6/35**  
3,5x250  
1<sup>1/2</sup>"x100"

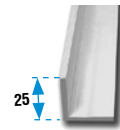

**PROFILO IN PVC A L  
GR 6/L**  
2,5x250  
1"x100"

CODICE	0003521	0003522	0003520	A003574	A003575	A003576
SPESSORE	10	10	10	-	-	-



**PIATTO DOCCIA  
BAHIA**  
15x15  
6"x6"



**PIATTO DOCCIA  
WEISS-MIX**  
15x15  
6"x6"



**BORDO PIATTO  
DOCCIA BAHIA**  
15x15  
6"x6"



**BORDO PIATTO  
DOCCIA WEISS-MIX**  
15x15  
6"x6"



**ANGOLO BORDO PIATTO  
DOCCIA BAHIA**  
15x15  
6"x6"



**ANGOLO BORDO PIATTO  
DOCCIA WEISS-MIX**  
15x15  
6"x6"

CODICE	<b>0003523</b>	<b>0003524</b>	<b>0003525</b>	<b>0003526</b>	<b>0003527</b>	<b>0003528</b>
SPESSORE			-	-	-	-

## IMBALLI

PACKING / VERPACKUNGEN / EMBALLAGES / EMBALAJES

FORMATO	<b>15x15</b>	<b>15x15</b>	<b>15x15</b>	<b>15x15</b>	<b>15x15</b>	<b>15x15</b>
PEZZI-SCATOLA	<b>22</b>	<b>22</b>	<b>8</b>	<b>8</b>	<b>2</b>	<b>2</b>
MQ-SC	<b>0,49</b>	<b>0,49</b>	<b>0,18</b>	<b>0,18</b>	<b>0,04</b>	<b>0,04</b>
SC-PAL	<b>116</b>	<b>116</b>	-	-	-	-
MQ-PAL	<b>57,42</b>	<b>57,42</b>	-	-	-	-
KG-SC	<b>8,5</b>	<b>8,5</b>	<b>4,6</b>	<b>4,6</b>	<b>1,3</b>	<b>1,3</b>
KG-PAL	<b>986</b>	<b>986</b>	-	-	-	-

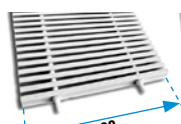

**\*GRIGLIA  
PERPENDICOLARE  
GR2/25**  
20x250  
8"x100"



**\*GRIGLIA  
PERPENDICOLARE  
GR2/35**  
20x250  
8"x100"

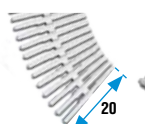

**\*GRIGLIA  
PERPENDICOLARE  
CURVABILE GR2/25/C**  
20x250  
8"x100"

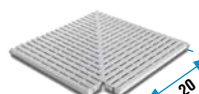

**ANGOLO GRIGLIA  
PERPENDICOLARE  
GR2/25**  
20x20  
8"x8"

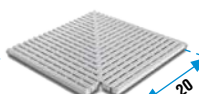

**ANGOLO GRIGLIA  
PERPENDICOLARE  
GR2/35**  
20x20  
8"x8"

CODICE	<b>A003474</b>	<b>A003480</b>	<b>A003477</b>	<b>A003489</b>	<b>A003572</b>
SPESSORE					

### \* Griglia fornita in tronchi standard di 2,5 m

Roll-up supplied in standard sections  
2,5 m in length  
Rollrost Lieferung in Standardlängen  
von 2,5 m  
Grille fournie en tronçons standard de  
2,5 m de longueur  
Rejilla suministrada en módulos  
estandar de 2,5 m de longitud

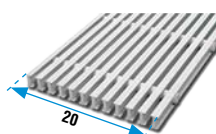

**\*\*GRIGLIA PARALLELA  
GR20**  
20x100  
8"x40"

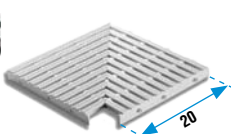

**ANGOLO GRIGLIA  
PARALLELA GR20**  
20x20  
8"x8"



**\*\*GRIGLIA  
CURVABILE GR47**  
20x100  
8"x40"

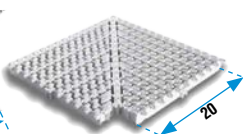

**ANGOLO GRIGLIA  
CURVABILE GR47**  
20x20  
8"x8"

CODICE	<b>A003483</b>	<b>A003637</b>	<b>A003486</b>	<b>A003573</b>
SPESSORE				

### \*\* Griglia fornita in tronchi standard di 1 m

Roll-up supplied in standard sections 1 m in length  
Rollrost Lieferung in Standardlängen von 1 m  
Grille fournie en tronçons standard de 1 m de longueur  
Rejilla suministrada en módulos estandar de 1 m de longitud



**A003577  
PILETTA IN METALLO GR7**  
Ø1 1/2" - 36 l/min



**A003536  
PILETTA ABS IN PLASTICA GR62**  
Ø1 1/2" - 40 l/min



**A003537  
PILETTA ABS IN PLASTICA GR63**  
Ø1 1/2" - 26 l/min



# H<sub>2</sub>O SPORT PROJECT

## Gres porcellanato smaltato EN 14411 Bia

Glazed porcelain stoneware / Glasiertes Feinsteinzeug / Grès cérame émaillé / Gres porcelánico esmaltado



### SISTEMA FINLANDESE / FINNISH SYSTEM / FINNISCHE SYSTEM / SYSTÈME FINLANDAIS / SISTEMA FINLANDÉS

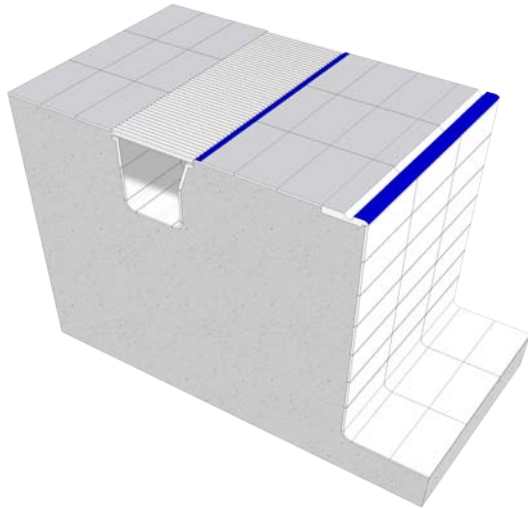

#### Imballi / Packing / Verpackungen / Emballages / Embalajes

Formato Size Format Größe Tamaño	Pezzi/Sc. Pcs/Box Pcs/Ctn Stk/Kart Piezas/Caja	Mq/Sc Sq.M/Box Mq/Ctn Qm/Kart Mq/Caja	Kg/Sc Kg/Box Kg/Ctn Kg/Kart Kg/Caja	
12,5x25	12	0,37	6,94	1
12,5x12,5	5	0,07	1,54	2
12,5x12,5	5	0,07	1,44	3

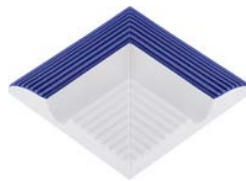

**2**  
**15**  
**0003530**  
**Angolo esterno bordo vasca**  
M12,5x12,5 / 5"x5"



**1**  
**15**  
**0003529**  
**Bordo vasca**  
M12,5x25 / 5"x10"



**3**  
**15**  
**0003531**  
**Angolo interno bordo vasca**  
M12,5x12,5 / 5"x5"

### SISTEMA ZURIGO / ZURICH SYSTEM / ZÜRICH SYSTEM / SYSTÈME ZURICH / SISTEMA DE ZURICH

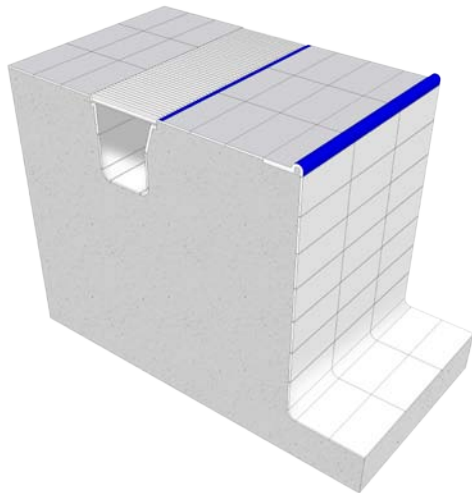

#### Imballi / Packing / Verpackungen / Emballages / Embalajes

Formato Size Format Größe Tamaño	Pezzi/Sc. Pcs/Box Pcs/Ctn Stk/Kart Piezas/Caja	Mq/Sc Sq.M/Box Mq/Ctn Qm/Kart Mq/Caja	Kg/Sc Kg/Box Kg/Ctn Kg/Kart Kg/Caja	
12,5x25	10	0,3	12	1
25x25	1	0,04	1,6	2
12,5x12,5	1	0,01	0,56	3

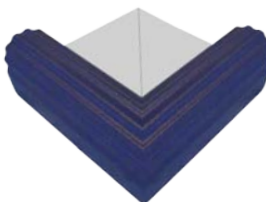

**2**  
**15**  
**0003494**  
**Angolo esterno bordo vasca**  
M12,5x12,5 / 5"x5"

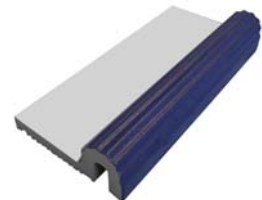

**1**  
**15**  
**0003493**  
**Bordo vasca**  
M12,5x25 / 5"x10"

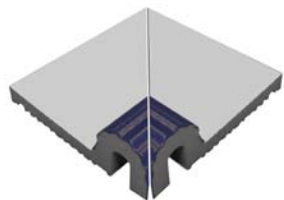

**3**  
**15**  
**0003495**  
**Angolo interno bordo vasca**  
M12,5x12,5 / 5"x5"

## Il bordo blu cobalto è smaltato

The cobalt edge is glazed / Kobaltblau Beckenrand ist glasiert / Le bord de piscine cobalt est émaillé / El bordo de piscina cobalto está esmaltado

**La superficie di vendita M12,5x25 cm è calcolata sulla base della dimensione convenzionale, uguale alla dimensione nominale più una fuga di 5 mm.**

Sales area 5"x9"<sup>76"</sup> calculated on the basis of the standard size, equal to the nominal size plus a 5 mm joint / Verkaufsoberfläche M12,5x25 cm unter der Grundlage konventioneller Abmessungen gleich der Nennabmessungen plus einer Fuge von 5 mm / Surface de vente M12,5x25 cm calculées sur la base de la dimension conventionnelle, égale à la dimension nominale plus joint de 5 mm / La superficie de venta M12,5x25 cm se calcula sobre la base de tamaño convencional, igual al tamaño nominal más una distancia de separación de 5 mm.

**SISTEMA WIESBADEN / WIESBADEN SYSTEM / WIESBADEN SYSTEM / SYSTÈME WIESBADEN / SISTEMA DE WIESBADEN**

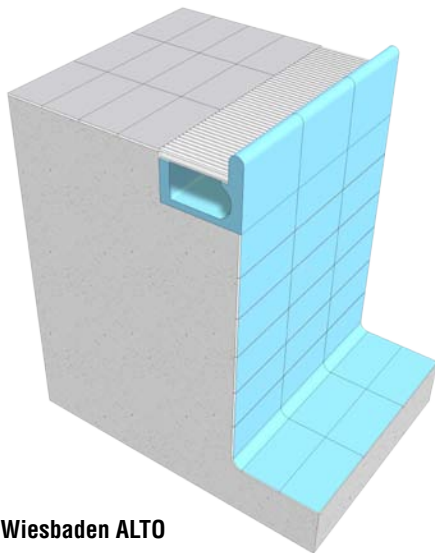

**Wiesbaden ALTO**

Imballi / Packing / Verpackungen / Emballages / Embalajes

Formato Size Format Größe Tamaño	Pezzi/Sc. Pcs/Box Pcs/Ctn Stk/Kart Piezas/Caja	Mq/Sc Sq.M/Box Mq/Ctn Om/Kart Mq/Caja	Kg/Sc Kg/Box Kg/Ctn Kg/Kart Kg/Caja	
23,8x24,5	1	0,07 / 0,05	6,60	1
23,8x24,5	1	0,07 / 0,05	6,41	2
23,8x23,8	1	0,08 / 0,05	5,58	3
23,8x23,8	1	0,08 / 0,05	5,1	4

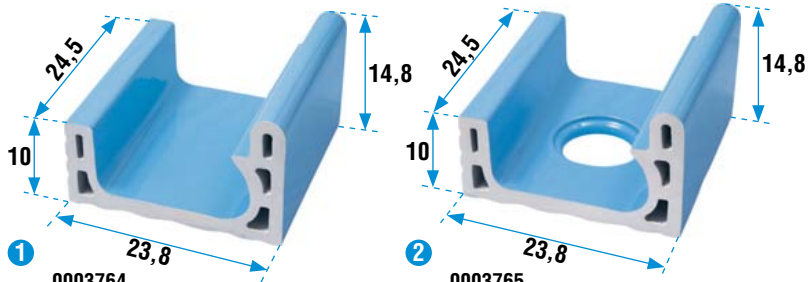

**0003764**  
**Canale alto**  
24,5x23,8 / 10"x9<sup>1/2"</sup>

**0003765**  
**Canale alto con scarico**  
24,5x23,8 / 10"x9<sup>1/2"</sup>

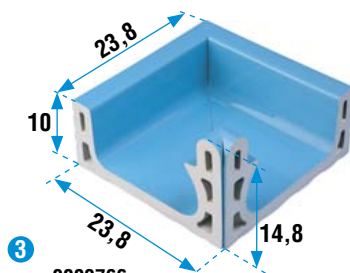

**0003766**  
**Canale alto angolo interno**  
23,8x23,8 / 9<sup>1/2"</sup>x9<sup>1/2"</sup>

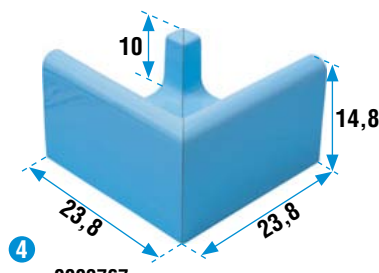

**0003767**  
**Canale alto angolo esterno**  
23,8x23,8 / 9<sup>1/2"</sup>x9<sup>1/2"</sup>

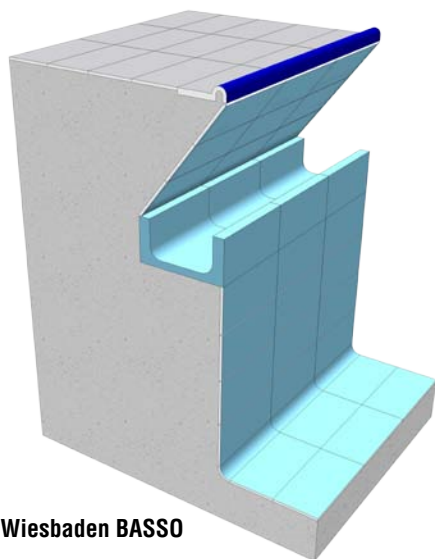

**Wiesbaden BASSO**

Imballi / Packing / Verpackungen / Emballages / Embalajes

Formato Size Format Größe Tamaño	Pezzi/Sc. Pcs/Box Pcs/Ctn Stk/Kart Piezas/Caja	Mq/Sc Sq.M/Box Mq/Ctn Om/Kart Mq/Caja	Kg/Sc Kg/Box Kg/Ctn Kg/Kart Kg/Caja	
23,5x24,5	1	0,05 / 0,03	5,02	1
23,5x24,5	1	0,05 / 0,03	5,02	2
23,5x23,5	1	0,03 / 0,01	5,1	3
23,5x23,5	1	0,03 / 0,01	5,1	4

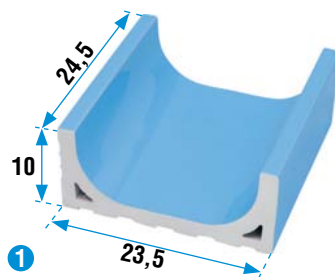

**0003532**  
**Canale basso**  
24,5x23,5 / 10"x9<sup>1/4"</sup>

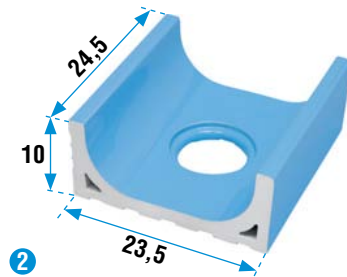

**0003533**  
**Canale basso con scarico**  
24,5x23,5 / 10"x9<sup>1/4"</sup>



**0003534**  
**Canale basso angolo interno**  
23,5x23,5 / 9<sup>1/4"</sup>x9<sup>1/4"</sup>

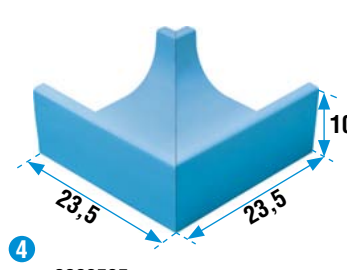

**0003535**  
**Canale basso angolo esterno**  
23,5x23,5 / 9<sup>1/4"</sup>x9<sup>1/4"</sup>

# H<sub>2</sub>O SPORT PROJECT

**Gres porcellanato smaltato EN 14411 Bla**

Glazed porcelain stoneware / Glasiertes Feinsteinzeug / Grès cérame émaillé / Gres porcelánico esmaltado

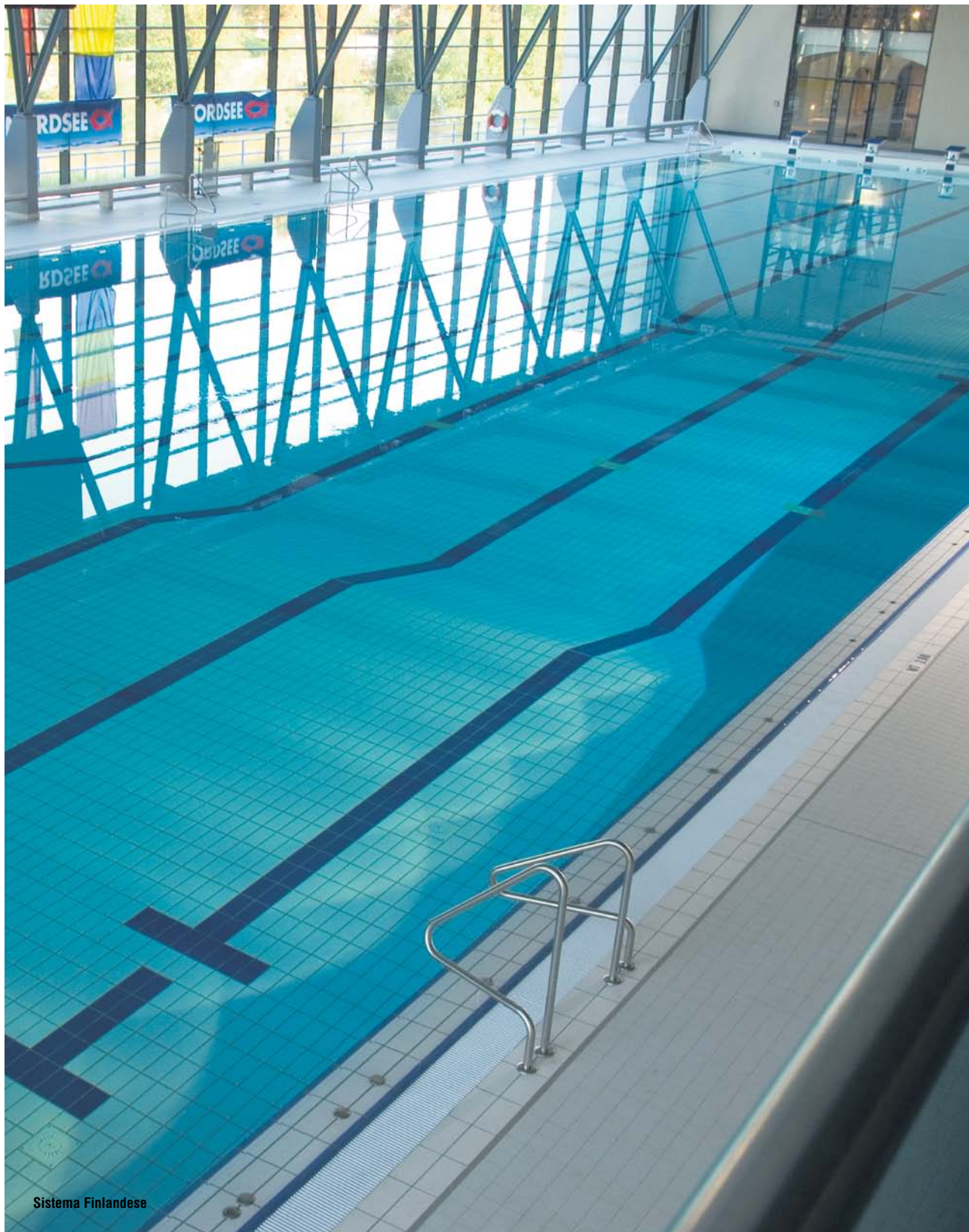

Sistema Finlandese



**Bianco Nat. Matt 12,5x25**  
**Azzurro Caraibico Nat. Matt 12,5x25**  
**Azzurro Caraibico B Matt 12,5x25**  
**Sguscia esterna Bianco 3x25**



**Bianco Nat. Matt 12,5x25**  
**Sguscia interna Bianco 3x25**  
**Sguscia interna angolo basso Bianco 3x25**





CERDISASTONE

# ALTAJ

**Gres porcellanato colorato in massa EN 14411 Bla**

Colorbody porcelain stoneware / Durghgefärbtes steinzeug / Grès cérame coloré dans le masse / Gres porcelánico coloreado en toda la masa

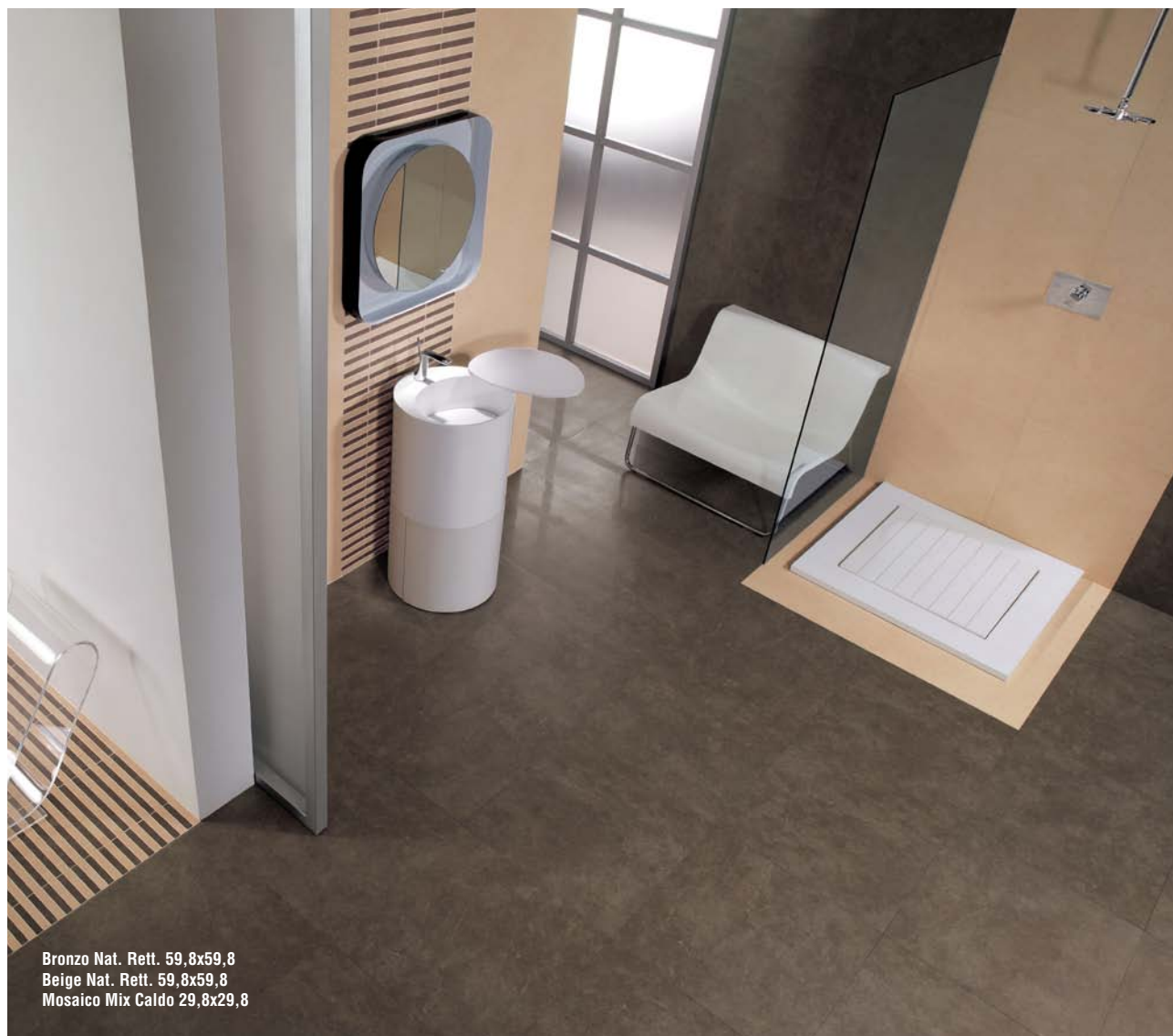



**Formati / Sizes / Grösse / Format / Tamaño:**



60,8x60,8  
59,8x59,8 Rett.  
24"x24"



30x60  
30x60 Rett.  
12"x24"



45x45  
45x45 Rett.  
18"x18"



15x45 Rett.  
6"x18"



30x30  
12"x12"

**Superfici / Surface / Oberfläche / Surface / Superficie**

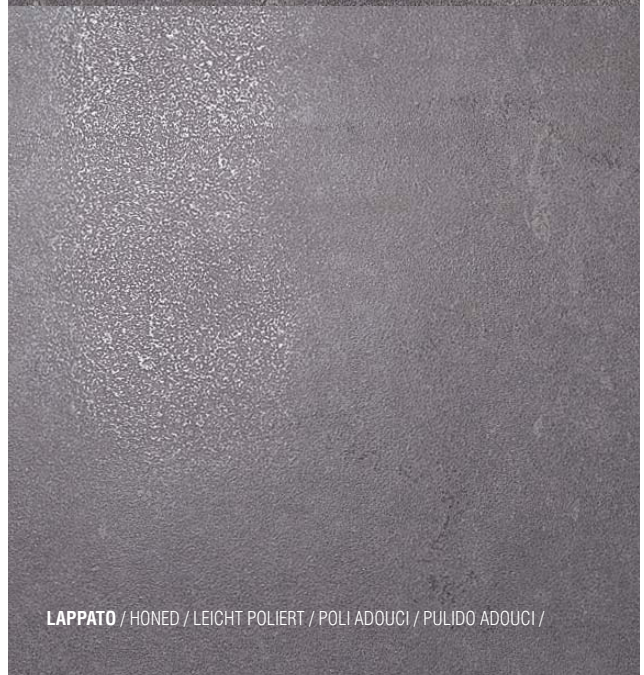
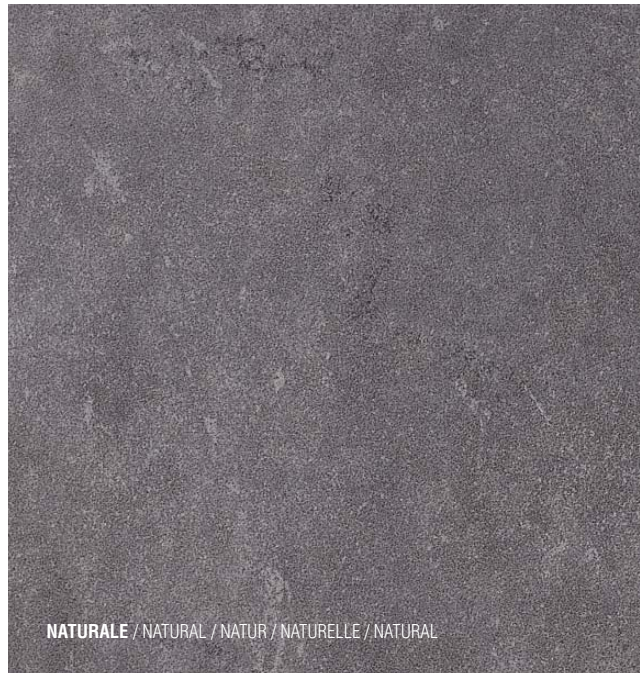



## Gres porcellanato colorato in massa EN 14411 Bla

Colorbody porcelain stoneware / Durghgefärbtes steinzeug / Grès cérame coloré dans la masse / Gres porcelánico coloreado en toda la masa



### Grigio Chiaro

### Grigio Scuro

### Nero

**NATURALE**  
NATURAL / NATUR / NATURELLE / NATURAL

**LAPPATO**  
HONED / LEICHT POLIERT / POLI ADOUCI / PULIDO

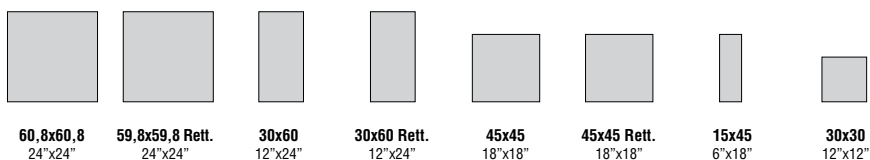
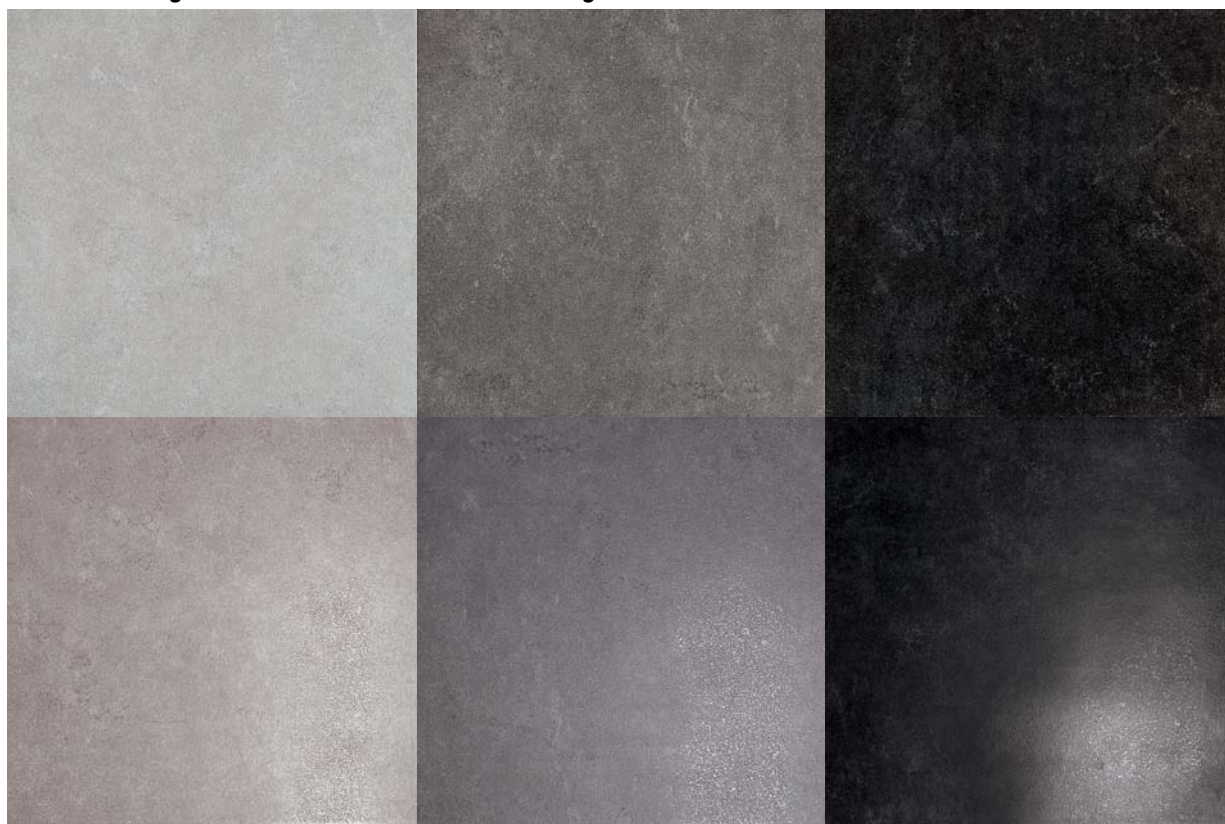

### NATURALE

NATURAL / NATUR / NATURELLE / NATURAL

<b>Grigio Chiaro</b>	<b>0050002</b>	<b>0050012</b>	<b>0077507</b>	<b>0077517</b>	<b>0077522</b>	<b>0077532</b>	-	<b>0077502</b>
<b>Grigio Scuro</b>	<b>0050001</b>	<b>0050011</b>	<b>0077506</b>	<b>0077516</b>	<b>0077521</b>	<b>0077531</b>	-	<b>0077501</b>
<b>Nero</b>	<b>0050000</b>	<b>0050010</b>	<b>0077505</b>	<b>0077515</b>	<b>0077520</b>	<b>0077530</b>	-	<b>0077500</b>
<b>Beige</b>	<b>0050004</b>	<b>0050014</b>	<b>0077509</b>	<b>0077519</b>	<b>0077524</b>	<b>0077534</b>	-	<b>0077504</b>
<b>Bronzo</b>	<b>0050003</b>	<b>0050013</b>	<b>0077508</b>	<b>0077518</b>	<b>0077523</b>	<b>0077533</b>	-	<b>0077503</b>

### LAPPATO

HONED / LEICHT POLIERT / POLI ADOUCI / PULIDO

<b>Grigio Chiaro</b>	-	<b>0050022</b>	-	<b>0077527</b>	-	<b>0077542</b>	<b>0077334</b>	-
<b>Grigio Scuro</b>	-	<b>0050021</b>	-	<b>0077526</b>	-	<b>0077541</b>	<b>0077332</b>	-
<b>Nero</b>	-	<b>0050020</b>	-	<b>0077525</b>	-	<b>0077540</b>	<b>0077330</b>	-
<b>Beige</b>	-	<b>0050024</b>	-	<b>0077529</b>	-	<b>0077544</b>	<b>0077338</b>	-
<b>Bronzo</b>	-	<b>0050023</b>	-	<b>0077528</b>	-	<b>0077543</b>	<b>0077336</b>	-

60,8x60,8 / 59,8x59,8 / 30x60 / 45x45 / 15x45 / 30x30 - 24"x24" / 12"x24" / 18"x18" / 6"x18" / 12"x12"

	NF	UPEC	Classement				
			U	P	E	C	Gel
30x30 Nat			U4	P4+	E3	C2	S
30x60 Nat./Lapp.			U4	P4	E3	C2	S
45x45 Nat./Lapp.			U4	P4+	E3	C2	S
60x60 Nat./Lapp.			U4	P4+	E3	C2	S

**Beige**

**Bronzo**

**NATURALE**  
NATURAL / NATUR / NATURELLE / NATURAL

**LAPPATO**  
HONED / LEICHT POLIERT / POLI ADOLICI / PULIDO

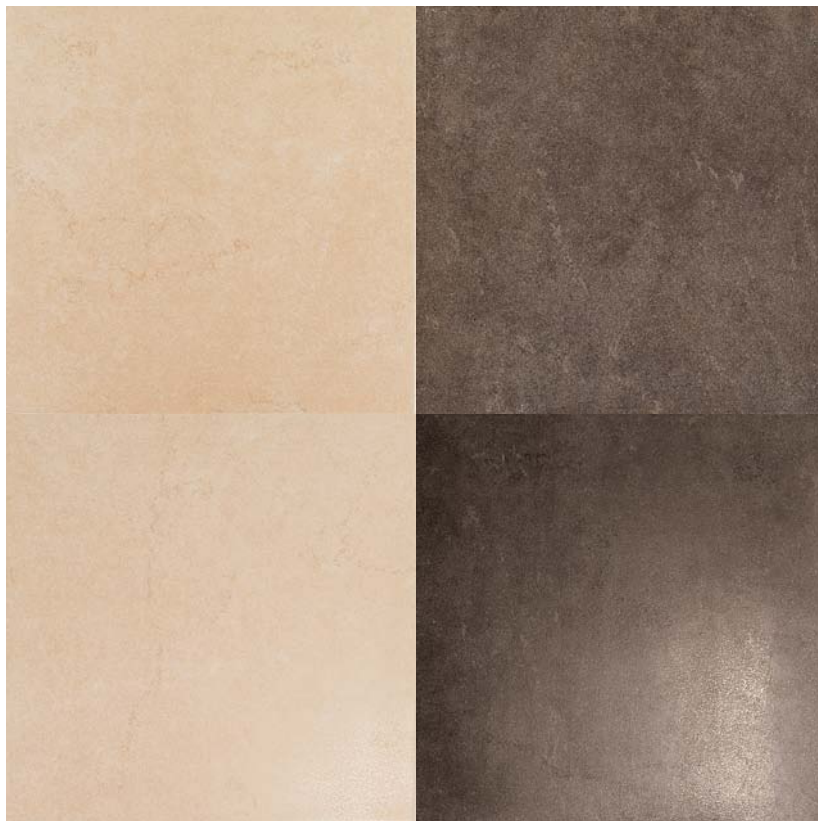

Grigio Scuro Lapp. 45x45 / 15x45  
Grigio Chiaro Lapp. 45x45 / 15x45



## Gres porcellanato colorato in massa EN 14411 Bla

Colorbody porcelain stoneware / Durghgefärbtes steinzeug / Grès cérame coloré dans la masse / Gres porcelánico coloreado en toda la masa

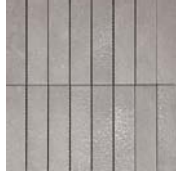

**0077457** Mosaico Grigio Ch. Lapp.  
30x30 - 12"x12"  
15 pcs x box

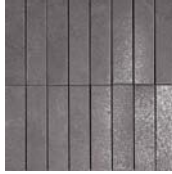

**0077456** Mosaico Grigio Sc. Lapp.  
30x30 - 12"x12"  
15 pcs x box



**0077455** Mosaico Nero Lapp.  
30x30 - 12"x12"  
15 pcs x box

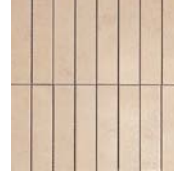

**0077459** Mosaico Beige Lapp.  
30x30 - 12"x12"  
15 pcs x box



**0077458** Mosaico Brown Lapp.  
30x30 - 12"x12"  
15 pcs x box



**0077324** Mattoncino Nero-Grigio  
30x30 - 12"x12"  
15 pcs x box



**0077329** Mattoncino Beige-Brown  
30x30 - 12"x12"  
15 pcs x box



**0050025** Mosaico Mix Freddo  
29,8x29,8 - 12"x12"  
4 pcs x box

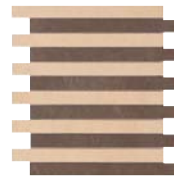

**0050026** Mosaico Mix Caldo  
29,8x29,8 - 12"x12"  
4 pcs x box



**0077335** List. Borchia Grigio Ch. Lapp.  
15x45 - 6"x18"  
6 pcs x box



**0077333** List. Borchia Grigio Sc. Lapp.  
15x45 - 6"x18"  
6 pcs x box



**0077356** List. Vetro Grigio  
3x30 - 1 1/4"x12"  
6 pcs x box



**0077339** List. Borchia Beige Lapp.  
15x45 - 6"x18"  
6 pcs x box



**0077337** List. Borchia Brown Lapp.  
15x45 - 6"x18"  
6 pcs x box



**0077357** List. Vetro Bruno  
3x30 - 1 1/4"x12"  
6 pcs x box

**0077359** List. Alluminio 3x60 - 1 1/4"x24"  
8 pcs x box



**BATTISCOPA**  
**9,5x60,8**  
4"x24"  
8 pcs x box



**BATTISCOPA**  
**7,5x30**  
3"x12"  
44 pcs x box

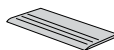

**GRADINO**  
**INCISO RETT.**  
**29,8x59,8**  
12"x24"  
5 pcs x box



**GRADINO**  
**INCISO**  
**30x30**  
12"x12"  
13 pcs x box

### NATURALE

NATURAL / NATUR / NATURELLE / NATURAL

	0050007	0077297	0050017	0077287
<b>Grigio Chiaro</b>				
<b>Grigio Scuro</b>	0050006	0077296	0050016	0077286
<b>Nero</b>	0050005	0077295	0050015	0077285
<b>Beige</b>	0050009	0077299	0050019	0077289
<b>Bronzo</b>	0050008	0077298	0050018	0077288

### Imballi / Packing / Verpackungen / Emballages / Embalajes

Formato	Pezzi/Sc.	Mq/Sc	Sc/Pal	Mq/Pal	Kg/Sc	Kg/Pal
Size	Pcs/Box	Sq.M/Box	Box/Pal	Sq.M/Pal	Kg/Box	Kg/Pal
Grösse	Pcs/Ctn	Mq/Ctn	Ctn/Pal	Mq/Pal	Kg/Ctn	Kg/Pal
Format	Stck/Kart	Qm/Kart	Kart/Pal	Qm/Pal	Kg/Kart	Kg/Pal
Tamaño	Piezas/Caja	Mq/Caja	Caja/Pal	Mq/Pal	Kg/Caja	Kg/Pal
<b>60,8x60,8</b>	<b>4</b>	<b>1,48</b>	<b>24</b>	<b>35,50</b>	<b>37,4</b>	<b>897,60</b>
<b>59,8x59,8</b>	<b>4</b>	<b>1,43</b>	<b>24</b>	<b>34,32</b>	<b>36,4</b>	<b>873,60</b>
<b>45x45</b>	<b>8</b>	<b>1,62</b>	<b>44</b>	<b>71,30</b>	<b>34,6</b>	<b>1522,40</b>
<b>30x60</b>	<b>8</b>	<b>1,44</b>	<b>32</b>	<b>46,10</b>	<b>31,5</b>	<b>1008,00</b>
<b>30x30</b>	<b>13</b>	<b>1,17</b>	<b>40</b>	<b>46,80</b>	<b>26,5</b>	<b>1068,00</b>
<b>15x45</b>	<b>16</b>	<b>1,08</b>	<b>-</b>	<b>-</b>	<b>21,5</b>	<b>-</b>



**Nero Lapp. Rett. 30x60**  
**Grigio Chiaro Lapp. Rett. 30x30**  
**Mosaico Nero Lapp. 30x30**  
**Mosaico Grigio Chiaro Lapp. 30x30**

# CEMENTI

**Gres porcellanato colorato in massa EN 14411 Bla**

Colorbody porcelain stoneware / Durghgefärbtes steinzeug / Grès cérame coloré dans le masse / Gres porcelánico coloreado en toda la masa





**Formati / Sizes / Grösse / Format / Tamaño:**



60,8x60,8  
60x60 Rett.  
24"x24"



30x60  
30x60 Rett.  
12"x24"



# CEMENTI

## Gres porcellanato colorato in massa EN 14411 Bla

Colorbody porcelain stoneware / Durghgefärbtes steinzeug / Grès cérame coloré dans le masse / Gres porcelánico coloreado en toda la masa



**Bianco**

**Grigio**

**Antracite**

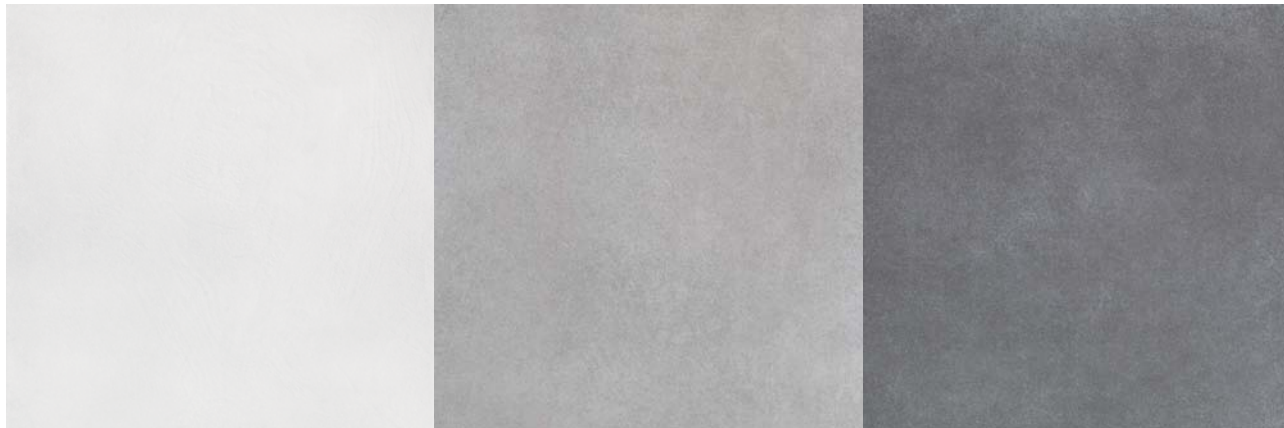

**Avorio**

**Fango**

**Nero**

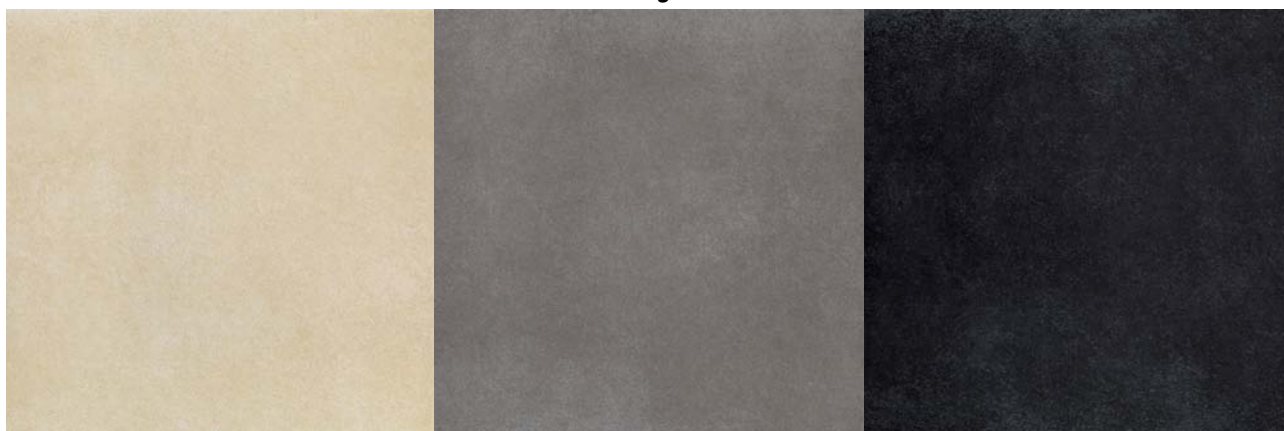

\* Solo i formati 60x60 e 30x60 rettificati sono modulari tra loro con fuga 2 mm.

Only rectified sizes 60x60 and 30x60 can be used in modular combinations, with 2 mm joint / Nur die rektifizierten Formate 60x60 und 30x60 passen mit 2-mm-Fuge modular zueinander  
Seuls les formats 60x60 et 30x60 rectifiés peuvent se combiner (avec joint de 2 mm) / Sólo los formatos de 60 x 60 y 30 x 60 rectificados se pueden combinar entre sí, dejando juntas de 2 mm

\*\* Il 30x60 naturale non è modulare con il 60,8x60,8 e con i formati rettificati.

Natural size 30x60 cannot be used in modular combinations with size 60,8x60,8 or rectified sizes / Das normale Format 30x60 passt nicht modular zum Format 60,8x60,8 und zu den rektifizierten Formaten  
Le format 30x60 nat ne peut pas se combiner avec le format 60,8x60,8 et avec les formats rectifiés / El formato de 30 x 60 natural no se puede combinar con el de 60,8 x 60,8 ni con los formatos rectificados

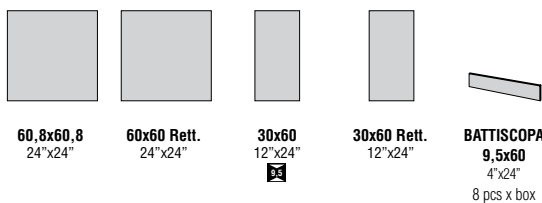

### NATURALE

NATURAL / NATUR / NATURELLE / NATURAL

	Bianco	0050300	0050301	0050303	0050302	0050305
<b>Grigio</b>	<b>0050320</b>	<b>0050321</b>	<b>0050323</b>	<b>0050322</b>	<b>0050325</b>	
<b>Antracite</b>	<b>0050330</b>	<b>0050331</b>	<b>0050333</b>	<b>0050332</b>	<b>0050335</b>	
<b>Avorio</b>	<b>0050310</b>	<b>0050311</b>	<b>0050313</b>	<b>0050312</b>	<b>0050315</b>	
<b>Fango</b>	<b>0050350</b>	<b>0050351</b>	<b>0050353</b>	<b>0050352</b>	<b>0050355</b>	
<b>Nero</b>	<b>0050360</b>	<b>0050361</b>	<b>0050363</b>	<b>0050362</b>	<b>0050365</b>	

### Imballi / Packing / Verpackungen / Emballages / Embalajes

Formato	Pezzi/Sc.	Mq/Sc	Sc/Pal	Mq/Pal	Kg/Sc	Kg/Pal
Size	Pcs/Box	Sq.M/Box	Box/Pal	Sq.M/Pal	Kg/Box	Kg/Pal
Größe	Pcs/Ctn	Mq/Ctn	Ctn/Pal	Mq/Pal	Kg/Ctn	Kg/Pal
Format	Stck/Kart	Qm/Kart	Kart/Pal	Qm/Pal	Kg/Kart	Kg/Pal
Tamaño	Piezas/Caja	Mq/Caja	Caja/Pal	Mq/Pal	Kg/Caja	Kg/Pal
<b>60,8x60,8</b>	<b>4</b>	<b>1,48</b>	<b>24</b>	<b>35,52</b>	<b>37,40</b>	<b>897,60</b>
<b>60x60 Rett.</b>	<b>4</b>	<b>1,44</b>	<b>24</b>	<b>34,56</b>	<b>36,00</b>	<b>864,00</b>
<b>30x60</b>	<b>8</b>	<b>1,44</b>	<b>32</b>	<b>46,08</b>	<b>32,50</b>	<b>1040,00</b>
<b>30x60 Rett.</b>	<b>6</b>	<b>1,08</b>	<b>32</b>	<b>34,56</b>	<b>24,50</b>	<b>784,00</b>

NF	UPEC	Classement			
		U	P	E	C
30x60 Nat. ≈ 9,5 mm	U4	P3	E3	C2	S
30x60 Rett. ≈ 10,5 mm	U4	P4+	E3	C2	S
60x60 Nat. - Rett.	U4	P4+	E3	C2	S



**0050304** Mosaico Bianco Rett.  
30x30 - 12"x12"  
4 pcs x box



**0050324** Mosaico Grigio Rett. 30x30  
30x30 - 12"x12"  
4 pcs x box



**0050334** Mosaico Antracite Rett.  
30x30 - 12"x12"  
4 pcs x box

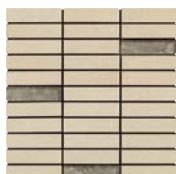

**0050314** Mosaico Avorio Rett.  
30x30 - 12"x12"  
4 pcs x box



**0050354** Mosaico Fango Rett.  
30x30 - 12"x12"  
4 pcs x box

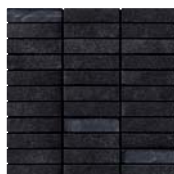

**0050364** Mosaico Nero Rett.  
30x30 - 12"x12"  
4 pcs x box



**0076769** Fascia Mosaico Acciaio 4x30 - 1 1/4"x12"  
6 pcs x box

**0050370** Matita Alluminio 1x60 - 1/2"x24"  
8 pcs x box

Mosaico Grigio Rett. 30x30  
Grigio Rett. 30x60  
Grigio Rett. 60x60

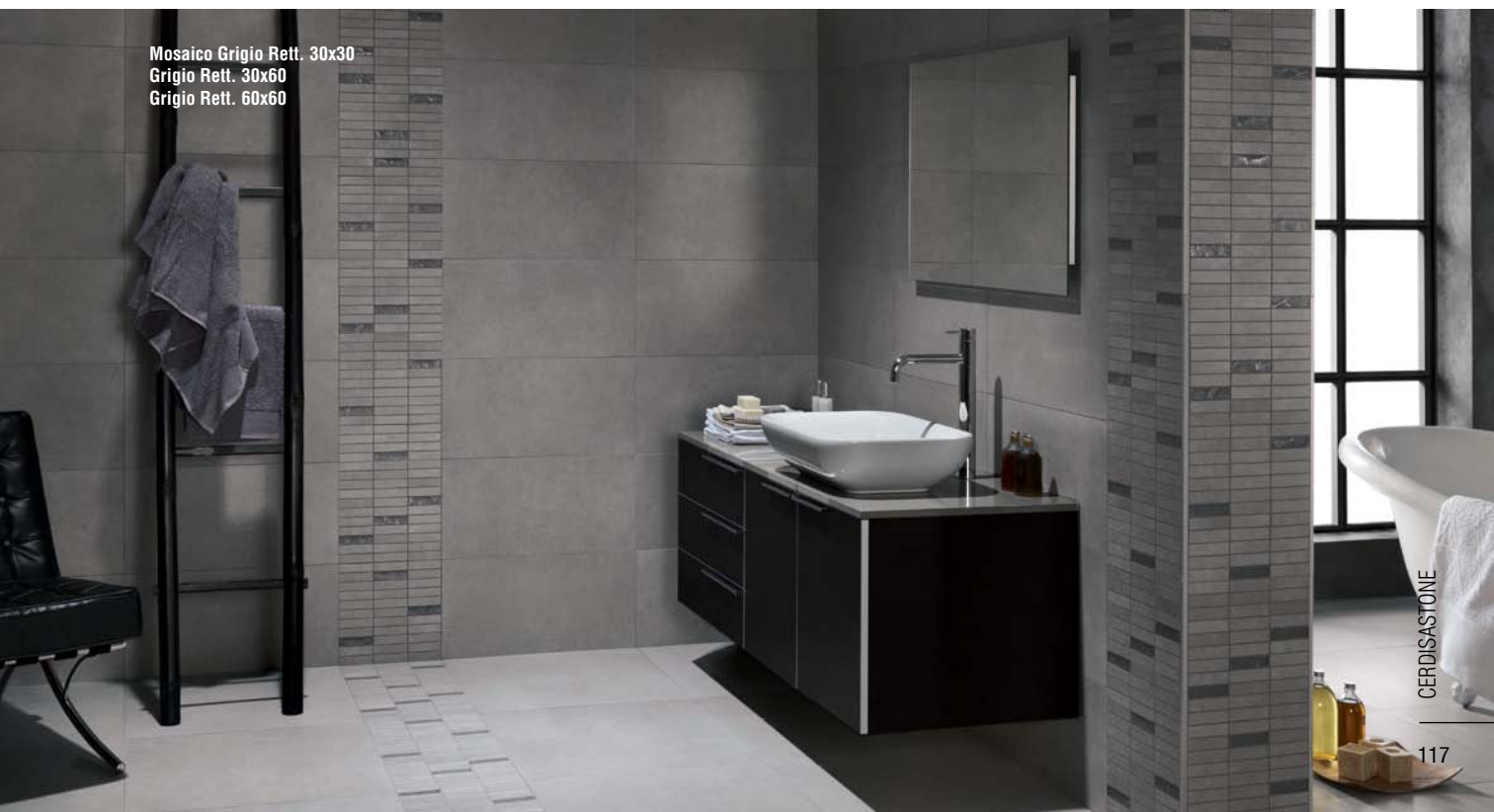



# CHALET

**Gres porcellanato colorato in massa EN 14411 Bla**

Colorbody porcelain stoneware / Durghgefärbtes steinzeug / Grès cérame coloré dans la masse / Gres porcelánico coloreado en toda la masa



**Bianco Rett. 20x80**  
**Bianco Grip 20x80**



**Ciliegio Grip 20x80**  
**Elemento "L" Ciliegio Grip 20x80x5**



**Ciliegio Rett. 13x80**



**Formati / Sizes / Grösse / Format / Tamaño:**



20x80 Rett.  
8"x32"



13x80 Rett.  
5<sup>1/8</sup>"x32"

**Superfici / Surface / Oberfläche / Surface / Superficie**

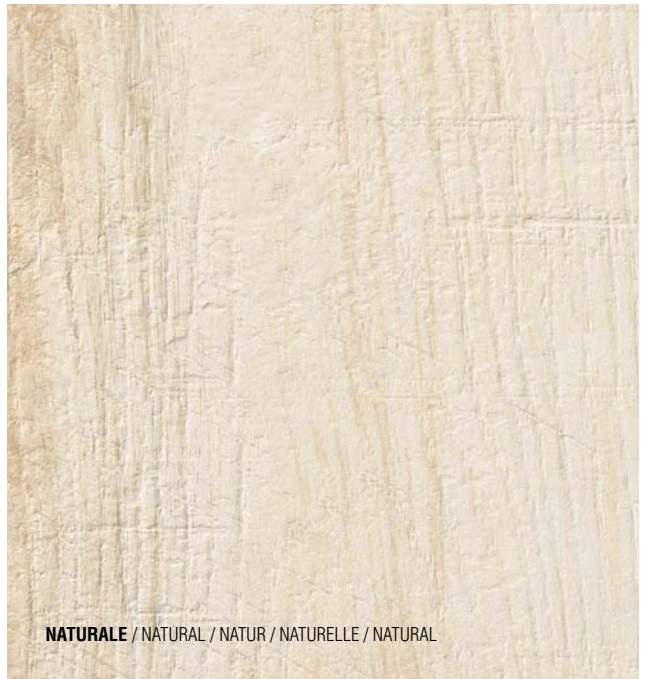

# CHALET

Gres porcellanato colorato in massa EN 14411 Bla

Colorbody porcelain stoneware / Durghgefärbtes steinzeug / Grès cérame coloré dans le masse / Gres porcelánico coloreado en toda la masa

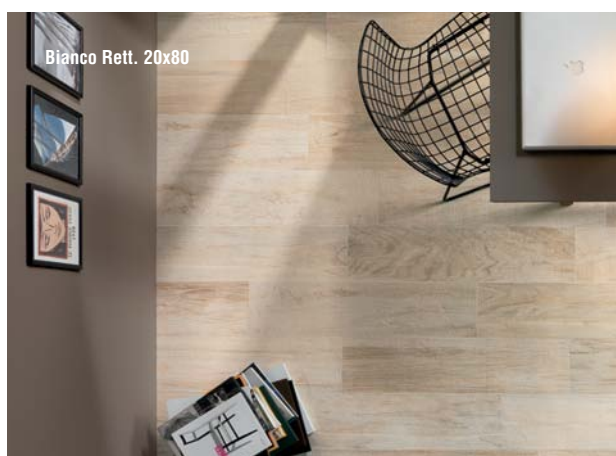
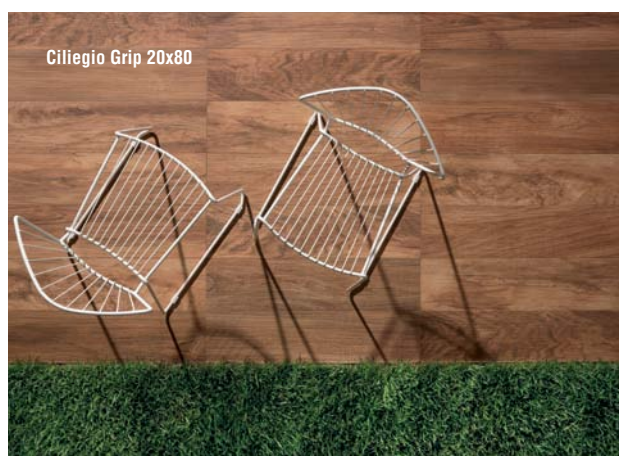



Ciliegio Rett. 20x80  
Ciliegio Rett. 13x80

## Gres porcellanato colorato in massa EN 14411 Bla

Colorbody porcelain stoneware / Durhgefärbtes steinzeug / Grès cérame coloré dans la masse / Gres porcelánico coloreado en toda la masa



Naturale Grip > 0,60 dry / > 0,60 wet  
> 0,60 dry / da 0,50 a 0,60 wet

ANSI A 137.1:2012  
Nat. R9 A  
Grip R11 A+B+C  
DCOF ≥ 0,42



Classement  
20x80 Nat. U4 P3 E3 C2 S  
20x80 Grip U4 P3 E3 C2 S

### NATURALE

NATURAL / NATUR / NATURELLE / NATURAL

### GRIP

GRIP SURFACE / SURFACE GRIP / GRIFFIGE OBERFLÄCHE / SUPERFICIE ANTIDESLIZANTE



20x80  
8"x32"



13x80  
5 1/8"x32"



**BATTISCOPA**  
8x40  
3 1/8"x16"  
24 pcs x box



**GRAD.LINEARE**  
20x60  
8"x24"  
4 pcs x box



**ELEMENTO L**  
20x80x5  
8"x32"x2"  
2 pcs x box

### ELEMENTO A L

20 cm

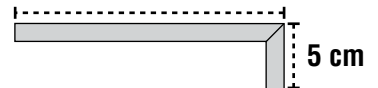

### NATURALE

NATURAL / NATUR / NATURELLE / NATURAL

<b>Bianco</b>	<b>0040202</b>	<b>0040201</b>	<b>0040203</b>	<b>0040204</b>	-
<b>Rovere</b>	<b>0040222</b>	<b>0040221</b>	<b>0040223</b>	<b>0040224</b>	-
<b>Ciliegio</b>	<b>0040242</b>	<b>0040241</b>	<b>0040243</b>	<b>0040244</b>	-
<b>Nero</b>	<b>0040262</b>	<b>0040261</b>	<b>0040263</b>	<b>0040264</b>	-

### GRIP

GRIP SURFACE / SURFACE GRIP / GRIFFIGE OBERFLÄCHE / SUPERFICIE ANTIDESLIZANTE

<b>Bianco</b>	<b>0040212</b>	<b>0040211</b>	-	-	<b>0040213</b>
<b>Rovere</b>	<b>0040232</b>	<b>0040231</b>	-	-	<b>0040233</b>
<b>Ciliegio</b>	<b>0040252</b>	<b>0040251</b>	-	-	<b>0040253</b>
<b>Nero</b>	<b>0040272</b>	<b>0040271</b>	-	-	<b>0040273</b>

### GRADINO LINEARE

20 cm



incollato

pasted / stecken / collé / pegado

**Avvertenze per la posa: si consiglia la posa a correre del materiale, sfalsando il lato più lungo per massimo 15 cm sulla lunghezza del pezzo adiacente. Utilizzare una fuga di minimo 2 mm.**

Attention when laying: we recommend laying in a brick pattern, staggering the slats so that the longer side is offset a maximum of 15 cm against its neighbour. Leave a minimum 2 mm gap between slats.  
Hinweise für die Verlegung: Es wird die fortlaufende Verlegung des Materials empfohlen, mit Versetzung der Längsseite um maximal 15 cm zum anliegenden Teil. Eine Fuge von mindestens 2 mm vorsehen.  
Avertissement pour la pose : une pose à l'anglaise du matériau est conseillée, en décalant le côté le plus long de 15 cm maximum sur la longueur de l'élément adjacent. Utiliser un joint d'au moins 2 mm.  
Advertencia para la colocación: aconsejamos la colocación del material a junta partida, escalonando el lado más largo como máximo 15 cm sobre la longitud de la pieza contigua. Utilícese una junta de 2 mm como mínimo.

### Imballi / Packing / Verpackungen / Emballages / Embalajes

Formato	Pezzi/Sc.	Mq/Sc	Sc/Pal	Mq/Pal	Kg/Sc	Kg/Pal
Size	Pcs/Box	Sq.M/Box	Box/Pal	Sq.M/Pal	Kg/Box	Kg/Pal
Größe	Pcs/Ctn	Mq/Ctn	Ctn/Pal	Mq/Pal	Kg/Ctn	Kg/Pal
Format	Stk/Kart	Qm/Kart	Kart/Pal	Qm/Pal	Kg/Kart	Kg/Pal
Tamaño	Piezas/Caja	Mq/Caja	Caja/Pal	Mq/Pal	Kg/Caja	Kg/Pal
<b>20x80</b>	<b>8</b>	<b>1,28</b>	<b>48</b>	<b>61,44</b>	<b>28,0</b>	<b>1296,0</b>
<b>13x80</b>	<b>12</b>	<b>1,25</b>	<b>54</b>	<b>67,50</b>	<b>27,5</b>	<b>1425,6</b>



Nero Rett. 20x80

# CITYLINE

**Gres porcellanato colorato in massa EN 14411 Bla**

Colorbody porcelain stoneware / Durghgefärbtes steinzeug / Grès cérame coloré dans le masse / Gres porcelánico coloreado en toda la masa







Taupe Strutt. Rett. Lapp. 30x60  
Taupe 45x45

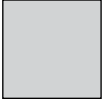

Mosaico Purple Rett. Lapp. 59,8x59,8  
Matita Onda Argento 2,5x59,8  
Purple Rett. Lapp. 59,8x59,8

**Formati / Sizes / Grösse / Format / Tamaño:**

			
40x80,3 39,6x79,4 Rett. 16"x32"	60,8x60,8 59,8x59,8 Rett. 24"x24"	30x60 30x60 Rett. 12"x24"	45x45 45x45 Rett. 18"x18"

**Superfici / Surface / Oberfläche / Surface / Superficie**

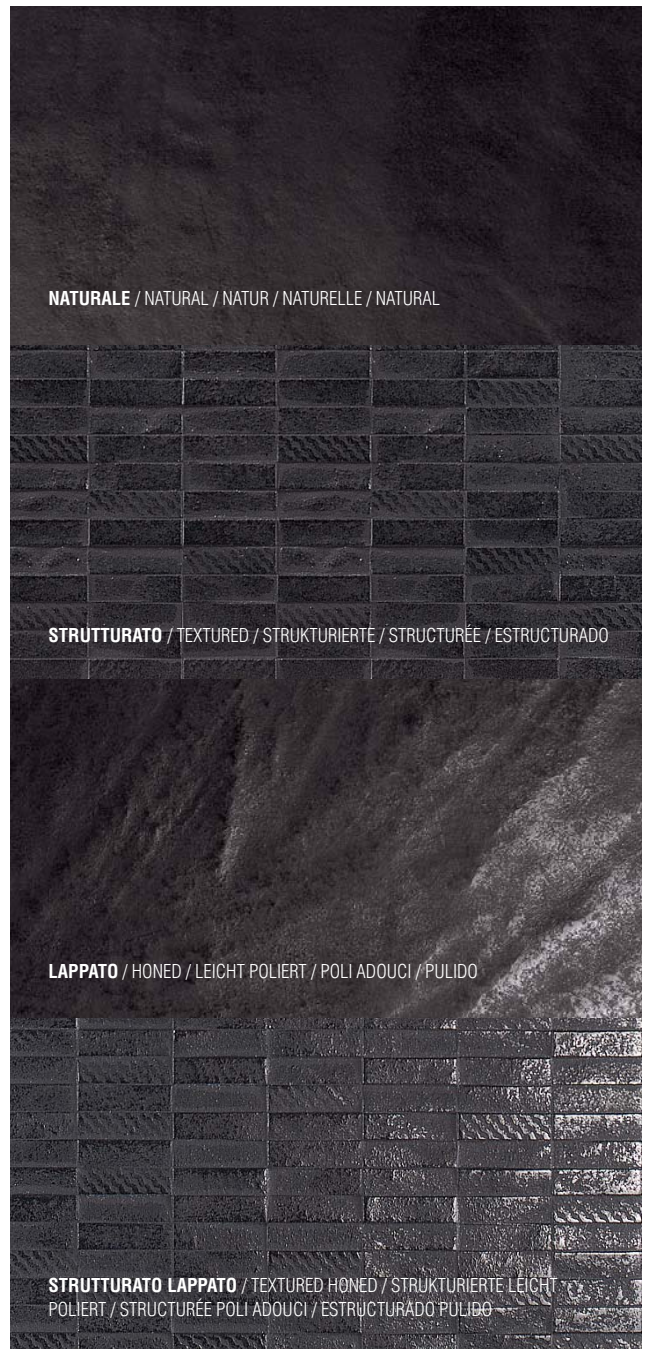

**NATURALE** / NATURAL / NATUR / NATURELLE / NATURAL

**STRUTTURATO** / TEXTURED / STRUKTURIERTE / STRUCTURÉE / ESTRUCTURADO

**LAPPATO** / HONED / LEICHT POLIERT / POLI ADOUCI / PULIDO

**STRUTTURATO LAPPATO** / TEXTURED HONED / STRUKTURIERTE LEICHT  
POLIERT / STRUCTURÉE POLI ADOUCI / ESTRUCTURADO PULIDO



# CITYLINE

## Gres porcellanato colorato in massa EN 14411 B1a

Colorbody porcelain stoneware / Durghgefärbtes steinzeug / Grès cérame coloré dans la masse / Gres porcelánico coloreado en toda la masa



60,8x60,8

White

White

Taupe

Black

**NATURALE**  
NATURAL / NATUR / NATURELLE / NATURAL

**LAPPATO**  
HONED / LEICHT POLIERT / POLI ADOLICI / PULIDO

**STRUTTURATO**  
TEXTURED / STRUKTURIERTE / STRUCTUREE / ESTRUCTURADO

**STRUTTURATO LAPPATO**  
TEXTURED HONED / STRUKTURIERTE LEICHT POLIERT  
STRUCTURÉE POLI ADOLICI / ESTRUCTURADO PULIDO



	Classement				Gel
	U	P	E	C	
30x60 Nat./Lapp.	U4	P3	E3	C2	S
45x45 Nat./Lapp.	U4	P4	E3	C2	S
45x45 Purple	U4	P4+	E3	C2	S
60x60 Nat./Lapp.	U4	P4+	E3	C2	S

Sand

Brown

Purple

**NATURALE**  
NATURAL / NATUR / NATURELLE / NATURAL

**LAPPATO**  
HONED / LEICHT POLIERT / POLI ADOLUCI / PULIDO

**STRUTTURATO**  
TEXTURED / STRUKTURIERTE / STRUCTUREE / ESTRUCTURADO

**STRUTTURATO LAPPATO**  
TEXTURED HONED / STRUKTURIERTE LEICHT POLIERT  
STRUCTUREE POLI ADOLUCI / ESTRUCTURADO PULIDO

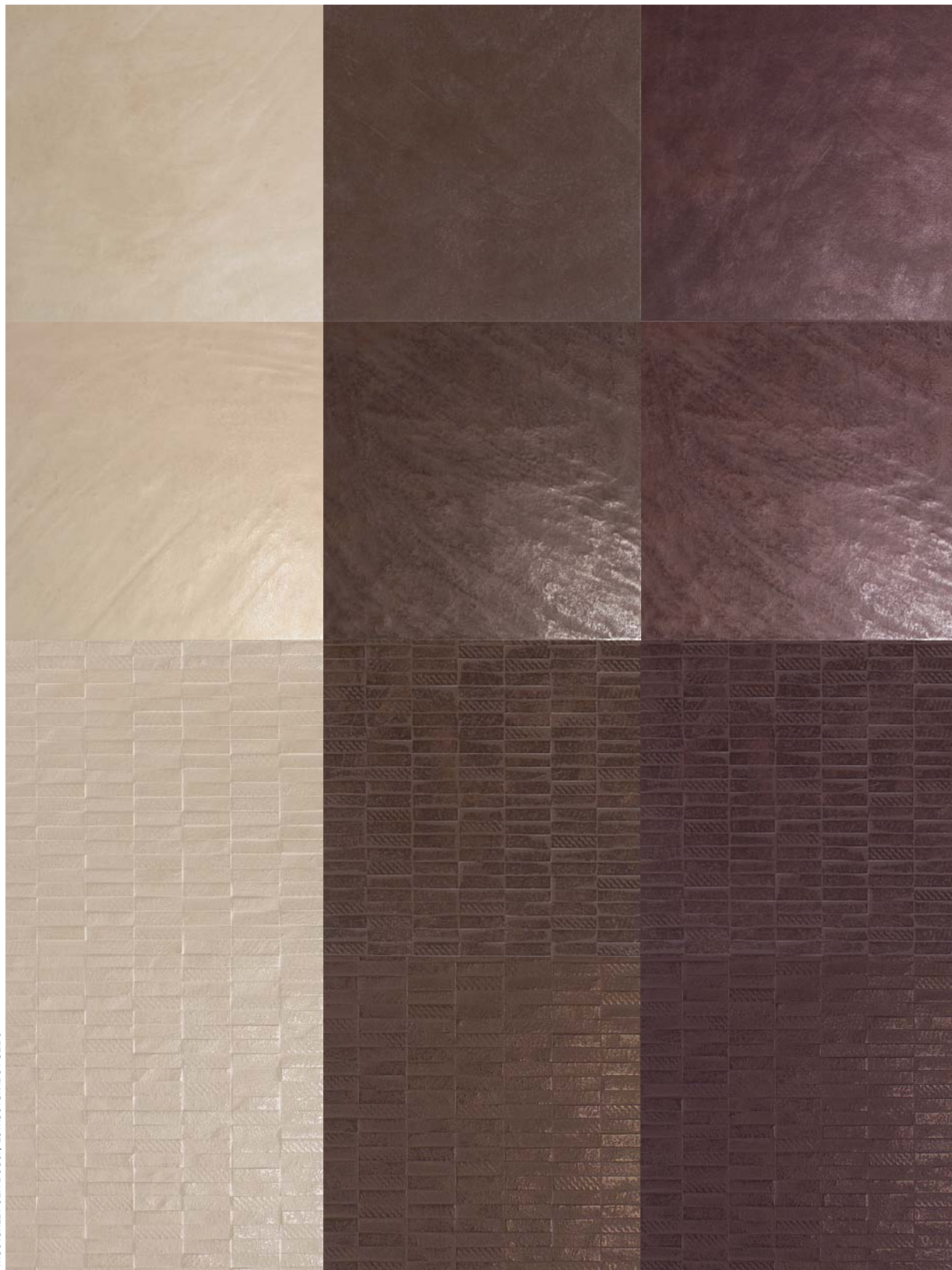

# CITYLINE

## Gres porcellanato colorato in massa EN 14411 Bla

Colorbody porcelain stoneware / Durhgefärbtes steinzeug / Grès cérame coloré dans la masse / Gres porcelánico coloreado en toda la masa

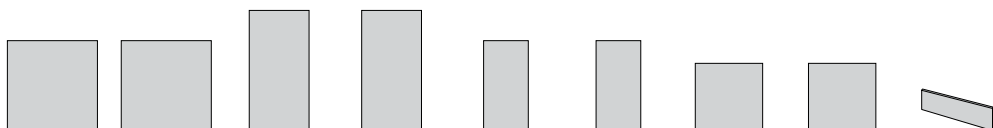

60,8x60,8 24"x24"    59,8x59,8 24"x24"    40x80,3 16"x32"    39,6x79,4 16"x32"    30x60 12"x24"    30x60 Rett. 12"x24"    45x45 18"x18"    45x45 Rett. 18"x18"    **BATTISCOPA** 9x45 3"x18" 16 pcs x box

### NATURALE

NATURAL / NATUR / NATURELLE / NATURAL

White	0050285	0050288	0040085	0040087	0075185	0075188	0078285	0078288	0078287
Taupe	0050270	0050273	0040070	0040072	0075170	0075173	0078270	0078273	0078272
Black	0050260	0050263	0040060	0040062	0075160	0075163	0078260	0078263	0078262
Sand	0050280	0050283	0040080	0040082	0075180	0075183	0078280	0078283	0078282
Brown	0050265	0050268	0040065	0040067	0075165	0075168	0078265	0078268	0078267
Purple	0050275	0050278	0040075	0040077	0075175	0075178	0078275	0078278	0078277

### LAPPATO

HONED / LEICHT POLIERT / POLI ADOUCI / PULIDO

White	-	0050286	-	0040086	-	0075187	-	0078286	-
Taupe	-	0050271	-	0040071	-	0075172	-	0078271	-
Black	-	0050261	-	0040061	-	0075162	-	0078261	-
Sand	-	0050281	-	0040081	-	0075182	-	0078281	-
Brown	-	0050266	-	0040066	-	0075167	-	0078266	-
Purple	-	0050276	-	0040076	-	0075177	-	0078276	-

### STRUTTURATO

TEXTURED / STRUKTURIERTE / STRUCTURÉE / ESTRUCTURADO

White	-	-	-	-	0075186	0075159	-	-	-
Taupe	-	-	-	-	0075171	0075156	-	-	-
Black	-	-	-	-	0075161	0075154	-	-	-
Sand	-	-	-	-	0075181	0075158	-	-	-
Brown	-	-	-	-	0075166	0075155	-	-	-
Purple	-	-	-	-	0075176	0075157	-	-	-

### STRUTTURATO LAPPATO

TEXTURED HONED / STRUKTURIERTE LEICHT POLIERT / STRUCTURÉE POLI ADOUCI / ESTRUCTURADO PULIDO

White	-	-	-	-	-	0075189	-	-	-
Taupe	-	-	-	-	-	0075174	-	-	-
Black	-	-	-	-	-	0075164	-	-	-
Sand	-	-	-	-	-	0075184	-	-	-
Brown	-	-	-	-	-	0075169	-	-	-
Purple	-	-	-	-	-	0075179	-	-	-

### Imballi / Packing / Verpackungen / Emballages / Embalajes

Formato	Pezzi/Sc.	Mq/Sc	Sc/Pal	Mq/Pal	Kg/Sc	Kg/Pal
Size	Pcs/Box	Sq.M/Box	Box/Pal	Sq.M/Pal	Kg/Box	Kg/Pal
Grösse	Pcs/Ctn	Mq/Ctn	Ctn/Pal	Mq/Pal	Kg/Ctn	Kg/Pal
Format	Stck/Kart	Qm/Kart	Kart/Pal	Qm/Pal	Kg/Kart	Kg/Pal
Tamaño	Piezas/Caja	Mq/Caja	Caja/Pal	Mq/Pal	Kg/Caja	Kg/Pal
40x80,3	4	1,29	48	61,92	27,60	1324,8
39,6x79,4 Rett.	4	1,26	48	60,48	27,00	1296,0
60,8x60,8	4	1,48	24	35,52	37,40	897,6
59,8x59,8 Rett.	4	1,43	24	34,32	34,60	830,4
30x60	8	1,44	32	46,08	32,50	1040,0
45x45	8	1,62	44	71,28	38,15	1678,6

NF	UPEC	Classement			
		U	P	E	C
30x60 Nat./Lapp.	U4	P3	E3	C2	S
45x45 Nat./Lapp.	U4	P4	E3	C2	S
45x45 Purple	U4	P4+	E3	C2	S
60x60 Nat./Lapp.	U4	P4+	E3	C2	S



**0050287** Mosaico White Rett. Lapp. 19,8x59,8 - 8"x24"  
4 pcs x box



**0050272** Mosaico Taupe Rett. Lapp. 19,8x59,8 - 8"x24"  
4 pcs x box



**0050262** Mosaico Black Rett. Lapp. 19,8x59,8 - 8"x24"  
4 pcs x box



**0050282** Mosaico Sand Rett. Lapp. 19,8x59,8 - 8"x24"  
4 pcs x box



**0050267** Mosaico Brown Rett. Lapp. 19,8x59,8 - 8"x24"  
4 pcs x box



**0050277** Mosaico Purple Rett. Lapp. 19,8x59,8 - 8"x24"  
4 pcs x box



**0050269** Matita Onda Argento 2,5x59,8 - 1"x24"  
6 pcs x box



**0050274** Matita Onda Bronzo 2,5x59,8 - 1"x24"  
6 pcs x box



**Black 45x45**  
**White Rett. Lapp. 45x45**  
**Mosaico Black Rett. Lapp. 19,8x59,8**

# ESSERE

**Gres porcellanato colorato in massa EN 14411 Bla**

Colorbody porcelain stoneware / Durghgefärbtes steinzeug / Grès cérame coloré dans le masse / Gres porcelánico coloreado en toda la masa



Black 40x80,3

40x80,3 - 16"x32"



**Black**

**Brown**



**Formati / Sizes / Grösse / Format / Tamaño:**



40x80,3  
16"x32"



**40x80,3**  
16"x32"

**NATURALE**

NATURAL / NATUR / NATURELLE / NATURAL

**Black 0040030**

**Brown 0040035**

**GRIP**

GRIP SURFACE / SURFACE GRIP  
GRIFFIGE OBERFLÄCHE / SUPERFICIE ANTIDESLIZANTE

**Black 0040031**

**Brown -**

**Imballi / Packing / Verpackungen / Emballages / Embalajes**

Formato	Pezzi/Sc.	Mq/Sc	Sc/Pal	Mq/Pal	Kg/Sc	Kg/Pal
Size	Pcs/Box	Sq.M/Box	Box/Pal	Sq.M/Pal	Kg/Box	Kg/Pal
Grösse	Pcs/Ctn	Mq/Ctn	Ctn/Pal	Mq/Pal	Kg/Ctn	Kg/Pal
Format	Stck/Kart	Qm/Ctn	Kart/Pal	Qm/Pal	Kg/Kart	Kg/Pal
Tamaño	Piezas/Caja	Mq/Caja	Caja/Pal	Mq/Pal	Kg/Caja	Kg/Pal
<b>40x80,3</b>	<b>3</b>	<b>0,97</b>	<b>56</b>	<b>54,32</b>	<b>24</b>	<b>1344</b>

**NATURALE**  
NATURAL / NATUR / NATURELLE / NATURAL

**GRIP**  
GRIP SURFACE / SURFACE GRIP / GRIFFIGE OBERFLÄCHE / SUPERFICIE ANTIDESLIZANTE

# HOME TEAK

Gres porcellanato colorato in massa EN 14411 Bla

Colorbody porcelain stoneware / Durghgefärbtes steinzeug / Grès cérame coloré dans la masse / Gres porcelánico coloreado en toda la masa





**Formati / Sizes / Grösse / Format / Tamaño:**



25x100 Rett.  
10"x40"



16,5x100 Rett.  
6<sup>1/2</sup>"x40"

**Superfici / Surface / Oberfläche / Surface / Superficie**

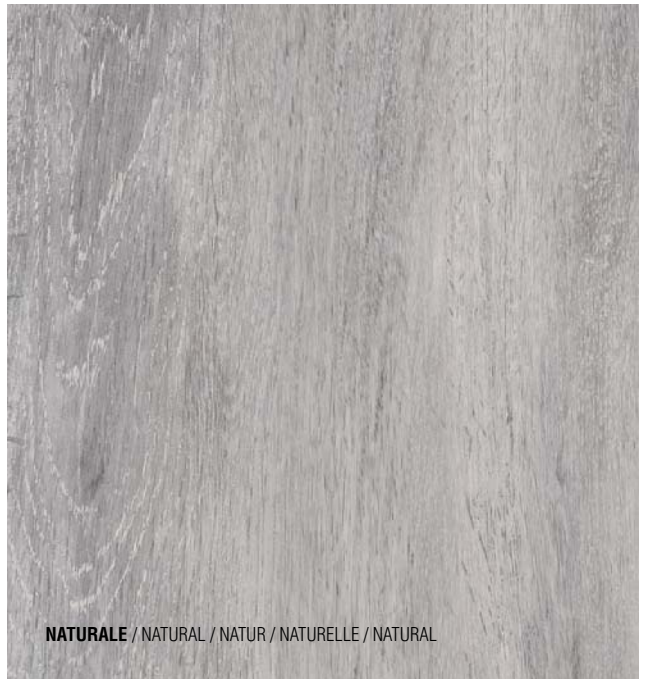



# HOME TEAK

**Gres porcellanato colorato in massa EN 14411 Bla**

Colorbody porcelain stoneware / Durghgefärbtes steinzeug / Grès cérame coloré dans le masse / Gres porcelánico coloreado en toda la masa



Cloud Teak Nat. Rett. 16,5x100 / 25x100  
Mosaico 3D Veneziana Cloud Teak 25x100



Ice Teak Nat. Rett. 25x100  
Decoro Ice Teak Listone 25x100



Cream Teak Nat. Rett. 25x100  
Decoro Cream Teak Listone 25x100



London Teak Nat. Rett. 16,5x100 / 25x100  
Mosaico 3D Veneziana Cloud Teak 25x100

# HOME TEAK

**Gres porcellanato colorato in massa EN 14411 Bla**

Colorbody porcelain stoneware / Durghgefärbtes steinzeug / Grès cérame coloré dans le masse / Gres porcelánico coloreado en toda la masa





London Teak Nat. Rett. 25x100  
Mosaico 3D Veneziana London Teak 25x100



Honey Teak Grip 25x100  
Cloud Teak Nat. Rett. 25x100  
Decoro Cloud Teak Tozzetto 25x25

# HOME TEAK

## Gres porcellanato colorato in massa EN 14411 Bla

Colorbody porcelain stoneware / Durghgefärbtes steinzeug / Grès cérame coloré dans la masse / Gres porcelánico coloreado en toda la masa



Grip > 0,60 dry / > 0,60 wet



Grip > 36 dry / > 36 wet

Ice Teak

Cloud Teak

London Teak

Dark Teak

Honey Teak

Cream Teak



**NATURALE**  
NATURAL / NATUR / NATURELLE / NATURAL

**GRIP**  
GRIP SURFACE / SURFACE GRIP / GRIFFIGE OBERFLÄCHE / SUPERFICIE ANTIDESLIZANTE

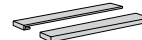
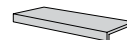
25x100 Rett.  
1"x40"16,5x100 Rett.  
6<sup>1</sup>/<sub>2</sub>"x40"BATTISCOPA 8x100  
3<sup>1</sup>/<sub>4</sub>"x40"  
5 pcs x boxGRAD.  
COSTA RETTA  
16,5x100x3x3+16,5x100  
6<sup>1</sup>/<sub>2</sub>"x40"x1<sup>2</sup>/<sub>2</sub>"x1<sup>2</sup>/<sub>2</sub>"x6<sup>1</sup>/<sub>2</sub>"x40"  
2 cmp x boxANG. DX. GRAD.  
COSTA RETTA  
16,5x100x3x3+16,5x100  
6<sup>1</sup>/<sub>2</sub>"x40"x1<sup>2</sup>/<sub>2</sub>"x1<sup>2</sup>/<sub>2</sub>"x6<sup>1</sup>/<sub>2</sub>"x40"  
2 cmp x boxANG. SX. GRAD.  
COSTA RETTA  
16,5x100x3x3+16,5x100  
6<sup>1</sup>/<sub>2</sub>"x40"x1<sup>2</sup>/<sub>2</sub>"x1<sup>2</sup>/<sub>2</sub>"x6<sup>1</sup>/<sub>2</sub>"x40"  
2 cmp x boxELEMENTO L  
15x60x5  
6"x24"x2"  
2 pcs x box**NATURALE**

NATURAL / NATUR / NATURELLE / NATURAL

Ice Teak	0040401	0040402	0040409	0040410	0040411	0040412	-
Cloud Teak	0040511	0040512	0040519	0040520	0040521	0040522	-
London Teak	0040541	0040542	0040549	0040550	0040551	0040552	-
Dark Teak	0040571	0040572	0040579	0040580	0040581	0040582	-
Honey Teak	0040461	0040462	0040469	0040470	0040471	0040472	-
Cream Teak	0040431	0040432	0040439	0040440	0040441	0040442	-

**GRIP**

GRIP SURFACE / SURFACE GRIP / GRIFFIGE OBERFLÄCHE / SUPERFICIE ANTIDESLIZANTE

Ice Teak	0040421	0040422	-	-	-	-	0040423
Cloud Teak	0040531	0040532	-	-	-	-	0040533
London Teak	0040561	0040562	-	-	-	-	0040563
Dark Teak	0040591	0040592	-	-	-	-	0040593
Honey Teak	0040481	0040482	-	-	-	-	0040483
Cream Teak	0040451	0040452	-	-	-	-	0040453

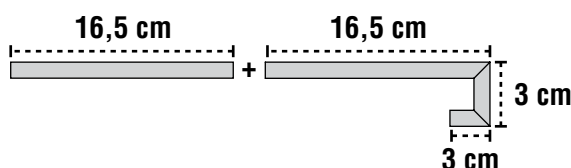
**COMPOSIZIONE GRADINO COSTA RETTA**

**Avvertenze per la posa: si consiglia la posa a correre del materiale, sfalsando il lato più lungo per massimo 20 cm sulla lunghezza del pezzo adiacente. Utilizzare una fuga di minimo 2 mm.**

Attention when laying: we recommend laying in a brick pattern, staggering the slats so that the longer side is offset a maximum of 20 cm against its neighbour. Leave a minimum 2 mm gap between slats.

Hinweise für die Verlegung: Es wird die fortlaufende Verlegung des Materials empfohlen, mit Versetzung der Längsseite um maximal 20 cm zum anliegenden Teil. Eine Fuge von mindestens 2 mm vorsehen.

Avertissement pour la pose : une pose à l'anglaise du matériau est conseillée, en décalant le côté le plus long de 20 cm maximum sur la longueur de l'élément adjacent. Utiliser un joint d'au moins 2 mm.

Advertencia para la colocación: aconsejamos la colocación del material a junta partida, escalonando el lado más largo como máximo 20 cm. sobre la longitud de la pieza contigua. Utilícese una junta de 2 mm. como mínimo.

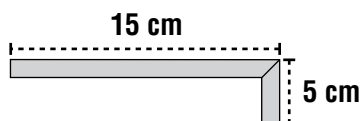
**ELEMENTO A L****Imballi / Packing / Verpackungen / Embalajes / Embalajes**

Formato	Pezzi/Sc.	Mq/Sc	Sc/Pal	Mq/Pal	Kg/Sc	Kg/Pal
Size	Pcs/Box	Sq.M/Box	Box/Pal	Sq.M/Pal	Kg/Box	Kg/Pal
Größe	Pcs/Ctn	Mq/Ctn	Ctn/Pal	Mq/Pal	Kg/Ctn	Kg/Pal
Format	Stck/Kart	Qm/Kart	Kart/Pal	Qm/Pal	Kg/Kart	Kg/Pal
Tamaño	Piezas/Caja	Mq/Caja	Caja/Pal	Mq/Pal	Kg/Caja	Kg/Pal
25x100	6	1,50	32	48,00	36	1152
16,5x100	9	1,49	36	53,64	35	1260

# HOME TEAK

## Gres porcellanato colorato in massa EN 14411 Bla

Colorbody porcelain stoneware / Durghgefärbtes steinzeug / Grès cérame coloré dans la masse / Gres porcelánico coloreado en toda la masa



Grip > 0,60 dry / > 0,60 wet



Grip > 36 dry / > 36 wet



**0040403** Decoro Ice Teak Listone 25x100 - 10"x40" 2 pcs x box

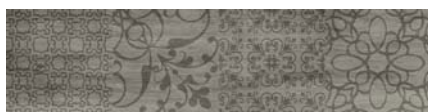

**0040543**  
Decoro London Teak Listone  
25x100 - 10"x40" 2 pcs x box



**0040573**  
Decoro Dark Teak Listone  
25x100 - 10"x40" 2 pcs x box

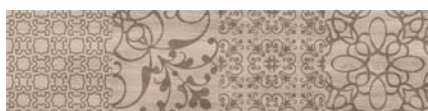

**0040433**  
Decoro Cream Teak Listone  
25x100 - 10"x40" 2 pcs x box

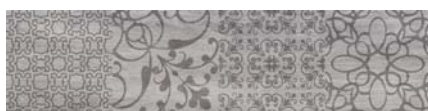

**0040513**  
Decoro Cloud Teak Listone  
25x100 - 10"x40" 2 pcs x box

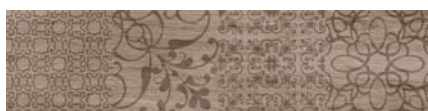

**0040463**  
Decoro Honey Teak Listone  
25x100 - 10"x40" 2 pcs x box



**0040404** Decoro Ice Teak Tozzetto 25x25 - 10"x10" \*4 MIXED pcs x box



**0040544**  
Decoro London Teak Tozzetto  
25x25 - 10"x10" \*4 MIXED pcs x box



**0040574**  
Decoro Dark Teak Tozzetto  
25x25 - 10"x10" \*4 MIXED pcs x box

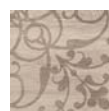

**0040434**  
Decoro Cream Teak Tozzetto  
25x25 - 10"x10" \*4 MIXED pcs x box



**0040514**  
Decoro Cloud Teak Tozzetto  
25x25 - 10"x10" \*4 MIXED pcs x box



**0040464**  
Decoro Honey Teak Tozzetto  
25x25 - 10"x10" \*4 MIXED pcs x box



**0040405** Decoro Ice Teak Listone 16,5x100 - 6 1/2"x40" 3 pcs x box



**0040545**  
Decoro London Teak Listone  
16,5x100 - 6 1/2"x40" 3 pcs x box



**0040575**  
Decoro Dark Teak Listone  
16,5x100 - 6 1/2"x40" 3 pcs x box



**0040435**  
Decoro Cream Teak Listone  
16,5x100 - 6 1/2"x40" 3 pcs x box



**0040515**  
Decoro Cloud Teak Listone  
16,5x100 - 6 1/2"x40" 3 pcs x box



**0040465**  
Decoro Honey Teak Listone  
16,5x100 - 6 1/2"x40" 3 pcs x box



**0040406** Decoro Ice Teak Tozzetto 16,5x16,5 - 6 1/2"x6 1/2" \*4 MIXED pcs x box



**0040546**  
Decoro London Teak Tozzetto  
16,5x16,5 - 6 1/2"x6 1/2" \*4 MIXED pcs x box



**0040576**  
Decoro Dark Teak Tozzetto  
16,5x16,5 - 6 1/2"x6 1/2" \*4 MIXED pcs x box



**0040436**  
Decoro Cream Teak Tozzetto  
16,5x16,5 - 6 1/2"x6 1/2" \*4 MIXED pcs x box



**0040516**  
Decoro Cloud Teak Tozzetto  
16,5x16,5 - 6 1/2"x6 1/2" \*4 MIXED pcs x box



**0040466**  
Decoro Honey Teak Tozzetto  
16,5x16,5 - 6 1/2"x6 1/2" \*4 MIXED pcs x box



**0040407** Mosaico 3D Veneziana Ice Teak 25x100 - 10"x40" 2 pcs x box



**0040547**  
Mosaico 3D Veneziana London Teak  
25x100 - 10"x40" 2 pcs x box



**0040577**  
Mosaico 3D Veneziana Dark Teak  
25x100 - 10"x40" 2 pcs x box



**0040437**  
Mosaico 3D Veneziana Cream Teak  
25x100 - 10"x40" 2 pcs x box



**0040517**  
Mosaico 3D Veneziana Cloud Teak  
25x100 - 10"x40" 2 pcs x box



**0040467**  
Mosaico 3D Veneziana Honey Teak  
25x100 - 10"x40" 2 pcs x box



**0040408** Mosaico Listelli Ice Teak 25x50 - 10"x20" 4 pcs x box



**0040548**  
Mosaico Listelli London Teak  
25x50 - 10"x20" 4 pcs x box



**0040578**  
Mosaico Listelli Dark Teak  
25x50 - 10"x20" 4 pcs x box



**0040438**  
Mosaico Listelli Cream Teak  
25x50 - 10"x20" 4 pcs x box



**0040518**  
Mosaico Listelli Cloud Teak  
25x50 - 10"x20" 4 pcs x box



**0040468**  
Mosaico Listelli Honey Teak  
25x50 - 10"x20" 4 pcs x box

**\* Tutti i decori TOZZETTO sono inscatolati mescolando in maniera casuale i disegni della piastrella.**

\* All the TOZZETTO decorative pieces are boxed randomly to mix the patterns on the tiles.

\* Beim Verpacken aller Dekore TOZZETTO wurden die Zeichnungen der Fliese nach dem Zufallsprinzip gemischt.

\* Tous les décors TOZZETTO sont mis en boîte en mélangeant de manière aléatoire les motifs du carrelage.

\* Todas las decoraciones TOZZETTO se presentan en estuches con los dibujos de la baldosa mezclados al azar.



# INDIAN SILK

**Gres porcellanato colorato in massa EN 14411 Bla**

Colorbody porcelain stoneware / Durghgefärbtes steinzeug / Grès cérame coloré dans le masse / Gres porcelánico coloreado en toda la masa





**Formati / Sizes / Größe / Format / Tamaño:**



60,8x60,8  
 59,8x59,8 Rett.  
 24"x24"



29,8x59,8 Rett.  
 12"x24"



14,8x59,8 Rett.  
 6"x24"



29,8x29,8 Rett.  
 12"x12"

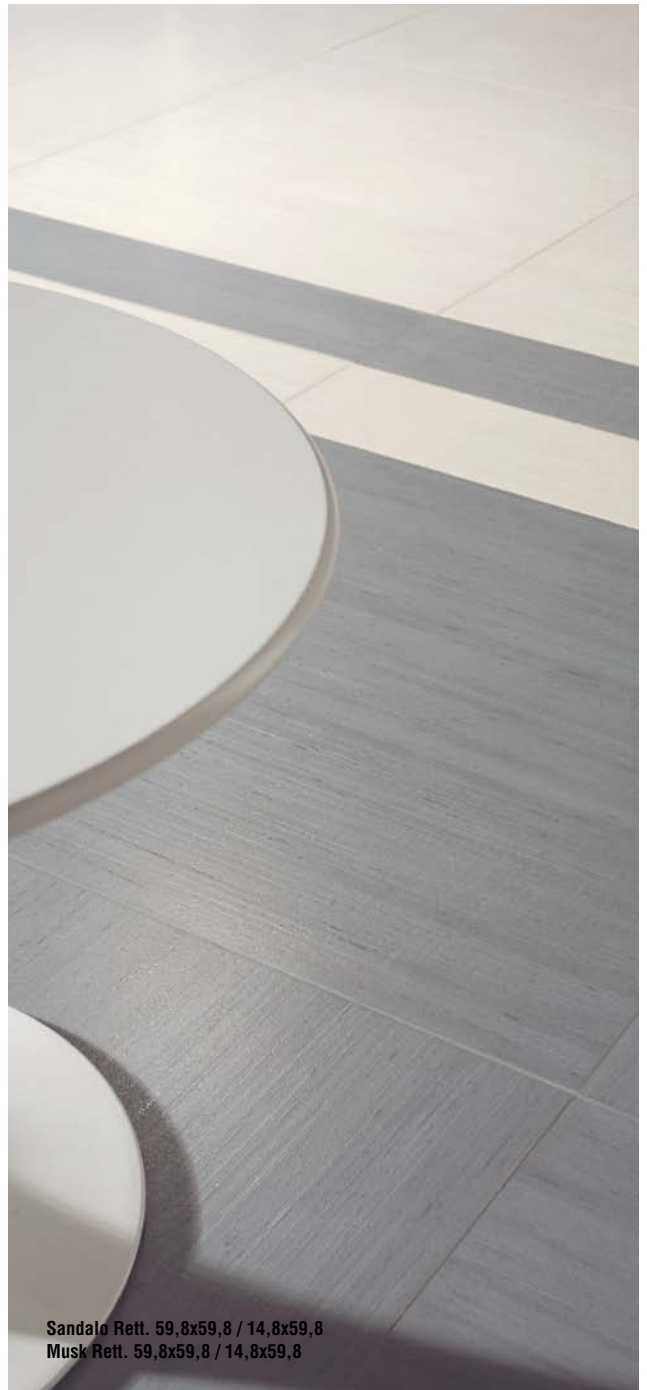

# INDIAN SILK

## Gres porcellanato colorato in massa EN 14411 Bla

Colorbody porcelain stoneware / Durghgefärbtes steinzeug / Grès cérame coloré dans le masse / Gres porcelánico coloreado en toda la masa



Musk

Sandalo

Porpora



Magnolia

Cannella

Cocco



60,8x60,8  
24"x24"



59,8x59,8 Rett.  
24"x24"



29,8x59,8 Rett.  
12"x24"



14,8x59,8  
6"x24"



29,8x29,8  
12"x12"



BATTISCOPA  
9,5x60,8  
4"x24"  
8 pcs x box

### NATURALE

NATURAL / NATUR / NATURELLE / NATURAL

	0050104	0050114	0050119	0050129	0050124	0050109
<b>Musk</b>						
<b>Sandalo</b>	0050103	0050113	0050118	0050128	0050123	0050108
<b>Porpora</b>	0050140	0050141	0050142	0050144	0050143	0050145
<b>Magnolia</b>	0050100	0050110	0050115	0050125	0050120	0050105
<b>Cannella</b>	0050101	0050111	0050116	0050126	0050121	0050106
<b>Cocco</b>	0050102	0050112	0050117	0050127	0050122	0050107

### Imballi / Packing / Verpackungen / Emballages / Embalajes

Formato	Pezzi/Sc.	Mq/Sc	Sc/Pal	Mq/Pal	Kg/Sc	Kg/Pal
Size	Pcs/Box	Sq./Box	Box/Pal	Sq./M/Pal	Kg/Box	Kg/Pal
Grösse	Pcs/Ctn	Mq/Ctn	Ctn/Pal	Mq/Pal	Kg/Ctn	Kg/Pal
Format	Stck/Kart	Qm/Kart	Kart/Pal	Qm/Pal	Kg/Kart	Kg/Pal
Tamaño	Piezas/Caja	Mq/Caja	Caja/Pal	Mq/Pal	Kg/Caja	Kg/Pal
60,8x60,8	4	1,48	24	35,52	37,4	897,60
59,8x59,8	4	1,43	24	34,32	36,4	873,60
29,8x59,8	6	1,07	32	34,24	27,1	867,20
29,8x29,8	11	0,98	40	39,20	24,8	992,00
14,8x59,8	11	0,97	33	32,01	24,7	815,10

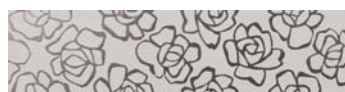

**0050134** Listello Seta Musk 14,8x59,8 - 6"x24"  
6 pcs x box



**0050133** Listello Seta Sandalo 14,8x59,8 - 6"x24"  
6 pcs x box



**0050146** Listello Seta Porpora 14,8x59,8 - 6"x24"  
6 pcs x box



**0050139** Listello Seta Musk 3x59,8 - 1 1/4"x24"  
6 pcs x box



**0050138** Listello Seta Sandalo 3x59,8 - 1 1/4"x24"  
6 pcs x box



**0050147** Listello Seta Porpora 3x59,8 - 1 1/4"x24"  
6 pcs x box



**0050130** Listello Seta Magnolia 14,8x59,8 - 6"x24"  
6 pcs x box

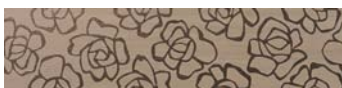

**0050131** Listello Seta Cannella 14,8x59,8 - 6"x24"  
6 pcs x box



**0050132** Listello Seta Cocco 14,8x59,8 - 6"x24"  
6 pcs x box



**0050135** Listello Seta Magnolia 3x59,8 - 1 1/4"x24"  
6 pcs x box

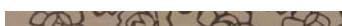

**0050136** Listello Seta Cannella 3x59,8 - 1 1/4"x24"  
6 pcs x box



**0050137** Listello Seta Cocco 3x59,8 - 1 1/4"x24"  
6 pcs x box



**0050156** Mosaico Brik Coc/San/Musk  
29,8x29,8 - 12"x12"  
4 pcs x box



**0050155** Mosaico Brik Por/San/Musk  
29,8x29,8 - 12"x12"  
4 pcs x box



**0050154** Mosaico Brik Can/Coc/Mag  
29,8x29,8 - 12"x12"  
4 pcs x box



**0050153** Mosaico Design Coc/San/Musk  
29,8x29,8 - 12"x12"  
4 pcs x box



**0050152** Mosaico Design Por/San/Musk  
29,8x29,8 - 12"x12"  
4 pcs x box



**0050151** Mosaico Design Can/Coc/Mag  
29,8x29,8 - 12"x12"  
4 pcs x box



**0050150** Listello Mix Flowers San/Mus  
10x59,8 - 4"x24"  
6 pcs x box



**0050149** Listello Mix Flowers Can/Coc  
10x59,8 - 4"x24"  
6 pcs x box



**0050148** Listello Mix Flowers Por/Mag  
10x59,8 - 4"x24"  
6 pcs x box

# LEGNOTECH

**Gres porcellanato colorato in massa EN 14411 Bla**

Colorbody porcelain stoneware / Durghgefärbtes steinzeug / Grès cérame coloré dans le masse / Gres porcelánico coloreado en toda la masa





**Formati / Sizes / Grösse / Format / Tamaño:**



20x80 Rett.  
8"x32"



13x80 Rett.  
5"x32"

**Superfici / Surface / Oberfläche / Surface / Superficie**

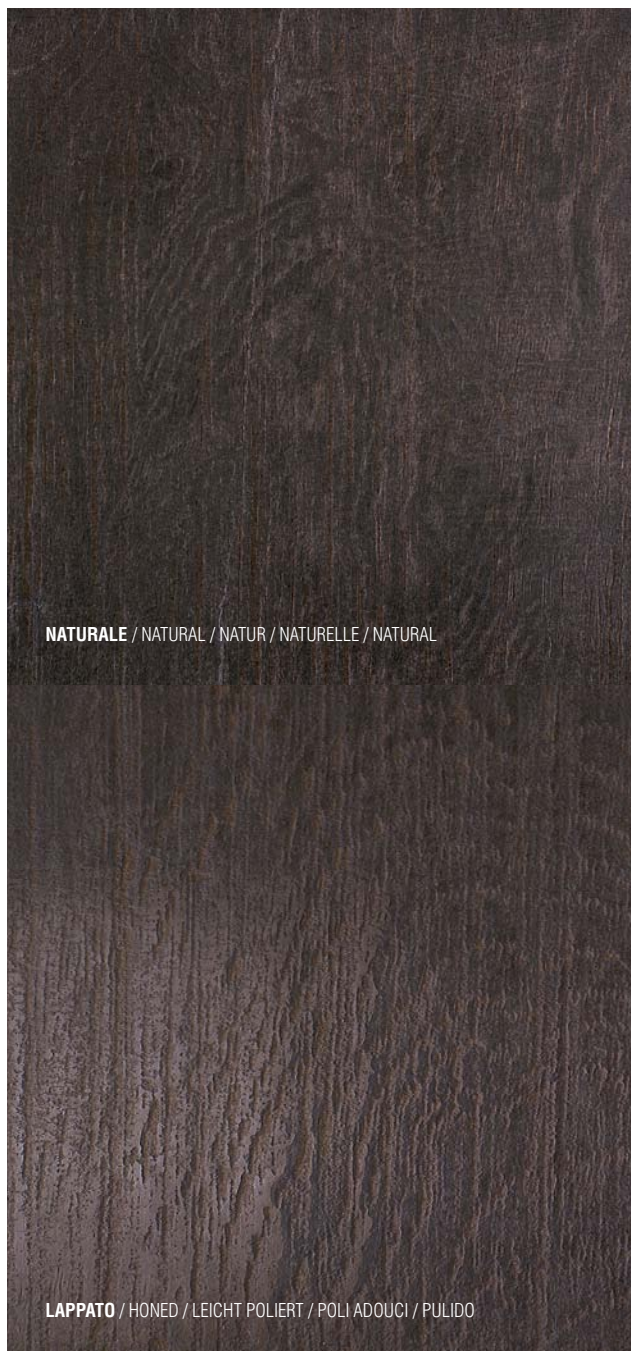

# LEGNOTECH

## Gres porcellanato colorato in massa EN 14411 Bla

Colorbody porcelain stoneware / Durghgefärbtes steinzeug / Grès cérame coloré dans le masse / Gres porcelánico coloreado en toda la masa



### NATURALE

NATURAL / NATUR / NATURELLE / NATURAL

### LAPPATO

HONED / LEICHT POLIERT  
POLI ADOUCI / PULIDO

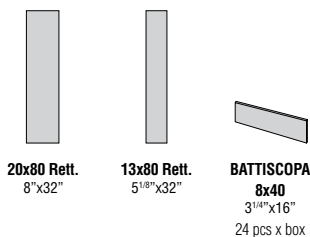

### NATURALE

NATURAL / NATUR / NATURELLE / NATURAL

	0040111	0040112	0040117
<b>Betulla</b>			
<b>Rovere</b>	0040141	0040142	0040147
<b>Noce</b>	0040121	0040122	0040127
<b>Wenghè</b>	0040131	0040132	0040137

### LAPPATO

HONED / LEICHT POLIERT / POLI ADOUCI / PULIDO

	0040113	0040114	-
<b>Betulla</b>			
<b>Rovere</b>	0040143	0040144	-
<b>Noce</b>	0040123	0040124	-
<b>Wenghè</b>	0040133	0040134	-

**Avvertenze per la posa: si consiglia la posa a correrre del materiale, sfalsando il lato più lungo per massimo 15 cm sulla lunghezza del pezzo adiacente. Utilizzare una fuga di minimo 2 mm.**

Attention when laying: we recommend laying in a brick pattern, staggering the slats so that the longer side is offset a maximum of 15 cm against its neighbour. Leave a minimum 2 mm gap between slats.

Hinweise für die Verlegung: Es wird die fortlaufende Verlegung des Materials empfohlen, mit Versetzung der Längsseite um maximal 15 cm zum anliegenden Teil. Eine Fuge von mindestens 2 mm vorsehen.

Avertissement pour la pose : une pose à l'anglaise du matériau est conseillée, en décalant le côté le plus long de 15 cm maximum sur la longueur de l'élément adjacent. Utiliser un joint d'au moins 2 mm.

Advertencia para la colocación: aconsejamos la colocación del material a junta partida, escalonando el lado más largo como máximo 15 cm. sobre la longitud de la pieza contigua. Utilícese una junta de 2 mm. como mínimo.

### Imballi / Packing / Verpackungen / Emballages / Embalajes

Formato	Pezzi/Sc.	Mq/Sc	Sc/Pal	Mq/Pal	Kg/Sc	Kg/Pal
Size	Pcs/Box	Sq.M/Box	Box/Pal	Sq.M/Pal	Kg/Box	Kg/Pal
Größe	Pcs/Ctn	Mq/Ctn	Ctn/Pal	Mq/Pal	Kg/Ctn	Kg/Pal
Format	Stck/Kart	Qm/Kart	Kart/Pal	Qm/Pal	Kg/Kart	Kg/Pal
Tamaño	Piezas/Caja	Mq/Caja	Caja/Pal	Mq/Pal	Kg/Caja	Kg/Pal
<b>20x80 Rett.</b>	<b>8</b>	<b>1,28</b>	<b>48</b>	<b>61,44</b>	<b>28,00</b>	<b>1291,20</b>
<b>13x80 Rett.</b>	<b>12</b>	<b>1,25</b>	<b>54</b>	<b>67,50</b>	<b>27,50</b>	<b>1458,00</b>

NF	UPECC	Classement			
		U	P	E	C
20x80 Nat.	U4	P3	E3	C2	S
20x80 Lapp.	U4	P3	E3	C2	S



**0040115** Listello Mix 3 Betulla Rett. Lapp. 13x80 - 5"x32"  
6 pcs x box



**0040125** Listello Mix 3 Noce Rett. Lapp. 13x80 - 5"x32"  
6 pcs x box



**0040145** Listello Mix 3 Rovere Rett. Lapp. 13x80 - 5"x32"  
6 pcs x box



**0040135** Listello Mix 3 Whenghé Rett. Lapp. 13x80 - 5"x32"  
6 pcs x box

Wenghè Rett. Lapp. 20x80  
Listello Mix 3 Wenghè Rett. Lapp. 13x80

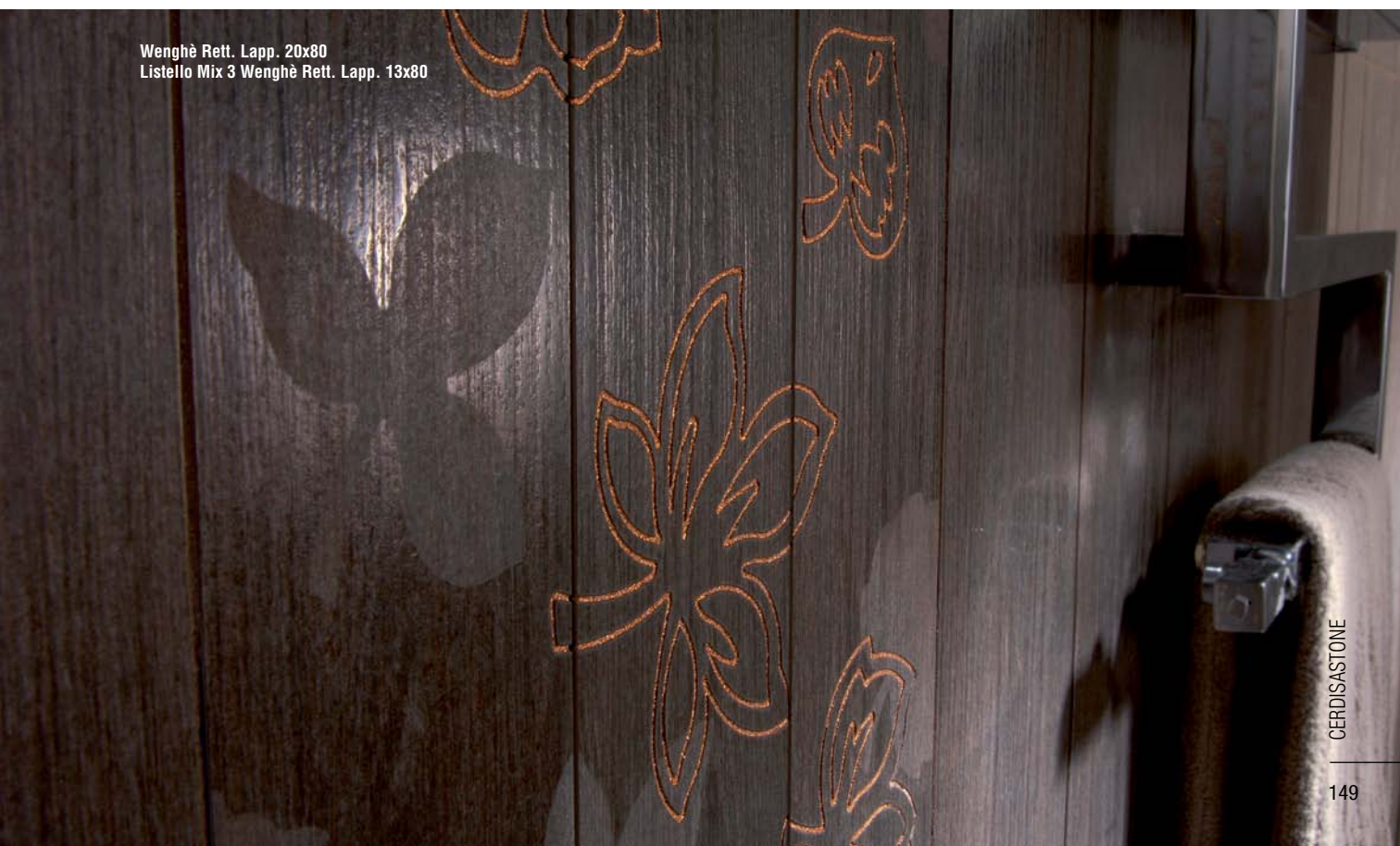



# NEOSTONE

**Gres porcellanato colorato in massa EN 14411 Bla**

Colorbody porcelain stoneware / Durghgefärbtes steinzeug / Grès cérame coloré dans la masse / Gres porcelánico coloreado en toda la masa



**Mosaico 3D Grigio 16,5x50**  
Grigio Nat. 50x100  
Grigio Grip 50x100 / 50x50 / 50x33,3 / 33,3x33,3



**Antracite Grip 50x100**



**Mosaico 3D Antracite 16,5x50**  
Avorio Nat. 50x50 / 33,3x50 / 33,3x33,3



**Formati / Sizes / Grösse / Format / Tamaño:**

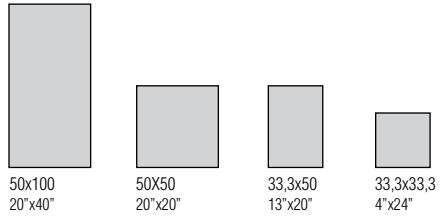

**Superfici / Surface / Oberfläche / Surface / Superficie**

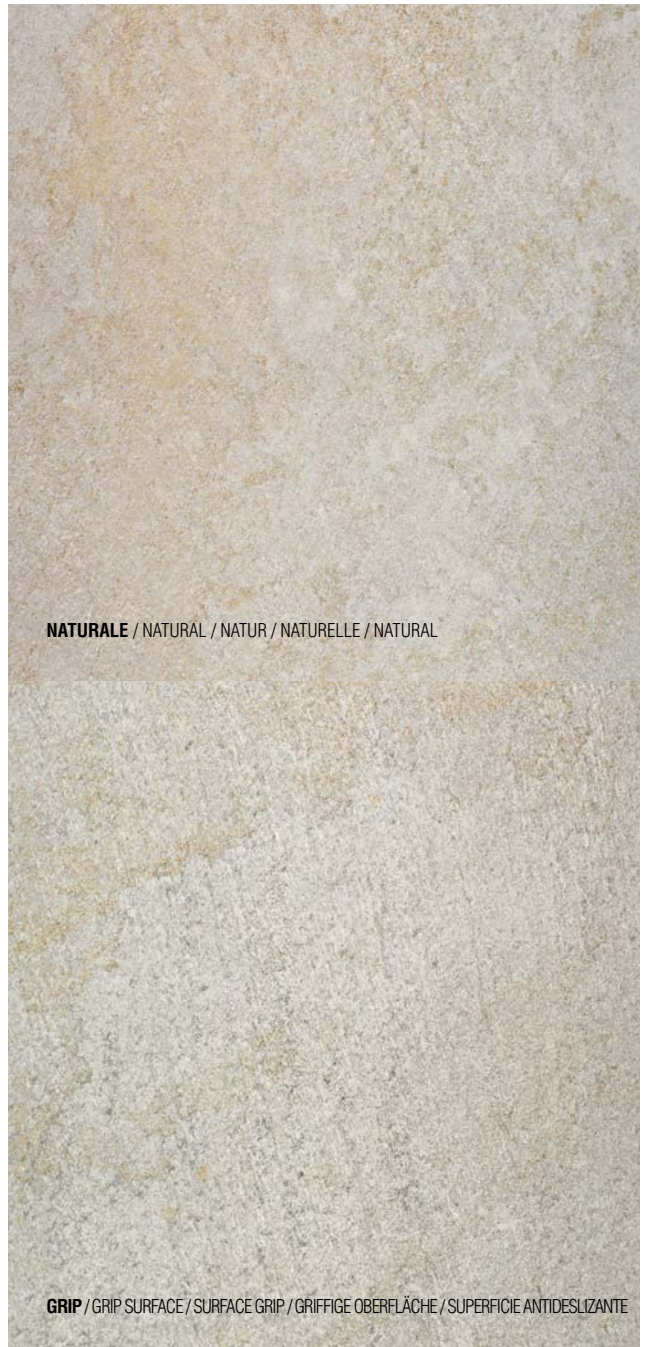

# NEOSTONE

**Gres porcellanato colorato in massa EN 14411 Bla**

Colorbody porcelain stoneware / Durghgefärbtes steinzeug / Grès cérame coloré dans le masse / Gres porcelánico coloreado en toda la masa





Mosaico 3D Antracite 16,5x50  
Antracite Nat. 50x50  
Antracite Nat. 33,3x50  
Antracite Nat. 33,3x33,3



Mosaico 3D Antracite 16,5x50

# NEOSTONE

## Gres porcellanato colorato in massa EN 14411 B1a

Colorbody porcelain stoneware / Durghgefärbtes steinzeug / Grès cérame coloré dans le masse / Gres porcelánico coloreado en toda la masa



PENDULUM TEST BS 7976 Grip > 36 dry / da 25 a 35 wet

ANSI A 137.1:2012  
Nat. R9 A  
Grip R11 A+B+C  
DCOF ≥ 0,42



Avorio

Grigio

Antracite



**NATURALE**  
NATURAL / NATUR / NATURELLE / NATURAL

**GRIP**  
GRIP SURFACE / SURFACE GRIP / GRIFFIGE OBERFLÄCHE / SUPERFICIE ANTIDESLIZANTE



**0025408** Mosaico 3D Avorio  
16,5x50 - 6 1/4"x20"  
2 pcs x box



**0025428** Mosaico 3D Grigio  
16,5x50 - 6 1/4"x20"  
2 pcs x box



**0025448** Mosaico 3D Antracite  
16,5x50 - 6 1/4"x20"  
2 pcs x box



**0025409** Mosaico Avorio  
33,3x33,3 - 13"x13"  
4 pcs x box



**0025429** Mosaico Grigio  
33,3x33,3 - 13"x13"  
4 pcs x box



**0025449** Mosaico Antracite  
33,3x33,3 - 13"x13"  
4 pcs x box

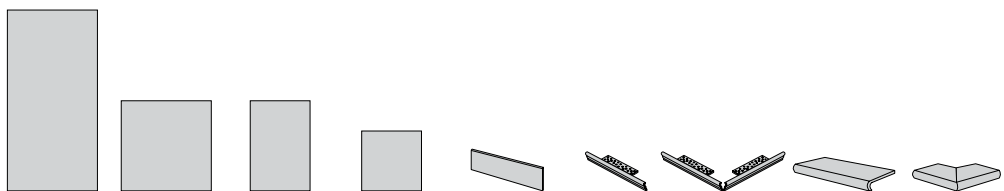

**50x100**  
20"x40"

**50x50**  
20"x20"

**33,3x50**  
13"x20"

**33,3x33,3**  
13"x13"

**BATTISCOPA**  
**9,5x50**  
3 7/8"x20"

20 pcs x box

**TORO**  
**5x33,3**  
2"x13"

4 pcs x box

**TORO ANG.**  
**5x33,3**  
2"x13"

2 pcs x box

**GRADONE**  
**16,5x30x4,5**  
6 3/4"x12"x1 7/8"

8 pcs x box

**GRADONE ANG.**  
**16,5x30x4,5**  
6 3/4"x12"x1 7/8"

4 pcs x box

## NATURALE

NATURAL / NATUR / NATURELLE / NATURAL

<b>Avorio</b>	<b>0025400</b>	<b>0025402</b>	<b>0025404</b>	<b>0025406</b>	<b>0025410</b>	<b>0025411</b>	<b>0025412</b>	-	-
<b>Grigio</b>	<b>0025420</b>	<b>0025422</b>	<b>0025424</b>	<b>0025426</b>	<b>0025430</b>	<b>0025431</b>	<b>0025432</b>	-	-
<b>Antracite</b>	<b>0025440</b>	<b>0025442</b>	<b>0025444</b>	<b>0025446</b>	<b>0025450</b>	<b>0025451</b>	<b>0025452</b>	-	-

## GRIP

GRIP SURFACE / SURFACE GRIP / GRIFFIGE OBERFLÄCHE / SUPERFICIE ANTIDESLIZANTE

<b>Avorio</b>	<b>0025401</b>	<b>0025403</b>	<b>0025405</b>	<b>0025407</b>	-	-	-	<b>0025413</b>	<b>0025414</b>
<b>Grigio</b>	<b>0025421</b>	<b>0025423</b>	<b>0025425</b>	<b>0025427</b>	-	-	-	<b>0025433</b>	<b>0025434</b>
<b>Antracite</b>	<b>0025441</b>	<b>0025443</b>	<b>0025445</b>	<b>0025447</b>	-	-	-	<b>0025453</b>	<b>0025454</b>

## Imballi / Packing / Verpackungen / Embalajes

Formato	Pezzi/Sc.	Mq/Sc	Sc/Pal	Mq/Pal	Kg/Sc	Kg/Pal
Size	Pcs/Box	Sq.M/Box	Box/Pal	Sq.M/Pal	Kg/Box	Kg/Pal
Grösse	Pcs/Ctn	Mq/Ctn	Ctn/Pal	Mq/Pal	Kg/Ctn	Kg/Pal
Format	Stok/Kart	Qm/Kart	Kart/Pal	Qm/Pal	Kg/Kart	Kg/Pal
Tamaño	Piezas/Caja	Mq/Caja	Caja/Pal	Mq/Pal	Kg/Caja	Kg/Pal
<b>50x100</b>	<b>3</b>	<b>1,50</b>	<b>30</b>	<b>45,00</b>	<b>37,00</b>	<b>1119,0</b>
<b>50x50</b>	<b>6</b>	<b>1,50</b>	<b>24</b>	<b>36,00</b>	<b>34,00</b>	<b>819,0</b>
<b>33,3x50</b>	<b>6</b>	<b>1,00</b>	<b>40</b>	<b>48,00</b>	<b>24,00</b>	<b>960,0</b>
<b>33,3x33,3</b>	<b>10</b>	<b>1,11</b>	<b>46</b>	<b>51,06</b>	<b>24,45</b>	<b>1124,7</b>

# NEOSTONE

## Gres porcellanato colorato in massa EN 14411 Bia

Colorbody porcelain stoneware / Durghgefärbtes steinzeug / Grès cérame coloré dans la masse / Gres porcelánico coloreado en toda la masa



PENDULUM TEST BS 7976 Grip > 36 dry / da 25 a 35 wet

ANSI A 137.1:2012  
Nat. R9 A  
Grip R11 A+B+C  
DCOF ≥ 0,42



AVORIO

GRIGIO

	33,3x33,3 cm	33,3x50 cm	50x50 cm
N° pezzi per modulo N° pieces for module	2	2	2
% mq	21,03%	31,57%	47,40%

Modulo 3A

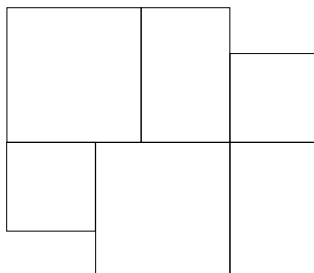

	33,3x33,3 cm	33,3x50 cm	50x50 cm	50x100 cm
N° pezzi per modulo N° pieces for module	1	2	1	1
% mq	9,29%	27,88%	20,94%	41,88%

	Naturale	Grip
Avorio	NEN 3A AV	NEG 3A AV
Grigio	NEN 3A GR	NEG 3A GR
Antracite	NEN 3A AN	NEG 3A AN

	Naturale	Grip
Avorio	NEN 4A AV	NEG 4A AV
Grigio	NEN 4A GR	NEG 4A GR
Antracite	NEN 4A AN	NEG 4A AN

Si raccomanda la posa con fuga 4 mm / Laying with joints of 4 mm is strongly recommended / Es wird die Verlegung mit einer Fugenbreite von 4 mm empfohlen / Pose avec joint de 4 mm recommandée / En el solado se aconseja dejar juntas de 4 mm

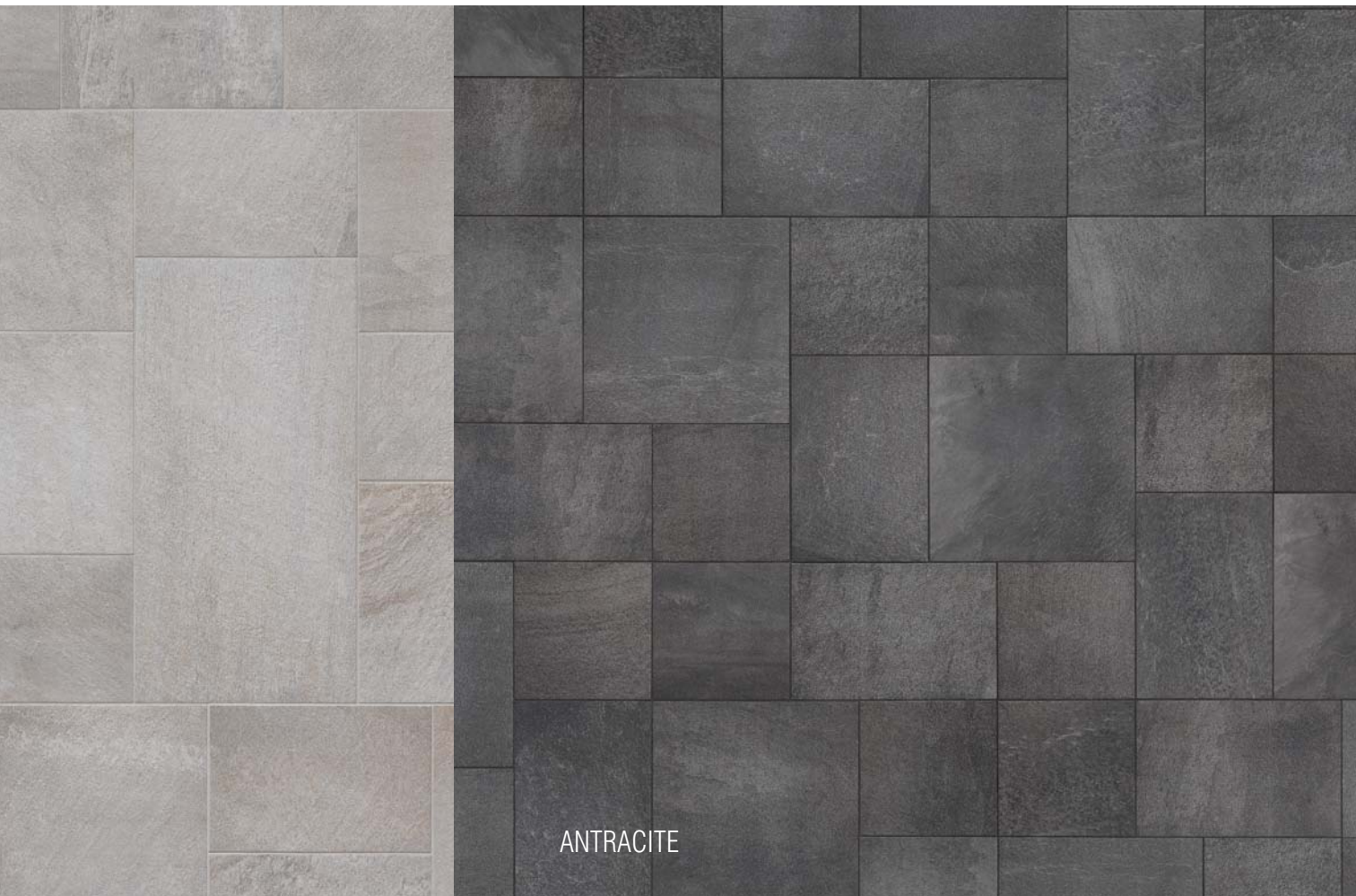

ANTRACITE

Modulo 4A

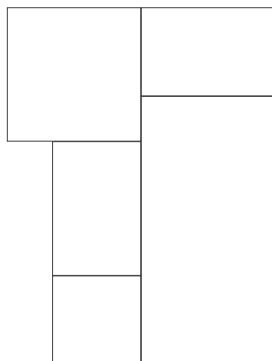

	33,3x33,3 cm	33,3x50 cm	50x50 cm
N° pezzi per modulo N° pieces for module	3	2	1
% mq	36,33%	36,37%	27,30%

	Naturale	Grip
Avorio	NEN 3B AV	NEG 3B AV
Grigio	NEN 3B GR	NEG 3B GR
Antracite	NEN 3B AN	NEG 3B AN

Modulo 3B

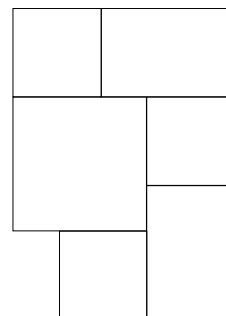



# REFLEX DESIGN

**Gres porcellanato colorato in massa EN 14411 Bla**

Colorbody porcelain stoneware / Durghgefärbtes steinzeug / Grès cérame coloré dans le masse / Gres porcelánico coloreado en toda la masa



Silver Lapp. Rett. 49,5x49,5

50x50 / 49,5x49,5 - 20"x20"

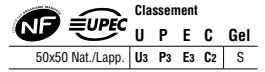

**Diamond**

**Silver**

Formati / Sizes / Grösse / Format / Tamaño:

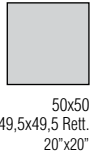

**NATURALE**  
NATURAL / NATUR / NATURELLE / NATURAL

**LAPPATO**  
HONED / LEICHT POLIERT / POLI ADOUCI / PULIDO

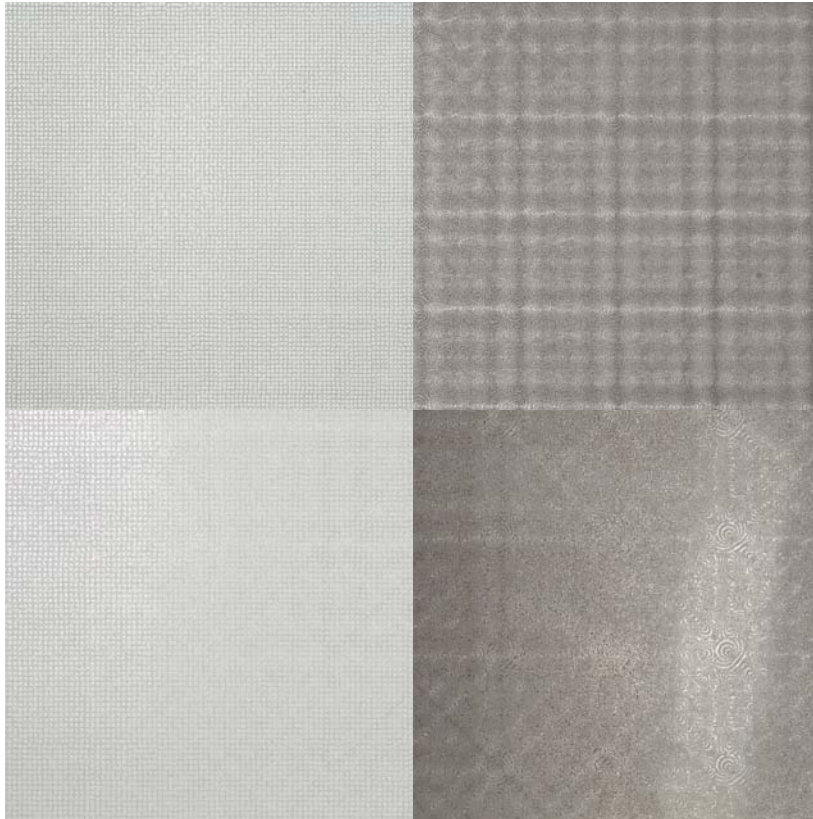

**50x50**  
20"x20"

**49,5x49,5 Rett.**  
20"x20"

**BATTISCOPA**  
**9,5x50**  
3"68"x20"  
16 pcs x box

**NATURALE**

NATURAL / NATUR / NATURELLE / NATURAL

<b>Diamond</b>	<b>0025150</b>	<b>0025170</b>	<b>0025153</b>
<b>Silver</b>	<b>0025165</b>	<b>0025185</b>	<b>0025168</b>

**LAPPATO**

HONED / LEICHT POLIERT / POLI ADOUCI / PULIDO

<b>Diamond</b>	-	<b>0025151</b>	-
<b>Silver</b>	-	<b>0025166</b>	-



Imballi / Packing / Verpackungen / Emballages / Embalajes

Formato	Pezzi/Sc.	Mq/Sc	Sc/Pal	Mq/Pal	Kg/Sc	Kg/Pal
Size	Pcs/Box	Sq.M/Box	Box/Pal	Sq.M/Pal	Kg/Box	Kg/Pal
Grösse	Pcs/Ctn	Mq/Ctn	Ctn/Pal	Mq/Pal	Kg/Ctn	Kg/Pal
Format	Stck/Kart	Qm/Kart	Kart/Pal	Qm/Pal	Kg/Kart	Kg/Pal
Tamaño	Piezas/Caja	Mq/Caja	Caja/Pal	Mq/Pal	Kg/Caja	Kg/Pal
<b>50x50</b>	<b>6</b>	<b>1,50</b>	<b>24</b>	<b>36,00</b>	<b>32,80</b>	<b>787,2</b>
<b>49,5x49,5</b>	<b>6</b>	<b>1,47</b>	<b>24</b>	<b>35,28</b>	<b>32,15</b>	<b>771,6</b>

# SATURNIA

**Gres porcellanato smaltato Bla EN 14411**

Glazed Porcelain Stoneware / Glasiertes Feinsteinzeug / Grès cérame émaillé / Gres porcelánico esmaltado





**Silver Rett. 50x50 / 8,1x16,4**

**Formati / Sizes / Grösse / Format / Tamaño:**



50x50  
50x50 Rett.  
20"x20"



33,3x33,3  
33,3x33,3 Rett.  
13"x13"



8,1x16,4 Rett.  
3<sup>1/4</sup>"x6<sup>3/4</sup>"

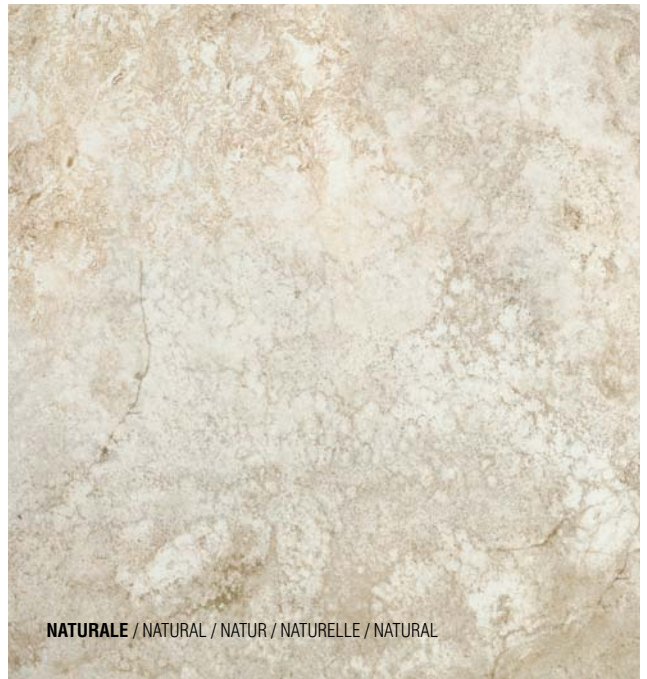

**NATURALE / NATURAL / NATUR / NATURELLE / NATURAL**

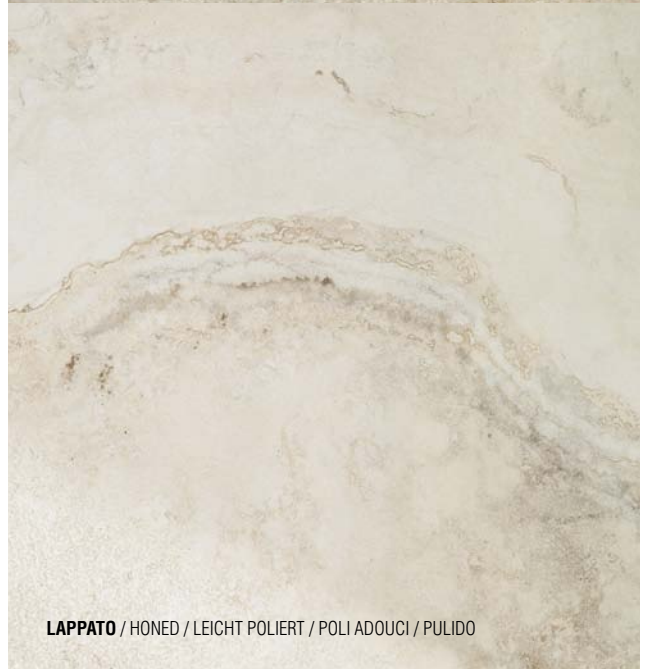

**LAPPATO / HONED / LEICHT POLIERT / POLI ADOUCI / PULIDO**



**Chiaro Rett. 50x50  
Mattoncino Mix 33x33**

## Gres porcellanato smaltato Bla EN 14411

Glazed Porcelain Stoneware / Glasiertes Feinsteinzeug / Grès cérame émaillé / Gres porcelánico esmaltado



Chiaro

Silver

Classico

Noce

NATURALE  
NATURAL / NATUR / NATURELLE / NATURAL

LAPPATO  
HONED / LEICHT POLIERT / POLI ADOUCI / PULIDO



50x50  
20"x20"



50x50 Rett.  
20"x20"



33,3x33,3  
13"x13"



33,3x33,3 Rett.  
13"x13"



8,1x16,4 Rett.  
3 1/4"x6 3/4"



BATTISCOPA  
8x33,3  
3 1/4"x13"  
44 pcs x box

### NATURALE

NATURAL / NATUR / NATURELLE / NATURAL

	Chiaro	Silver	Classico	Noce
50x50	0025220	0025221	0025223	0025224
50x50 Rett.	0025260	0025261	0025263	0025264
33,3x33,3	0025240	0025241	0025243	0025244
33,3x33,3 Rett.	0025200	0025201	0025203	0025204
8,1x16,4 Rett.				0025206
BATTISCOPA				0025207

### LAPPATO

HONED / LEICHT POLIERT / POLI ADOUCI / PULIDO

	Chiaro	Silver	Classico	Noce
50x50	-	0025222	-	-
50x50 Rett.	-	0025262	-	-
33,3x33,3	-	0025242	-	-
33,3x33,3 Rett.	-	0025202	-	-



0025208 Mattoncino Mix  
33,3x33,3 - 13"x13"  
4 pcs x box

### Imballi / Packing / Verpackungen / Emballages / Embalajes

Formato	Pezzi/Sc.	Mq/Sc	Sc/Pal	Mq/Pal	Kg/Sc	Kg/Pal
Size	Pcs/Box	Sq./M/Box	Box/Pal	Sq./M/Pal	Kg/Box	Kg/Pal
Größe	Pcs/Ctn	Mq/Ctn	Ctn/Pal	Mq/Pal	Kg/Ctn	Kg/Pal
Formato	Stck/Kart	Qm/Kart	Kart/Pal	Qm/Pal	Kg/Kart	Kg/Pal
Tamaño	Piezas/Caja	Mq/Caja	Caja/Pal	Mq/Pal	Kg/Caja	Kg/Pal
50x50	6	1,50	24	36,00	33,00	792,00
50x50 Rett./Lapp.	6	1,50	24	36,00	31,70	760,80
33,3x33,3	12	1,33	46	61,18	26,60	1223,60
33,3x33,3 Rett.	12	1,33	46	61,18	25,90	1191,40
8,1x16,4	76	1,01	36	28,28	22,62	633,36



# TIVOLI

**Gres porcellanato smaltato Bla EN 14411**

Glazed Porcelain Stoneware / Glasiertes Feinsteinzeug / Grès cérame émaillé / Gres porcelánico esmaltado





**Formati / Sizes / Grösse / Format / Tamaño:**



50x100 Rett.  
20"x40"



25x100 Rett.  
10"x40"



50x50 Rett.  
20"x20"

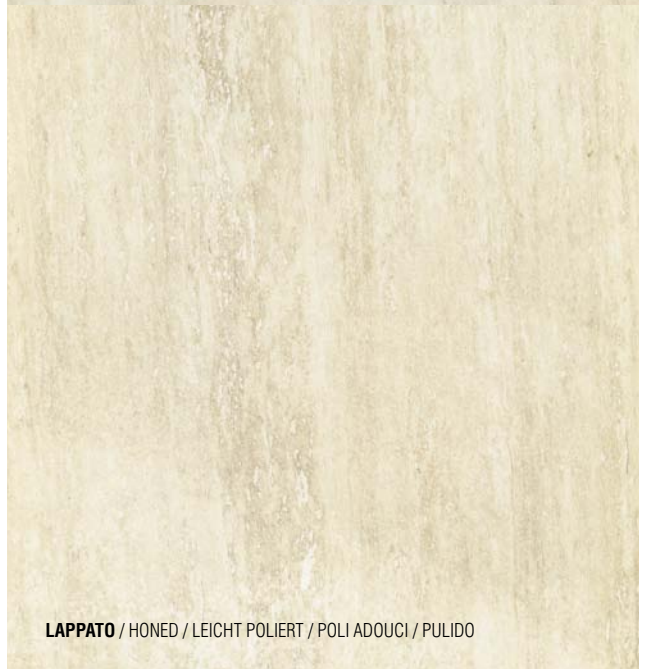
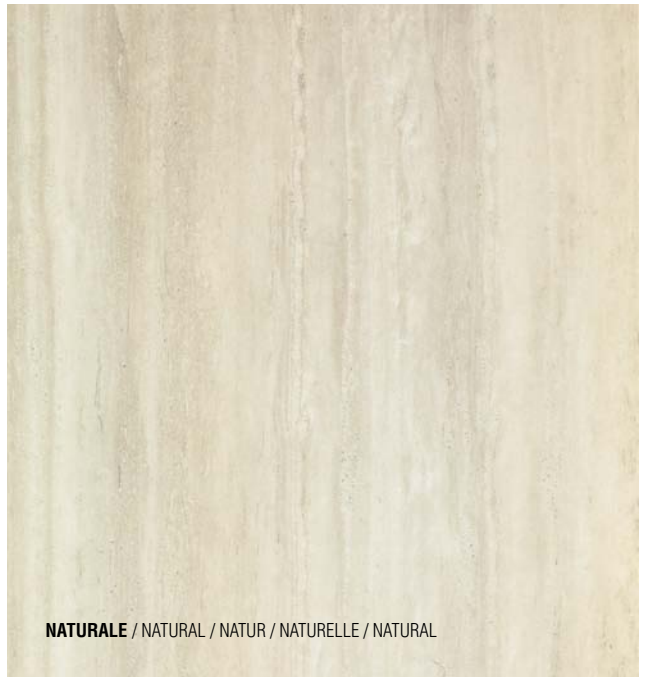



# TIVOLI

## Gres porcellanato smaltato Bla EN 14411

Glazed Porcelain Stoneware / Glasiertes Feinsteinzeug / Grès cérame émaillé / Gres porcelánico esmaltado



Avorio

Beige

Grigio

NATURALE  
NATURAL / NATUR / NATURELLE / NATURAL

LAPPATO  
HONED / LEICHT POLIERT  
POLI ADOUCI / PULIDO



50x100 Rett.  
20"x40"



25x100 Rett.  
10"x40"



50x50 Rett.  
20"x20"



BATTISCOPA  
9,5x50  
3<sup>7/8</sup>"x20"  
20 pcs x box



ALZATA LUX  
15x25  
6"x10"  
6 pcs x box



ALZATA MATT  
15x25  
6"x10"  
6 pcs x box



TORELLO LUX  
5x25  
2"x10"  
6 pcs x box



TORELLO MATT  
5x25  
2"x10"  
6 pcs x box

### NATURALE

NATURAL / NATUR / NATURELLE / NATURAL

Avorio	0025301	0025303	0025305	0025367	-	0025312	-	0025311
Beige	0025321	0025323	0025325	0025368	-	0025352	-	0025351
Grigio	0025341	0025343	0025345	0025366	-	0025332	-	0025331

### LAPPATO

HONED / LEICHT POLIERT / POLI ADOUCI / PULIDO

Avorio	0025302	0025304	0025306	-	0025309	-	0025308	-
Beige	0025322	0025324	0025326	-	0025349	-	0025348	-
Grigio	0025342	0025344	0025346	-	0025329	-	0025328	-



25x100  
10"x40"

**RIFLESSI**

Avorio	0025313
Beige	0025333
Grigio	0025353

**RIFLESSI LAPPATO**

Avorio	0025314
Beige	0025334
Grigio	0025354

**Imballi / Packing / Verpackungen / Emballages / Embalajes**

Formato	Pezzi/Sc.	Mq/Sc	Sc/Pal	Mq/Pal	Kg/Sc	Kg/Pal
Size	Pcs/Box	Sq.M/Box	Box/Pal	Sq.M/Pal	Kg/Box	Kg/Pal
Größe	Pcs/Ctn	Mq/Ctn	Ctn/Pal	Mq/Pal	Kg/Ctn	Kg/Pal
Format	Stck/Kart	Qm/Kart	Kart/Pal	Qm/Pal	Kg/Kart	Kg/Pal
Tamaño	Piezas/Caja	Mq/Caja	Caja/Pal	Mq/Pal	Kg/Caja	Kg/Pal
50x100	3	1,50	30	40,50	33,00	990,00
25x100	6	1,50	32	48,00	33,00	1056,00
50x50	6	1,50	24	36,00	34,00	720,00

# TIVOLI

## Gres porcellanato smaltato Bla EN 14411

Glazed Porcelain Stoneware / Glasiertes Feinsteinzeug / Grès cérame émaillé / Gres porcelánico esmaltado



**0025307** Boiserie AV Rett.  
25x100 - 10"x40"  
2 pcs x box



**0025347** Boiserie BG Rett.  
25x100 - 10"x40"  
2 pcs x box



**0025327** Boiserie GR Rett.  
25x100 - 10"x40"  
2 pcs x box

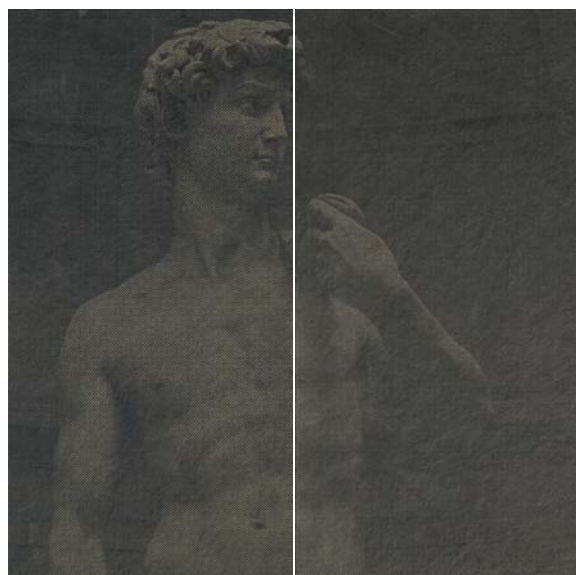

**0025360** Pannello David Vers. Calda 100x100 (comp. 2 pcs) - 40"x40"  
1 comp. x box

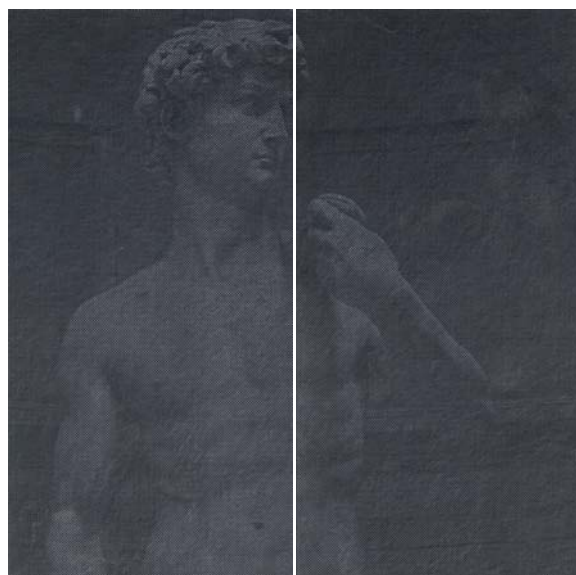

**0025362** Pannello David Vers. Fredda 100x100 (comp. 2 pcs) - 40"x40"  
1 comp. x box



**0025361** Listello Greca Vers. Calda  
15x50 - 6"x20"  
2 pcs x box



**0025363** Listello Greca Vers. Fredda  
15x50 - 6"x20"  
2 pcs x box



**0025364** Rosone Beige 100x100 (comp. 4 pcs) - 40"x40"  
1 comp. x box

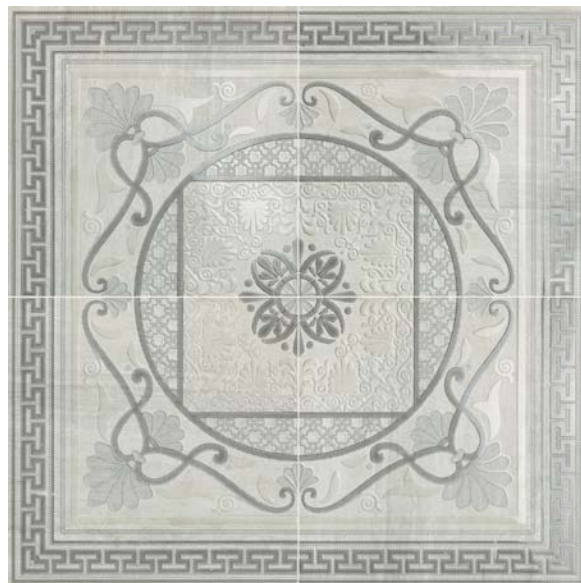

**0025365** Rosone Grigio 100x100 (comp. 4 pcs) - 40"x40"  
1 comp. x box



**0025369** Fascia Vers. Calda  
16,5x50 - 6 1/4"x20"  
2 pcs x box



**0025371** Fascia Vers. Calda  
16,5x16,5 - 6 1/4"x6 1/4"  
4 pcs x box



**0025370** Fascia Vers. Fredda  
16,5x50 - 6 1/4"x20"  
2 pcs x box



**0025372** Fascia Vers. Fredda  
16,5x16,5 - 6 1/4"x6 1/4"  
4 pcs x box

**Rosone Grigio 100x100**  
**Grigio Rett. Lapp. 50x50**



# VERSILIA ZEBRINO

Gres porcellanato smaltato Bla EN 14411

Glazed Porcelain Stoneware / Glasiertes Feinsteinzeug / Grès cérame émaillé / Gres porcelánico esmaltado





**Formati / Sizes / Grösse / Format / Tamaño:**



50x100 Rett.  
20"x40"



25x100 Rett.  
10"x40"



50x50 Rett.  
20"x20"

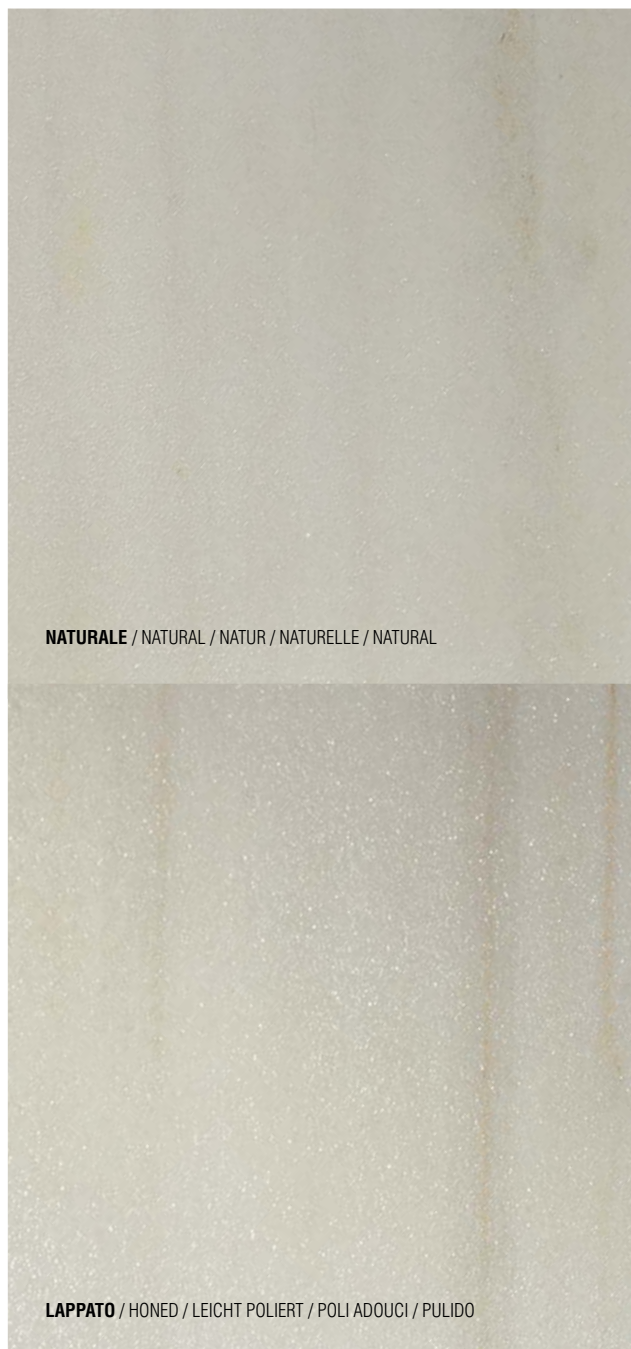

# VERSILIA ZEBRINO

Gres porcellanato smaltato Bla EN 14411

Glazed Porcelain Stoneware / Glasiertes Feinsteinzeug / Grès cérame émaillé / Gres porcelánico esmaltado



Zebrino



NATURALE  
NATURAL / NATUR / NATURELLE / NATURAL

Zebrino



LAPPATO  
HONED / LEICHT POLIERT / POLI ADOUCI / PULIDO



50x100  
20"x40"



25x100  
10"x40"



50x50  
20"x20"

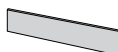

BATTISCOPA  
9,5x50  
3<sup>7/8</sup>"x20"  
20 pcs x box



ALZATA  
15x15  
6"x10"  
6 pcs x box



ANGOLO ALZATA  
2x15  
7/8"x6"  
4 pcs x box



TORELLO  
5x25  
2"x10"  
6 pcs x box



ANGOLO TORELLO  
2x5  
7/8"x2"  
4 pcs x box

## NATURALE

NATURAL / NATUR / NATURELLE / NATURAL

Zebrino	0025522	0025524	0025526	0025527	0025534	0025535	0025532	0025533
---------	---------	---------	---------	---------	---------	---------	---------	---------

## LAPPATO

HONED / LEICHT POLIERT / POLI ADOUCI / PULIDO

Zebrino	0025521	0025523	0025525	-	-	-	-	-
---------	---------	---------	---------	---	---	---	---	---

## Imballi / Packing / Verpackungen / Emballages / Embalajes

Formato	Pezzi/Sc.	Mq/Sc	Sc/Pal	Mq/Pal	Kg/Sc	Kg/Pal
Size	Pcs/Box	Sq.M/Box	Box/Pal	Sq.M/Pal	Kg/Box	Kg/Pal
Grösse	Pcs/Ctn	Mq/Ctn	Ctn/Pal	Mq/Pal	Kg/Ctn	Kg/Pal
Format	Stck/Kart	Qm/Kart	Kart/Pal	Qm/Pal	Kg/Kart	Kg/Pal
Tamaño	Piezas/Caja	Mq/Caja	Caja/Pal	Mq/Pal	Kg/Caja	Kg/Pal
50x100	3	1,50	30	49,50	33,0	990,0
25x100	6	1,50	32	48,00	33,0	1056,0
50x50	6	1,50	24	36,00	34,1	818,4



**0025529** Rosone Zebrino Rett. Lapp.  
50x100 - 10"x40"  
1 pcs x box



**0025530** Trama Zebrino Rett. Lapp.  
25x100 - 10"x40"  
4 pcs x box



**0025528** Mosaico Zebrino Rett. Lapp.  
33,33x33,3 - 13"x13"  
4 pcs x box



**0025537** Pannello Rosone Zebrino Rett. Lapp. 100x100 (comp. 4 pcs) - 40"x40"  
1 comp. x box



**0025531** Pannello Muse Zebrino Orizzontale Rett. Lapp. 100x100 (comp. 4 pcs) - 40"x40"  
1 comp. x box



**0025538** Listello Zebrino Rett. Lapp.  
12,5x50 - 5"x20"  
2 pcs x box



**0025539** Angolo Listello Zebrino Rett. Lapp.  
12,5x12,5 - 5"x5"  
4 pcs x box



# VERSILIA CARRARA

Gres porcellanato smaltato Bla EN 14411

Glazed Porcelain Stoneware / Glasiertes Feinsteinzeug / Grès cérame émaillé / Gres porcelánico esmaltado





**Formati / Sizes / Grösse / Format / Tamaño:**



50x100 Rett.  
20"x40"



25x100 Rett.  
10"x40"



50x50 Rett.  
20"x20"

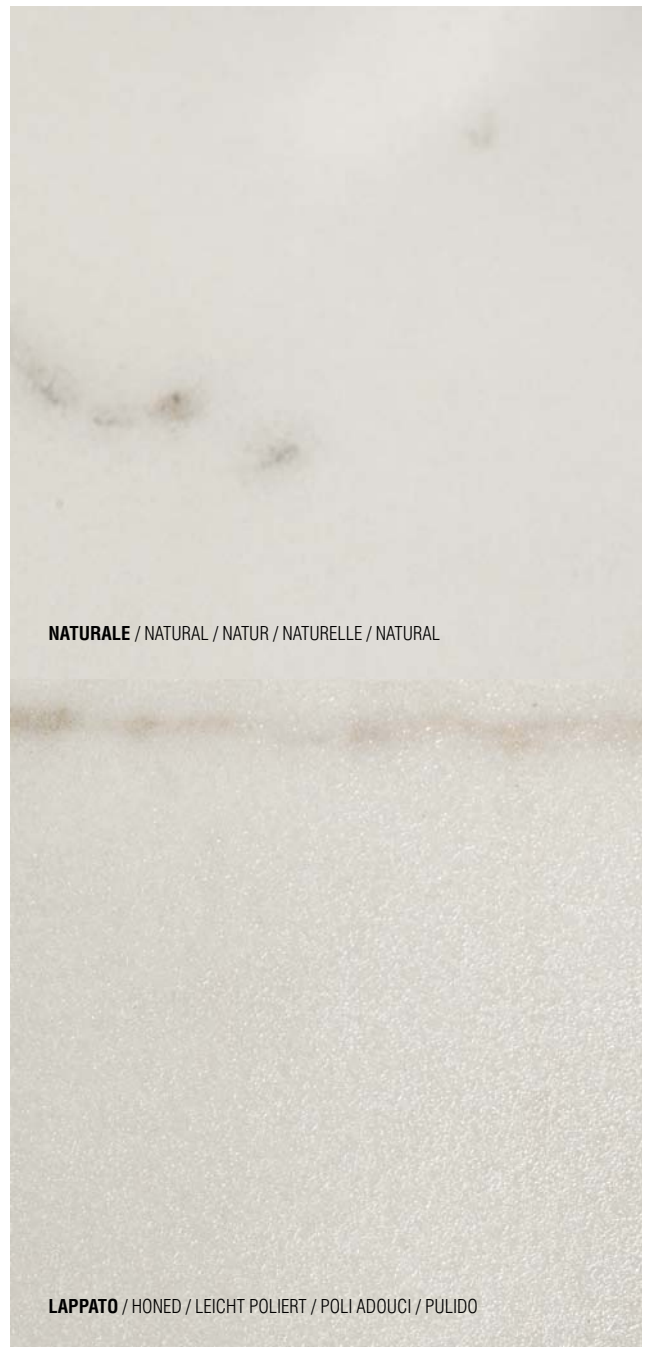

# VERSILIA CARRARA

Gres porcellanato smaltato Bla EN 14411

Glazed Porcelain Stoneware / Glasiertes Feinsteinzeug / Grès cérame émaillé / Gres porcelánico esmaltado



Carrara



NATURALE  
NATURAL / NATUR / NATURELLE / NATURAL

Carrara



LAPPATO  
HONED / LEICHT POLIERT / POLI ADOUCI / PULIDO



50x100  
20"x40"



25x100  
10"x40"



50x50  
20"x20"

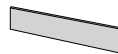

BATTISCOPA  
9,5x50  
3<sup>7/8</sup>"x20"  
20 pcs x box



ALZATA  
15x15  
6"x10"  
6 pcs x box



ANGOLO ALZATA  
2x15  
7/8"x6"  
4 pcs x box



TORELLO  
5x25  
2"x10"  
6 pcs x box



ANGOLO TORELLO  
2x5  
7/8"x2"  
4 pcs x box

## NATURALE

NATURAL / NATUR / NATURELLE / NATURAL

Carrara	0025502	0025504	0025506	0025507	0025514	0025515	0025512	0025513
---------	---------	---------	---------	---------	---------	---------	---------	---------

## LAPPATO

HONED / LEICHT POLIERT / POLI ADOUCI / PULIDO

Carrara	0025501	0025503	0025505	-	-	-	-	-
---------	---------	---------	---------	---	---	---	---	---

## Imballi / Packing / Verpackungen / Emballages / Embalajes

Formato	Pezzi/Sc.	Mq/Sc	Sc/Pal	Mq/Pal	Kg/Sc	Kg/Pal
Size	Pcs/Box	Sq.M/Box	Box/Pal	Sq.M/Pal	Kg/Box	Kg/Pal
Grösse	Pcs/Ctn	Mq/Ctn	Ctn/Pal	Mq/Pal	Kg/Ctn	Kg/Pal
Format	Stck/Kart	Qm/Kart	Kart/Pal	Qm/Pal	Kg/Kart	Kg/Pal
Tamaño	Piezas/Caja	Mq/Caja	Caja/Pal	Mq/Pal	Kg/Caja	Kg/Pal
50x100	3	1,50	30	49,50	33,0	990,0
25x100	6	1,50	32	48,00	33,0	1056,0
50x50	6	1,50	24	36,00	34,1	818,4



**0025509** Rosone Carrara Rett. Lapp.  
50x100 - 10"x40"  
1 pcs x box



**0025510** Trama Carrara Rett. Lapp.  
25x100 - 10"x40"  
4 pcs x box

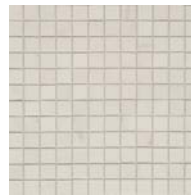

**0025508** Mosaico Carrara Rett. Lapp.  
33,33x33,3 - 13"x13"  
4 pcs x box



**0025516** Pannello Muse Carrara Verticale Rett. Lapp. 100x100 (comp. 4 pcs) - 40"x40"  
1 comp. x box



**0025511** Pannello Muse Carrara Orrizzontale Rett. Lapp. 100x100 (comp. 4 pcs) - 40"x40"  
1 comp. x box

# YESTONE

Gres porcellanato colorato in massa EN 14411 Bla

Colorbody porcelain stoneware / Durghgefärbtes steinzeug / Grès cérame coloré dans le masse / Gres porcelánico coloreado en toda la masa



Bronze 50x50



Grey-Silver 50x50



Cream 50x50  
Bronze 50x50

50x50 - 20"x20"



NATURALE / NATURAL / NATUR / NATURELLE / NATURAL



**0025000** Grey - Silver 50x50

**0025003** Black 50x50

**0025002** Cream 50x50

**0025001** Bronze 50x50



**0025023** Mosaico Grey - Silver Rett.  
24,6x49,5 - 10"x20"  
5 pcs x box



**0025038** Mosaico Black Rett.  
24,6x49,5 - 10"x20"  
5 pcs x box



**0025033** Mosaico Cream Rett.  
24,6x49,5 - 10"x20"  
5 pcs x box



**0025028** Mosaico Bronze Rett.  
24,6x49,5 - 10"x20"  
5 pcs x box

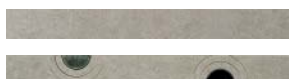

**0025022** Listello Mix Luna Grey - Silver  
5x49,5 - 2"x20"  
6 pcs x box (4 riposo + 2 listelli)



**0025037** Listello Mix Luna Black  
5x49,5 - 2"x20"  
6 pcs x box (4 riposo + 2 listelli)



**0025032** Listello Mix Luna Cream  
5x49,5 - 2"x20"  
6 pcs x box (4 riposo + 2 listelli)



**0025027** Listello Mix Luna Bronze  
5x49,5 - 2"x20"  
6 pcs x box (4 riposo + 2 listelli)



**0025008** Bacchetta Moon 1,5x49,5 - 3/4"x20"  
6 pcs x box



**0025009** Bacchetta Sun 1,5x49,5 - 3/4"x20"  
6 pcs x box



**0025029** Listello Universale  
5x49,5 - 2"x20"  
6 pcs x box

**Pezzi speciali / Special trims / Sonderstücke / Pièces spéciales / Piezas especiales**



**BATTISCOPIA**  
**9,5x50** - 3/8"x20"  
20 pcs x box

Grey - Silver	<b>0025004</b>
Black	<b>0025007</b>
Cream	<b>0025006</b>
Bronze	<b>0025005</b>

**Imballi / Packing / Verpackungen / Emballages / Embalajes**

Formato	Pezzi/Sc.	Mq/Sc	Sc/Pal	Mq/Pal	Kg/Sc	Kg/Pal
Size	Pcs/Box	Sq./M/Box	Box/Pal	Sq./M/Pal	Kg/Box	Kg/Pal
Größe	Pcs/Ctn	Mq/Ctn	Ctn/Pal	Mq/Pal	Kg/Ctn	Kg/Pal
Format	Stck/Kart	Qm/Kart	Kart/Pal	Qm/Pal	Kg/Kart	Kg/Pal
Tamaño	Piezas/Caja	Mq/Caja	Caja/Pal	Mq/Pal	Kg/Caja	Kg/Pal
<b>50x50</b>	<b>6</b>	<b>1,50</b>	<b>24</b>	<b>36,00</b>	<b>33,80</b>	<b>811,2</b>
<b>24,6x49,5</b>	<b>5</b>	<b>0,61</b>	<b>33</b>	<b>20,10</b>	<b>15,40</b>	<b>508,2</b>





**CERDISAWHITE**



# GLITTER

Rivestimento in pasta bianca rettificato BIII EN 14411 / White clay wall tiles rectified / Weisscherbige wandfliesen kalibriert  
Revêtement mural en pâte blanche rectifiée / Revestimientos en pasta blanca rectificado





White 32x75  
 Antracite 32x75  
 Decoro Creative WH-AN 32x75  
 White 32x32



White 32x75  
 Decoro Soft WH-AN 32x75  
 Listello Soft WH-AN 15x75  
 Antracite 32x32



White 32x75  
 Decoro Soft WH-AN 32x75  
 Listello Soft WH-AN 15x75

# GLITTER

Rivestimento in pasta bianca rettificato BIII EN 14411 / White clay wall tiles rectified / Weisscherbige wandfliesen kalibriert  
 Revêtement mural en pâte blanche rectifiée / Revestimientos en pasta blanca rectificado



**0003711** White Rett. 32x75



**0003716** Antracite Rett. 32x75



**0003712** Ivory Rett. 32x75



**0003713** Taupe Rett. 32x75



**0003735** Decoro Soft WH-AN Rett.  
 32x75 - 12%<sup>6</sup>x30"  
 2 pcs x box



**0003731** Listello Soft WH-AN Rett.  
 15x75 - 6"x30"  
 4 pcs x box



**0003734** Decoro Soft IV-TA Rett.  
 32x75 - 12%<sup>6</sup>x30"  
 2 pcs x box



**0003730** Listello Soft IV-TA Rett.  
 15x75 - 6"x30"  
 4 pcs x box



**0003739** Decoro Creative WH-AN Rett. 32x75 - 12%<sup>6</sup>x30"  
 2 pcs x box



**0003738** Decoro Creative IV-TA Rett. 32x75 - 12%<sup>6</sup>x30"  
 2 pcs x box



**0003753** Listello Damascato WHI  
7,5x32 - 3"x12<sup>5/8</sup>"  
4 pcs x box



**0003752** Listello Damascato ANT  
7,5x32 - 3"x12<sup>5/8</sup>"  
4 pcs x box



**0003743** Listello Damascato WHI  
7,5x75 - 3"x30"  
2 pcs x box



**0003742** Listello Damascato ANT  
7,5x75 - 3"x30"  
2 pcs x box



**0003750** Listello Damascato TAU  
7,5x32 - 3"x12<sup>5/8</sup>"  
4 pcs x box



**0003751** Listello Damascato TAB  
7,5x32 - 3"x12<sup>5/8</sup>"  
4 pcs x box



**0003740** Listello Damascato TAU  
7,5x75 - 3"x30"  
2 pcs x box



**0003741** Listello Damascato TAB  
7,5x75 - 3"x30"  
2 pcs x box

**PAVIMENTI COORDINATI LIFE 32x32 - 12<sup>5/8</sup>"x12<sup>5/8</sup>"** / COORDINATED FLOOR TILES / KOORDINIERTE BODENFLIESEN / SOLS COORDONNÉS / PAVIMENTOS COORDINADOS

**Gres porcellanato smaltato EN 14411 B1a** / Glazed porcelain stoneware / Glasiertes Steinzeug / Grès porcelainé émaillé / Gres porcelánico esmaltado



**0003721** White  
33x33 - 12<sup>5/8</sup>"x12<sup>5/8</sup>"



**0003726** Antracite  
33x33 - 12<sup>5/8</sup>"x12<sup>5/8</sup>"



**0003722** Ivory  
33x33 - 12<sup>5/8</sup>"x12<sup>5/8</sup>"



**0003723** Taupe  
33x33 - 12<sup>5/8</sup>"x12<sup>5/8</sup>"

**Imballi / Packing / Verpackungen / Embalajes**

Formato	Pezzi/Sc.	Mq/Sc	Sc/Pal	Mq/Pal	Kg/Sc	Kg/Pal
Size	Pcs/Box	Sq.M/Box	Box/Pal	Sq.M/Pal	Kg/Box	Kg/Pal
Größe	Pcs/Ctn	Mq/Ctn	Ctn/Pal	Mq/Pal	Kg/Ctn	Kg/Pal
Format	Stck/Kart	Qm/Kart	Kart/Pal	Qm/Pal	Kg/Kart	Kg/Pal
Tamaño	Piezas/Caja	Mq/Caja	Caja/Pal	Mq/Pal	Kg/Caja	Kg/Pal
<b>32x75</b>	<b>5</b>	<b>1,20</b>	<b>32</b>	<b>38,40</b>	<b>23,4</b>	<b>748,8</b>
<b>32x32</b>	<b>12</b>	<b>1,23</b>	<b>48</b>	<b>59,04</b>	<b>21,4</b>	<b>1027,2</b>



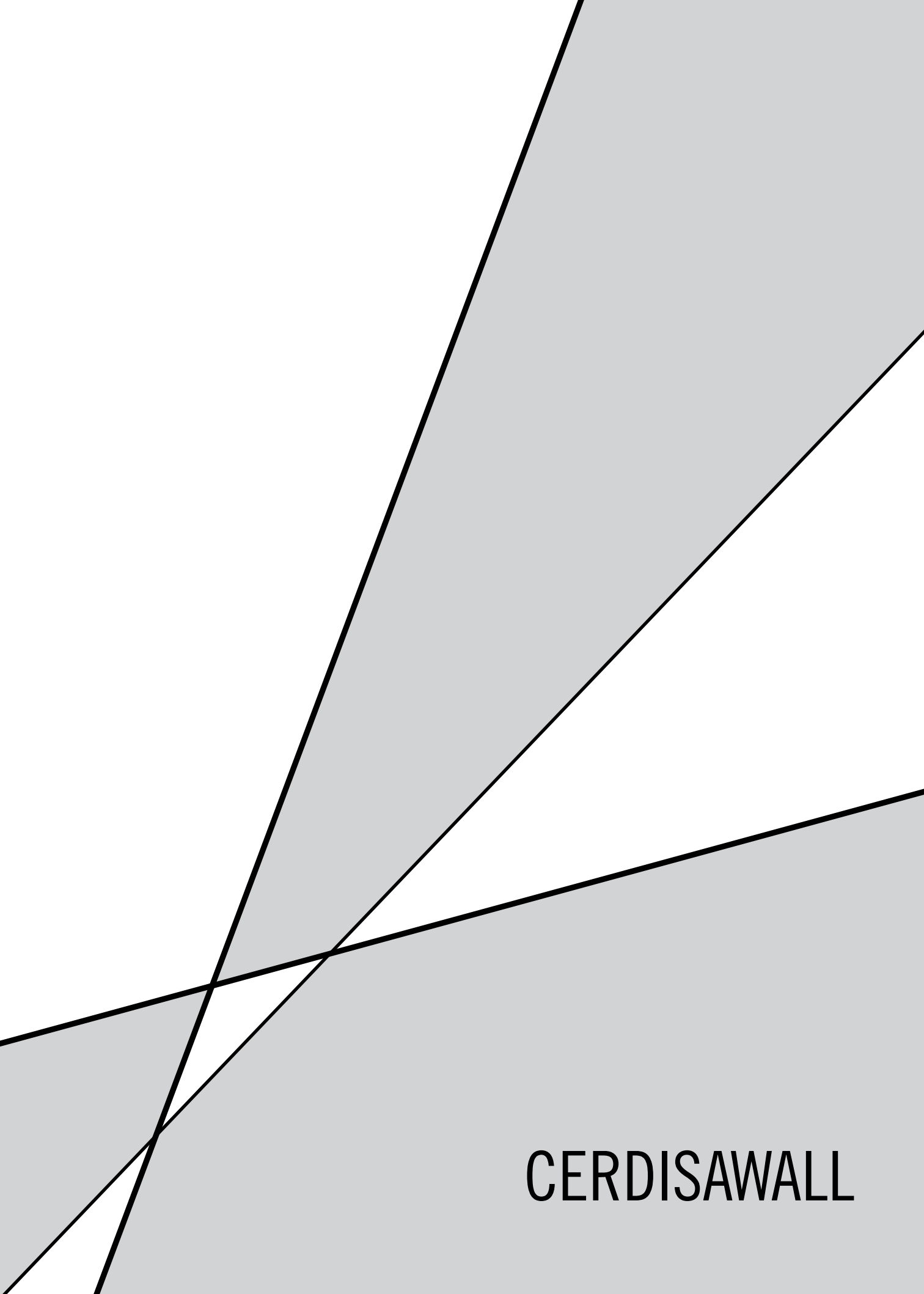

CERDISAWALL

# PERLAGE

Rivestimento in bicottura - Monoporosa B III EN 14411 / Double fired wall tiles - Monoporosa / Wandfliesen - Zweibrandverfahren - Monoporosa  
Revêtement mural - Bricuisson - Monoporosa / Revestimientos - Bicocción - Monoporosa







**Rivestimento in bicottura - Monoporosa B III EN 14411** / Double fired wall tiles - Monoporosa / Wandfliesen - Zweibrandverfahren - Monoporosa  
 Revêtement mural - Bicuissin - Monoporosa / Revestimientos - Biccoción - Monoporosa



**0060060** Bianco 20x50



**0060070** Arancio 20x50



**0060072** Ciliegia 20x50



**0060071** Bordeaux 20x50



**0060074** Blu 20x50



**0060075** Listello Seta Perla  
 20x50 - 8"x20"  
 6 pcs x box



**0060066** Listello Round Rosso-Arancio-Bordeaux  
 20x50 - 8"x20"  
 6 pcs x box



**0060067** Listello Round Blu  
 20x50 - 8"x20"  
 6 pcs x box



**0040106** Bacchetta Universale Silver  
 1,5x50 - 3/4"x20"  
 6 pcs x box



**0060068** Listello Arancio-Bordeaux  
 4,5x50 - 1 7/8"x20"  
 6 pcs x box



**0060069** Listello Blu  
 4,5x50 - 1 7/8"x20"  
 6 pcs x box

**PAVIMENTI COORDINATI LIFE 33,3x33,3 - 13"x13"** / COORDINATED FLOOR TILES / KOORDINIERTE BODENFLIESEN / SOLS COORDONNÉS / PAVIMENTOS COORDINADOS

**Gres porcellanato smaltato EN 14411 Bla** / Glazed porcelain stoneware / Glasiertes Steinzeug / Grès porcelainé émaillé / Gres porcelánico esmaltado

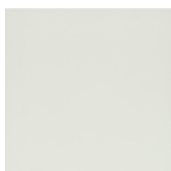

**0070466** Vela  
 33x33 - 12<sup>5/8</sup>"x12<sup>5/8</sup>"



**0111449** Arancio  
 33x33 - 12<sup>5/8</sup>"x12<sup>5/8</sup>"



**0554860** Bordeaux  
 33x33 - 12<sup>5/8</sup>"x12<sup>5/8</sup>"



**0554859** Blu  
 33x33 - 12<sup>5/8</sup>"x12<sup>5/8</sup>"

**Imballi / Packing / Verpackungen / Emballages / Embalajes**

Formato	Pezzi/Sc.	Mq/Sc	Sc/Pal	Mq/Pal	Kg/Sc	Kg/Pal
Size	Pcs/Box	Sq.M/Box	Box/Pal	Sq.M/Pal	Kg/Box	Kg/Pal
Grösse	Pcs/Ctn	Mq/Ctn	Ctn/Pal	Mq/Pal	Kg/Ctn	Kg/Pal
Format	Stck/Kart	Qm/Kart	Kart/Pal	Mq/Pal	Kg/Kart	Kg/Pal
Tamaño	Piezas/Caja	Mq/Caja	Caja/Pal	Mq/Pal	Kg/Caja	Kg/Pal
<b>20x50</b>	<b>11</b>	<b>1,10</b>	<b>48</b>	<b>52,80</b>	<b>21,7</b>	<b>1041,6</b>



Bordeaux 20x50  
Listello Round Rosso-Arancio-Bordeaux 20x50  
Bacchetta Universale Silver 1,5x50

# TREND

**Rivestimento in bicottura - Monoporosa B III EN 14411** / Double fired wall tiles - Monoporosa / Wandfliesen - Zweibrandverfahren - Monoporosa  
Revêtement mural - Bricuisson - Monoporosa / Revestimientos - Bicocción - Monoporosa





**Rivestimento in bicottura - Monoporosa B III EN 14411** / Double fired wall tiles - Monoporosa / Wandfliesen - Zweibrandverfahren - Monoporosa  
 Revêtement mural - Bricuison - Monoporosa / Revestimientos - Bicoccción - Monoporosa

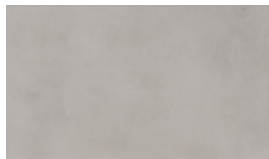

**0060010** Grigio 25x42,5

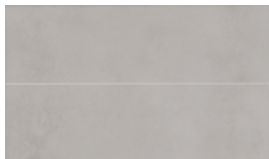

**0060011** List. Inciso Grigio 25x42,5  
6 pcs x box

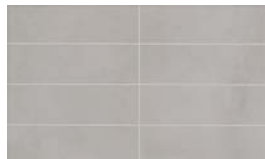

**0060012** Mosaico Inciso Grigio 25x42,5  
6 pcs x box

**0060004** Matita Alluminio  
1,5x42,5 - 3/4"x17"  
6 pcs x box



**0060000** Beige 25x42,5



**0060001** List. Inciso Beige 25x42,5  
6 pcs x box



**0060002** Mosaico Inciso Beige 25x42,5  
6 pcs x box

**0060005** Matita Rosso  
1x42,5 - 3/2"x17"  
6 pcs x box



**0060020** Cacao 25x42,5



**0060021** List. Inciso Cacao 25x42,5  
6 pcs x box



**0060022** Mosaico Inciso Cacao 25x42,5  
6 pcs x box

**0060006** Matita Cacao  
1x42,5 - 3/2"x17"  
6 pcs x box



**0060007** Listello Grigio/Rosso  
5x42,5 - 2"x17"  
6 pcs x box



**0060008** Listello Beige/Cacao  
5x42,5 - 2"x17"  
6 pcs x box

**PAVIMENTI COORDINATI PORTLAND 45x45 - 18"x18"** / COORDINATED FLOOR TILES / KOORDINIERTE BODENFLIESEN / SOLS COORDONNÉS / PAVIMENTOS COORDINADOS

**Gres porcellanato colorato in massa EN 14411 Bia** / Colorbody porcelain stoneware / Durghgefärbtes steinzeug / Grès cérame coloré dans la masse / Gres porcelánico coloreado en toda la masa



**0077546** Grigio Chiaro  
45x45 - 18"x18"



**0077547** Grigio Azzurro  
45x45 - 18"x18"



**0077545** Beige  
45x45 - 18"x18"

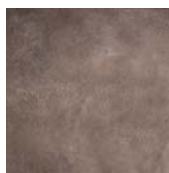

**0077548** Bronzo  
45x45 - 18"x18"

**Imballi / Packing / Verpackungen / Emballages / Embalajes**

Formato	Pezzi/Sc.	Mq/Sc	Sc/Pal	Mq/Pal	Kg/Sc	Kg/Pal
Size	Pcs/Box	Sq.M/Box	Box/Pal	Sq.M/Pal	Kg/Box	Kg/Pal
Grösse	Pcs/Ctn	Mq/Ctn	Ctn/Pal	Mq/Pal	Kg/Ctn	Kg/Pal
Format	Stck/Kart	Qm/Kart	Kart/Pal	Mq/Pal	Kg/Kart	Kg/Pal
Tamaño	Piezas/Caja	Mq/Caja	Caja/Pal	Mq/Pal	Kg/Caja	Kg/Pal
<b>25x42,5</b>	<b>8</b>	<b>0,85</b>	<b>66</b>	<b>56,1</b>	<b>15</b>	<b>990</b>



Beige 45x45  
Beige 25x42,5  
Mosaico Inciso Beige 25x42,5  
Listello Beige/Cacao 5x42,5

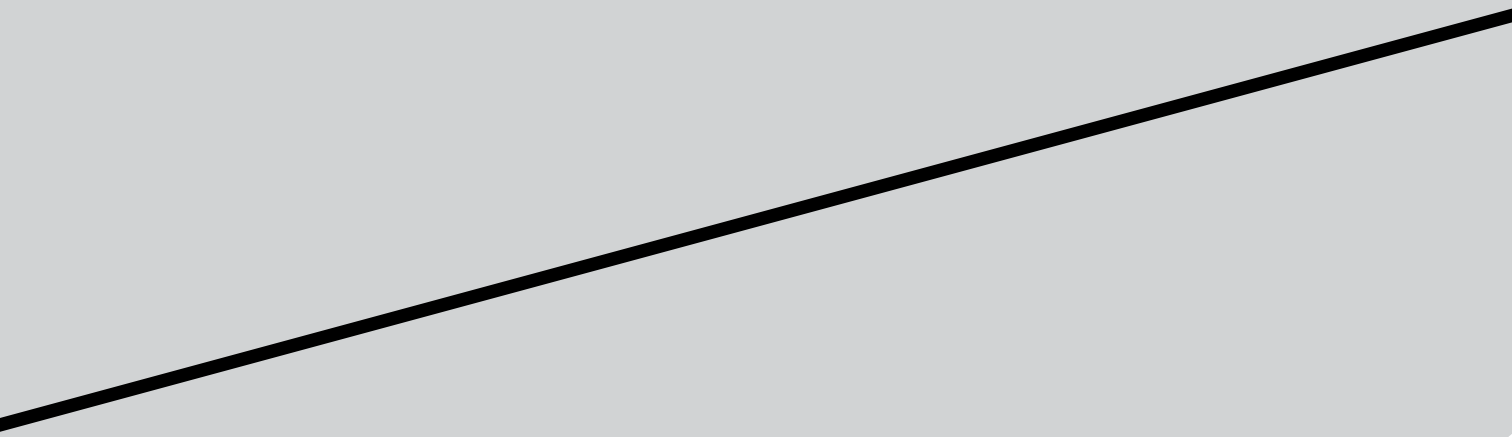

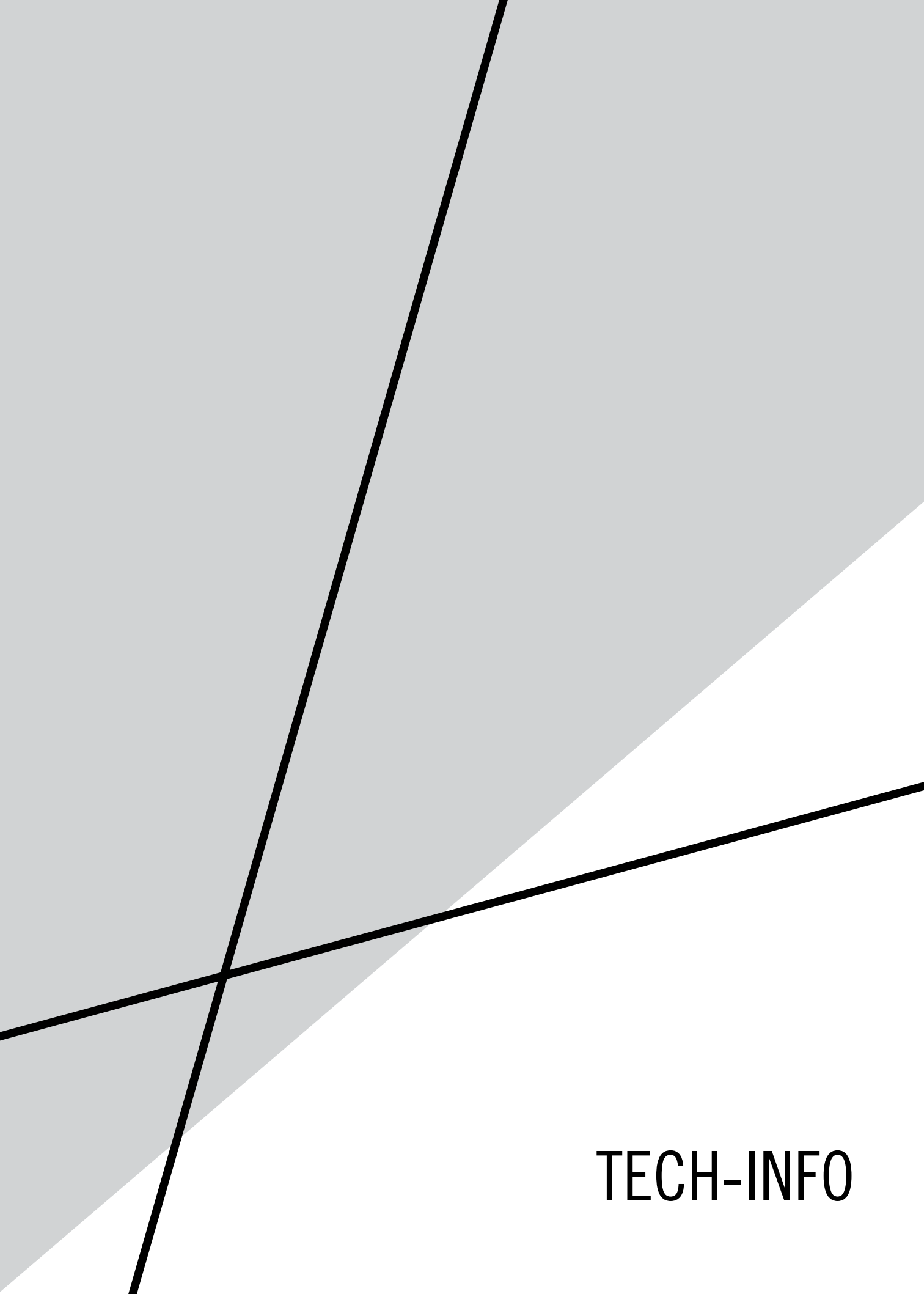

TECH-INFO



# CERTIFICAZIONI

CERTIFICATIONS / ZERTIFIZIERUNGEN / CERTIFICATIONS / CERTIFICACIONES

## SIMBOLOGIA

KEY TO SYMBOLS / SYMBOLE / SYMBOLOGIE / SIMBOLOGÍA



PAVIMENTO  
WALL TILES  
REVÊTEMENT  
WANDVERKLEIDUNG  
PAVIMENTO



RIVESTIMENTO  
WALL TILES  
REVÊTEMENT  
WANDVERKLEIDUNG  
REVESTIMIENTO



GRES PORCELLANATO TUTTA MASSA  
FULL BODY PORCELAIN STONEWARE  
GRES PORCELAINÉ PLEINE MASSE  
FEINSTEINZEUG IN DER MASSE GEFÄRBT  
GRES PORCELÁNICO EN TODA SU MASA



SCHLÖSSTÄ  
SLIP FACTOR  
GLISSANCE  
GLATTE  
RESBALAMIENTO



SPESSORE  
THICKNESS  
ÉPAISSEUR  
STÄRKE  
ESPESOR



INGELIVO  
FROST PROOF  
INGELFEE  
FROSTSICHER  
RESISTENTE AL HIELO



RESISTENZA ALL'ABRASIONE  
RESISTANCE TO ABRASION  
BESTÄNDIGKEIT GEGEN OBERFLÄCHENVERSCHEISS  
RÉSISTANCE À L'ABRASION  
RESISTENCIA A LA ABRASIÓN



ASPETTO UNIFORME  
UNIFORM APPEARANCE  
ASPECT UNIFORME  
GLEICHARTIGES AUSSEHEN  
ASPECTO UNIFORME



LIEVE VARIAZIONE  
SLIGHT VARIATION  
LEGERE VARIATION  
LEICHTE SCHÄTTIERUNG  
LEVE VARIACION



MODERATA VARIAZIONE  
MODERATE VARIATION  
VARIATION MODÉRÉE  
MASSIGE SCHÄTTIERUNG  
MODERADA VARIACION



FORTE STONALIZZAZIONE  
SUBSTANTIAL VARIATION  
EFFET DENUANCE TRÈS ACCENTUÉE  
STARKE SCHÄTTIERUNG  
FUERTE DESTONIFICADO



Un metodo semplice e significativo per definire il grado di compatibilità fra pavimento e destinazione d'uso, cioè fra pavimento e caratteristiche ambientali, è il "Classement UPEC", metodo francese costituito da una classificazione dei locali/edifici in relazione alla severità delle condizioni d'impiego e ai conseguenti livelli di prestazione richiesti alla pavimentazione, indicato dalle lettere:

**U** = grado di resistenza all'usura e all'abrasione (indici da 1 a 4 con numero crescente in relazione alla maggiore resistenza).

**P** = grado di resistenza meccanica (indici da 1 a 4 con numero crescente in relazione alla maggiore resistenza).

**E** = comportamento dell'acqua (indici da 0 a 3 con numero crescente in relazione al miglior comportamento).

**C** = comportamento ai prodotti chimici e alle macchie (indici da 0 a 3 con numero crescente in relazione alla maggiore resistenza ad acidi, basi e prodotti macchianti).

A simple and significant method to define the grade of compatibility between the floor and the settled function, that is between the floor and the environmental features, is the "Classement UPEC", french method constituted by the rating of the premises in relation to the severity of the application terms and to the consequent levels of performance required by the flooring. The rating uses the following letters:

**U** = grade of wear and abrasion resistance (indexes from 1 to 4 with number increasing in relation to greater resistance).

**P** = grade of mechanical resistance (indexes from 1 to 4 with number increasing in relation to greater resistance).

**E** = water absorption (indexes from 0 to 3 with number increasing in relation to better absorption).

**C** = resistance to chemical products and staining (indexes from 0 to 3 with number increasing in relation to greater resistance to acids, alkalies and staining products).

Eine einfache und bedeutende Methode zur Bestimmung der Verträglichkeitsstufe zwischen Boden und eingesetzter Funktion bzw Boden und Umweltbedingungen ist "UPEC Klassifizierung": es geht um eine französische Methode, die aus einer Einstufung der Lokale und Gebäude nach den Gebrauchskonditionen und den folgenden vom Boden erforderten Leistungsniveau wie folgt besteht:

**U** = Abrieb und Abschlagsgruppe (Indexziffer von 1 bis 4 mit größerer Nummer nach größerer Widerständigkeit).

**P** = Mechanische Beständigkeit (Indexziffer von 1 bis 4 mit größerer Nummer nach größerer Widerständigkeit).

**E** = Wasserverhalten (Indexziffer von 0 bis 3 mit größerer Nummer nach besserem Verhalten).

**C** = Beständigkeit auf chemische Produkte und Flecke (Indexziffer von 0 bis 3 mit größerer Nummer nach größerer Beständigkeit auf Säure-Base und befleckte Produkte).

Une simple et significative méthode pour établir le degré de compatibilité entre sol et fonction installée, c'est-à-dire entre sol et caractéristiques du milieu ambiant est le "Classement UPEC", méthode française représentée par une classification des locaux et des établissements par rapport à la sévérité des conditions d'emploi et aux conséquents niveaux de performances nécessaires au pavage, comme suit:

**U** = Degré de résistance à l'usure et à l'abrasion (indices de 1 à 4 avec numero croissant par rapport à la résistance majeure).

**P** = Degré de résistance mécanique (indices de 1 à 4 avec numero croissant par rapport à la résistance majeure).

**E** = Comportement de l'eau (indices de 0 à 3 avec numero croissant par rapport au meilleur comportement).

**C** = Réaction aux produits chimiques et aux taches (indices de 0 à 3 avec numero croissant par rapport à la résistance majeure aux acides, bases et produits tachants).

Un método simple y significativo para definir el grado de compatibilidad entre suelo y función establecida, es decir, entre suelo y características ambientales, es el "Classement UPEC", método francés basado en una clasificación de los locales de los edificios según la severidad de las condiciones de empleo y los consecuentes niveles de prestación requeridos parwdicados por las letras:

**U** = grado de resistencia al desgaste y a la abrasión (índice de 1 a 4 con número creciente con relación a la mayor resistencia).

**P** = grado de resistencia mecánica (índice de 1 a 4 con número creciente con relación a la mayor resistencia).

**E** = comportamiento del agua (índice de 0 a 3 con número creciente con relación al mejor comportamiento).

**C** = resistencia a los productos químicos y a las manchas (índice de 0 a 3 con número creciente con relación a la mayor resistencia a ácidos, bases y productos que pueden manchar).



L'azienda assolve agli obblighi sulla marcatura CE. / The Company fulfils its CE marking obligations. Die Firma erfüllt die Verpflichtungen für das CE-Kennzeichnung. / Conformément aux dispositions en matière de marquage CE. / La empresa cumple con las obligaciones del sello CE.

## LE NORME EN 14411 / EN 14411 STANDARDS / NORMES EN 14411 / EN 14411 NORMEN / NORMAS EN 14411

**CLASSIFICAZIONE DELLE PIASTRELLE SECONDO GRUPPO DI APPARTENENZA E NORMA DI PRODOTTO** / CLASSIFICATION OF CERAMIC TILES ACCORDING TO SPECIFIC GROUP AND RELATED NORM / CLASSIFICATION DES CARREAUX CERAMIQUES EN FONCTION DU GROUPE D'APPARTENANCE ET NORME DE PRODUIT / KLASSIFIZIERUNG DER KERAMIK FLIESEN NACH ZUGEHÖRIGKEITS-GRUPPE UND PRODUKTNORME / CLASIFICACIÓN DE LAS BALDOSAS SEGÚN GRUPO DE PERTENENCIA Y NORMA DE PRODUCTO

Gruppo B Ia Group B Ia Grupe B Ia Gruppe B Ia Grupo B Ia (Standard EN 14411 Annex G)	$E \leq 0,5\%$
Gruppo B Ib Group B Ib Grupe B Ib Gruppe B Ib Grupo B Ib (Standard EN 14411 Annex H)	$0,5 < E \leq 3\%$
Gruppo B IIa Group B IIa Grupe B IIa Gruppe B IIa Grupo B IIa (Standard EN 14411 Annex J)	$3 < E \leq 6\%$
Gruppo B IIb Group B IIb Grupe B IIb Gruppe B IIb Grupo B IIb (Standard EN 14411 Annex K)	$6 < E \leq 10\%$
Gruppo B III Group B III Grupe B III Gruppe B III Grupo B III (Standard EN 14411 Annex L)	$E > 10\%$

### ASSORBIMENTO D'ACQUA

WATER ABSORPTION / ABSORPTION D'EAU / WASSERABSORPTION / ABSORCIÓN DE AGUA



ASTM International è il più grande ente di normazione al mondo su base volontaria, ed è riconosciuto come fonte affidabile di norme tecniche su materiali, prodotti, sistemi e servizi. Note per la loro alta qualità tecnica ed attinenza al mercato, le norme ASTM rivestono un ruolo di primaria importanza all'interno della infrastruttura informativa che guida le attività di progettazione, costruzione e commerciali su scala mondiale.

ASTM International is the world's largest voluntary standards organisation, and is respected as a reliable source of technical standards on materials, products, systems and services. Known for their high technical quality and market-relevance, ASTM standards play a role of primary importance within the IT infrastructures that provide guidance for design, construction and commercial activities worldwide.

Die ASTM International ist die größte Standardisierungsorganisation weltweit. Die Verwendung ihrer Standards ist freiwillig. Sie gilt als zuverlässige Quelle von technischen Normen für Materialien, Produkte, Systeme und Dienstleistungen. Die ASTM-Standards, bekannt wegen ihrer hohen technischen Qualität und Marktbezogenheit, spielen in der Informationsinfrastruktur, die den Entwicklungs-, Herstellungs- und Vertriebsaktivitäten in der ganzen Welt zugrunde liegt, eine erstrangige Rolle.

Le piastrelle di ceramica sono suddivise in gruppi secondo il loro metodo di formatura (estruse o pressate a secco) ed il loro assorbimento d'acqua. Le piastrelle formate a partire da materie prime ridotte in polvere o piccoli grani e forgiate in stampi a pressione elevata, appartengono al gruppo "B". Queste possono essere smaltate o non smaltate. Le piastrelle sono suddivise inoltre in gruppi di assorbimento d'acqua. Le norme di prodotto definiscono per ogni gruppo: Le dimensioni e la qualità della superficie, le proprietà fisiche, le proprietà chimiche, la marcatura e la designazione delle piastrelle e degli imballaggi.

Ceramic tile types are subdivided into groups in accordance with the method of forming used in their production and in accordance with their water absorption values. High pressed tile manufactured from powder or granulate material belong to the "B" group. Like extruded tiles, pressed tile may be either glazed or unglazed. Apart from the above groupings, ceramic tile sub-divide into different water absorption categories. The above product norms also give the dimensional tolerances required for each grouping and sub-grouping, and determine the mechanical, physical and chemical characteristics and specifications together with the appearance of the ceramic tiles.

Die Keramikfliesen werden je nach der zu ihrer Formung verwendeten Methode und ihrer Wasserabsorption in Gruppen unterteilt. Mit dem Buchstaben B werden diejenigen Fliesen bezeichnet, die aus in Pulver oder Körnchenform vorliegenden Rohstoffen hergestellt und unter hohem Druck in Pressformen geformt werden. Sie können glasiert oder nicht glasiert sein. Weiterhin werden Fliesen in Gruppen nach Wasserabsorption unterteilt: Die Produktnormen legen für jede Gruppe Maßbezugsgröße, Maßabweichungen, mechanische, physikalische und chemische Eigenschaften sowie Aussehen und Bezeichnung fest.

Les carreaux de céramique se distinguent selon leur type de moulage et de leur absorption d'eau. La lettre B est donnée aux carreaux formés à partir de matières premières broyées ou préalable pour obtenir des poudres ou des petits granules et moulées ensuite dans des moules à pression élevée. Ils peuvent être émaillés ou non. Les carreaux se distinguent également selon leur absorption d'eau: Les normes de produit fixent pour chaque groupe les dimensions, les tolérances dimensionnelles, les caractéristiques mécaniques, physiques et chimiques, l'aspect et la désignation de carreaux céramiques.

Las baldosas de cerámica se reparten en grupos, según su método de prensado y su grado de absorción de agua. Las baldosas formadas a partir de materias primas reducidas en polvo o en granos pequeños y formadas en moldes bajo presión elevada pertenecen al grupo B. Estas pueden ser esmaltadas y no esmaltadas. Las baldosas se reparten, además, en grupos según el grado de absorción de agua: Las normas de producto definen, para cada grupo, las dimensiones, las tolerancias de dimensión, las características mecánicas, físicas y químicas y la designación de las baldosas cerámicas.

ASTM International est le plus grand organisme d'élaboration de normes volontaires au monde, reconnu comme une source fiable de normes techniques pour les matériaux, produits, systèmes et services. Connues pour leur haute qualité technique et leur pertinence sur le marché, les normes internationales ASTM jouent un rôle majeur dans l'infrastructure d'information qui guide les activités de conception, fabrication et de commerce à l'échelle mondiale.

ASTM International es el mayor organismo mundial de reglamentación voluntaria y cuenta con el reconocimiento general como fuente fiable de emanación de normas técnicas sobre materiales, productos, sistemas y servicios. Conocidas por su alta calidad técnica y su cercanía a la realidad del mercado, las normas ASTM desempeñan una función de importancia primordial dentro de la infraestructura informativa que guía tareas como el diseño de proyectos, la construcción de edificios y las actividades comerciales a escala mundial.

# CERTIFICAZIONI

CERTIFICATIONS / ZERTIFIZIERUNGEN / CERTIFICAZIONI / CERTIFICACIONES



Cerdisa è membro del Green Building Council Italia, associazione che promuove la cultura dell'edilizia sostenibile energeticamente efficiente, rispettosa dell'ambiente contribuendo a migliorare la qualità della vita dei cittadini attraverso lo standard di certificazione LEED®.

Cerdisa is a member of the Green Building Council Italia, an association that promotes sustainable energy-efficient building practices, which are environmentally friendly and help improve the quality of life through LEED® certification standards.

Cerdisa, die Mitglied des Green Building Council Italien ist, ein Verband, der die Kultur des nachhaltigen und energieeffizienten, umweltverträglichen Bauens fördert, indem zur Lebensqualität der Mitmenschen durch die Zertifizierung nach den LEED®-Standards beigetragen wird.



Cerdisa ha ottenuto la certificazione di qualità Bureau Veritas Certification. Questa certificazione è riconosciuta in tutto il mondo e consiste nell'ispezione e nella verifica dei prodotti, dei progetti e dei sistemi, in riferimento a standard interni, a norme obbligatorie e volontarie a livello nazionale ed internazionale, al fine di fornire un rapporto di conformità. Tutto questo crea un valore aggiunto all'azienda attraverso un supporto nella gestione del rischio, nel controllo della filiera e nell'incremento dei risultati socio-economici.

Cerdisa has received Bureau Veritas Certification quality certification. This certification, recognised all over the world, involves the inspection and auditing of products, designs and systems, in relation to in-house standards and national and international compulsory and voluntary norms, to allow issue of a conformity report. All this creates value-added for the company by assisting it in risk management, control of the supply chain and the improvement of socio-economic results.

Cerdisa erhielt die Qualitätszertifizierung von Bureau Veritas Certification. Diese Zertifizierung ist weltweit anerkannt und besteht in der Inspektion und Prüfung der Produkte, Projekte und Systeme bezüglich der Erfüllung unternehmensinterner Standards sowie nationaler und internationaler obligatorischer und freiwilliger Normen. Aufgrund eines Supports im Risikomanagement, der Lieferantenkontrolle und der Steigerung der sozialen und wirtschaftlichen Resultate handelt es sich für das Unternehmen um eine wertschöpfende Maßnahme.



La certificazione CCC, introdotta nel 2002 interessa sia i prodotti di importazione che quelli di produzione cinese destinati a quel mercato. Le informazioni sulla certificazione CCC riguardano in generale la sicurezza e la salute, con particolare riferimento, nel caso delle piastrelle di ceramica, alle sole piastrelle in gres porcellanato, con un assorbimento minore o uguale allo 0,5%. La certificazione si ottiene attraverso l'intervento di istituti appositamente accreditati dalle autorità cinesi, tutti con sede in Cina.

CCC certification, introduced in 2002, applies to products both imported to China and produced in the country for the Chinese market. Information concerning CCC certification generally relates to health and safety. In the case of ceramic tiles, reference is made specifically only to porcelain tiles having water absorption of 0.5% or less. Certification is obtained through institutions specifically accredited by the Chinese authorities, all based in China.

Die im Jahr 2002 eingeführte CCC-Zertifizierung betrifft sowohl in China importierte als auch in China produzierte Erzeugnisse, die für den chinesischen Markt bestimmt sind. Die Informationen über die CCC-Zertifizierung betreffen im Allgemeinen die Sicherheit und Gesundheit und im Bereich von Keramikfliesen insbesondere die Feinsteinzeugfliesen mit einer Wasseraufnahme kleiner oder gleich 0,5 %. Das Zertifizierungsverfahren erfolgt durch die von den chinesischen Behörden akkreditierten Stellen, die sämtlich ihren Geschäftssitz in China haben.

Cerdisa est une membre du GBC Italia (Green Building Council Italia) qui est une association dont l'objectif est de favoriser et accélérer la diffusion d'une culture du bâtiment durable énergétiquement efficace, respectueuse de l'environnement, en sensibilisant l'opinion publique quant à son impact sur la qualité de la vie des citoyens, à travers du système de certification LEED®.

Cerdisa es miembro del Green Building Council Italia, asociación que promueve la cultura de la construcción sostenible energéticamente eficiente, respetuosa con el medio ambiente, contribuyendo a mejorar la calidad de vida de los ciudadanos a través del estándar de certificación LEED®.

Cerdisa a obtenu la certification de qualité Bureau Veritas Certification. Reconnue dans le monde entier, cette certification consiste à inspecter et à vérifier des produits, des projets et des systèmes par rapport à ses référentiels propres, à des normes obligatoires et volontaires, au niveau national et international, pour délivrer ensuite des rapports de conformité. Un support de la gestion des risques, du contrôle de la filière et de l'accroissement des résultats socio-économiques créent ainsi une valeur ajoutée pour l'entreprise.

Cerdisa cuenta con la certificación de calidad Bureau Veritas Certification. Esta certificación, reconocida en el mundo entero, se obtiene tras someter a rigurosa inspección y control productos, proyectos y sistemas que, para ser declarados conformes, deben atenerse a estándares internos y normas obligatorias y voluntarias tanto de ámbito estatal como internacional. De este modo la empresa se dota de un elemento de soporte en la gestión del riesgo y en el control del conjunto del proceso productivo que le reporta un valor añadido y redunda en el incremento de sus resultados socioeconómicos.

La certification CCC, introduite en 2002, intéresse aussi bien les produits d'importation que ceux de production chinoise destinés à ce marché. Les informations sur la certification CCC concernent en général la sécurité et la santé, avec une référence toute particulière, dans le cas des carreaux en céramique, uniquement aux carreaux en grès cérame, à absorption inférieure ou égale à 0,5%. On l'obtient par l'intermédiaire d'organismes de certification et d'accréditation chinois, tous avec siège en Chine.

La certificación CCC, introducida en 2002, concierne tanto a los productos de importación como a los de producción china destinados a ese mismo mercado. La información acerca de la certificación CCC atañe en general a la seguridad y la salud, con especial referencia, en el caso de las baldosas de cerámica, solamente a las baldosas de gres porcelánico, con una absorción inferior o igual al 0,5%. Se consigue a través de la intervención de instituciones específicamente acreditadas por las autoridades chinas, todas ellas sitas en China.



**CERTIFICAZIONE SISTEMA DI QUALITÀ ISO 9001**  
 QUALITY SYSTEM CERTIFICATION ISO 9001  
 CERTIFICATION SYSTÈME DE QUALITÉ ISO 9001  
 ZERTIFIZIERUNG DES QUALITÄTSSYSTEMS ISO 9001  
 CERTIFICACIÓN DEL SISTEMA DE CALIDAD ISO 9001

Il sistema Qualità di Cerdisa, certificato secondo UNI EN ISO 9001, è la norma internazionale che garantisce la qualità del sistema aziendale a tutti i livelli e in tutta la sua organizzazione: a livello progettuale, produttivo, commerciale e distributivo. Per il marchio Cerdisa di "Gruppo Ceramiche Ricchetti SpA", la certificazione è riferibile ai prodotti del presente catalogo realizzati con la tecnologia denominata CERDISASTONE, del gres fine porcellanato.

The Quality System at Cerdisa is certified to UNI EN ISO 9001, the international standard which guarantees quality in company methods at all levels and throughout the entire company structure: regarding design, production, marketing and distribution. Certification of "Gruppo Ceramiche Ricchetti SpAs" Cerdisa brand refers to the products in this catalogue, which are made with CERDISASTONE technology for fine, porcelain stoneware.

Le système Cerdisa de certification UNI EN ISO 9001, est la norme internationale garantissant la qualité d'une entreprise à tous les niveaux de son organisation : étude, production, commercialisation et distribution. Pour la marque Cerdisa du "Gruppo Ceramiche Ricchetti SpA", la certification de référence des produits de ce catalogue, est réalisée suivant la technologie dénommée CERDISASTONE, du grès fin cérame.

Das Qualitätssystem von Cerdisa, das nach UNI EN ISO 9001 zertifiziert worden ist, folgt der internationalen Norm, die die Betriebsqualität auf allen Ebenen und in jeder Hinsicht garantiert: im Verkauf und Vertrieb. Für die Marke Cerdisa der "Gruppo Ceramiche Ricchetti SpA" bezieht sich die Zertifizierung auf die Produkte des vorliegenden Katalogs, die mit der als CERDISASTONE bezeichneten Technik für Feinsteinzeug hergestellt worden sind.

El sistema de calidad Cerdisa, certificado según UNI EN ISO 9001, es la norma internacional que garantiza la calidad del sistema empresarial a todos los niveles y en toda su organización: diseño, producción, comercialización y distribución. Para la marca Cerdisa de "Gruppo Ceramiche Ricchetti SpA" la certificación se refiere a los productos del presente catálogo realizados con la tecnología denominada CERDISASTONE del gres fino porcelánico.



**CERTIFICAZIONE DEI SISTEMI DI GESTIONE AMBIENTALE DELLE AZIENDE ISO 14001**  
 CERTIFICATION OF COMPANY ENVIRONMENTAL MANAGEMENT SYSTEM ISO 14001  
 CERTIFICATION DES SYSTÈMES DE GESTION ENVIRONNEMENTALE DES ENTREPRISES ISO 14001  
 ZERTIFIZIERUNG DER UMWELTMANAGEMENTSYSTEME VON UNTERNEHMEN ISO 14001  
 CERTIFICACIÓN DE LOS SISTEMAS DE GESTIÓN AMBIENTAL DE LAS EMPRESAS ISO 14001

Tra gli obiettivi prioritari dell'industria delle piastrelle ceramiche del comprensorio di Sassuolo-Maranello c'è la tutela dell'ambiente attraverso la continua valutazione degli impatti ambientali, al fine di perseguire il miglioramento dei problemi di inquinamento. Gruppo Ceramiche Ricchetti S.p.A. azienda leader nella produzione di piastrelle, ha da sempre fatto propri questi obiettivi ottenendo nel Luglio 2003 la relativa certificazione prevista dalla norma ISO 14001.

One of the top priorities of the ceramic tile industry in the Sassuolo-Maranello district is environmental protection, a goal we pursue through continual environmental impact assessment to reduce pollution problems. As a leading tile manufacturer, Gruppo Ceramiche Ricchetti S.p.A. has always pursued these objectives and in July 2003 obtained certification for the ISO 14001 standard in environmental management systems.

Parmi les objectifs prioritaires de l'industrie des carreaux céramiques de la zone Sassuolo-Maranello figure la sauvegarde de l'environnement. C'est en effet par l'évaluation permanente des impacts environnementaux que ce secteur cherche à réduire les problèmes de pollution. Gruppo Ceramiche Ricchetti S.p.A., chef de file dans la production de carreaux, s'est depuis toujours fixé ces objectifs et a obtenu en juillet 2003 la certification correspondante prévue par la norme ISO 14001.

Zu den wichtigsten Zielen der Keramikfliesen-Industrie des Bezirks Sassuolo-Maranello gehört der Umweltschutz durch die kontinuierliche Bewertung der Umweltauswirkungen, mit dem Zweck der Verbesserung der Umweltschutzprobleme. Gruppo Ceramiche Ricchetti S.p.A., ein Marktleader in der Produktion von Fliesen, hat sich diese Ziele schon immer zu Eigen gemacht und im Juli 2003 die entsprechende Zertifizierung der Norm ISO 14001 erhalten.

Entre los objetivos primordiales de la industria de baldosas cerámicas del distrito de Sassuolo-Maranello se encuentra la protección del medio ambiente por una evaluación constante del impacto ambiental, a fines de reducir los problemas de la contaminación. Gruppo Ceramiche Ricchetti S.p.A., empresa líder en la producción de baldosas cerámicas, haciendo suyos estos objetivos desde siempre, ha conseguido en julio 2003 la certificación correspondiente prevista por la norma ISO 14001.

# CONSIGLI DI POSA

INSTRUCTIONS FOR LAYING / HINWEISE ZUR VERLEGUNG / CONSEILS POUR LA POSE / CONSEJOS PARA LA COLOCACIÓN

## POSA TRADIZIONALE CON MALTA CEMENTIZIA

- Spessore della malta di allettamento massimo 5-6 cm.
- Dosaggio del legante 300-350 Kg./mc di cemento Portland 325, per impiego generalizzato, dando la preferenza al cemento pozzolanico per posa esterna.
- Rapporto acqua/cemento max 0,5.
- Spolvero di cemento spessore max 2 mm. equivalente a circa 2,8-3,5 Kg./mq.
- Non si può stuccare il pavimento prima di 24 ore dalla posa in opera, ed è ancor meglio se si lasciano trascorrere due o tre giorni. Durante questo tempo il pavimento deve essere protetto da una eventuale troppo rapida evaporazione, con fogli di plastica oppure in mancanza di questi, con continue bagnature. Anche la stuccatura, se eseguita con malta formata da cemento e sabbia, deve essere bagnata, una volta indurita, per almeno tre giorni.

## POSA CON ADESIVI

Da effettuare su caldana precedentemente eseguita e sufficientemente stagionata: in condizioni normali almeno una settimana per ogni cm. di spessore.

- Per impiego dell'adesivo seguire scrupolosamente le modalità d'uso indicate dal produttore. Per pavimentazioni esterne seguire il metodo della doppia spalmatura dell'adesivo (sulla caldana e sul retro della piastrella) oppure usare una spatola senza denti. Quanto detto vale per posa su una struttura con freccia sottocarico inferiore ad 1/400 della luce, per frecce superiori consultare il ns. servizio di assistenza. In ogni caso le piastrelle in CERDISASTONE debbono essere posate fugate e l'ampiezza della fuga deve essere proporzionale al formato: indicativamente min. 2-3 mm.
- È consigliabile eseguire la stuccatura col materiale indicato dal produttore dell'adesivo seguendo le relative istruzioni.
- In previsione dell'impiego di uno stucco colorato, si consiglia di sottoporre una piastrella non posata ad un test di macchiabilità; se la piastrella si macchia esistono tre possibilità:
  1. Rinunciare alla stuccatura colorata, ed impiegare normale malta cementizia;
  2. Trattare con idoneo prodotto le superfici delle piastrelle;
  3. Stuccare mediante l'impiego di una apposita siringa e previa nastratura con carta gommata dei bordi delle piastrelle.La malta di allettamento per la posa tradizionale e la caldana predisposta per la posa con adesivo debbono essere separate dal piano di appoggio mediante uno strato di scorrimento costituito da due fogli sovrapposti di polietilene o materiale similare.
- Per superfici continue di notevoli dimensioni (40 mq. per interni - 20 mq. per esterni), la pavimentazione deve essere provvista di giunti elastici, che devono essere eseguiti come da progetto oppure seguendo le istruzioni della direzione lavori o, in mancanza, del servizio assistenza CERDISA e corrispondenti comunque a non più di 4 m2 di superficie continua per esterni e di 6 m2 per interni. I giunti elastici devono interessare lo spessore delle piastrelle e della malta, nella posa tradizionale e delle piastrelle, dell'adesivo e della caldana nella posa con adesivi. Per eventuali informazioni sulle modalità di esecuzione dei giunti è a disposizione il ns. servizio di assistenza clienti. Si consiglia di posare il CERDISASTONE levigato solamente con adesivi e su superfici perfettamente piane.

## TRADITIONAL LAYING WITH CEMENT MORTAR

- Maximum mortar thickness 5-6 cm.
- Add binding agent in the proportion of 300-350 Kg./m3 of Portland 325, cement for general use; pozzolana cement is to be preferred for laying outdoors.
- Water/cement ratio 0,5 max.
- Dusting with cement max thickness 2 mm. equivalent to approximately 2,8-3,5 Kg./m2.
- The floor cannot be grouted until at least 24 hours after laying, and it is even better to wait for two or three days. During this period the floor must be protected against excessively fast evaporation with plastic sheeting, or if this is not available by continuous wetting. The grouting, if carried out using a cement and sand mortar, must also be wet for at least three days after setting.

## LAYING WITH ADHESIVES

The cement-screed must be prepared well in advance and suitably cured: in normal conditions at least one week for each cm. of thickness.

- Follow the manufacturer's instructions for use of the adhesive in every detail.
- For outdoor laying, use the double application method (spreading adhesive both on the cement-screen and on the back of the tile) or use a smooth-edged spreading tool. This method is acceptable for structures with deflection under load less than 1/400 of span; for higher deflections consult our service organization. In all cases CERDISASTONE tiles must be laid with grout, and the width of the grout must be proportional to the tile size: guideline values are min. 2-3 mm.
- Grout with a material recommended by the adhesive manufacturer, following the relative instructions.
- If a coloured grout is to be used, carry out a stain test on a tile which has not been laid. If the tile stains, there are three possibilities:
  1. Give up the idea of the coloured grout, and use an ordinary cement mortar;
  2. Treat the tile surfaces with a suitable product;
  3. Grout using a special applicator after taping the tile edges with adhesive tape. The cement mortar for conventional laying and the cement-screen prepared for laying with adhesive must be separated from the contact surface by a layer consisting two overlapping sheets of polyethylene or similar.
- For large size continuous surfaces (40 sqm. for indoor settings, 20 sqm. for outdoors) the flooring must include expansion joints, which must be constructed as specified by the architect or following the instructions of the site director. If these instructions are not available, contact the CERDISA service organization. The expansion joints must correspond to not more than 4-5 meters of continuous surface for outdoor installations and 6-8 meters for indoor flooring. The expansion joints must pass through the whole thickness of the tiles and the mortar in conventional laying system, and of the tile, the adhesive and the cement-screen when adhesives are used. Our customer service organization can be contacted for information on the construction of expansion joints.

## TRADITIONELLE VERLEGUNG MIT ZEMENTMÖRTEL

- Max Mörtelstärke 5-6 cm.
- Dosierung Bindemittel 300-350 Kg./m3 Portland 325, zur allgemeinen Verwendung, für Aussenbeläge sollte besser Trass-Zement verwendet werden.
- Verhältnis Wasser-Zement max 0,5.
- Streuzement max Stärke 2 mm. entsprechend ca. 2,8-3,5 Kg./m2.
- Die Verlegungsarbeiten dürfen erst 24 Stunden nach erfolgter Verlegung durchgeführt werden, besser jedoch erst nach zwei oder drei Tagen. Um eine zu schnelle Austrocknung zu vermeiden, muß der Boden während dieser Zeit mit Plastikfolie abgedeckt oder des öfteren befeuchtet werden. Falls die Verlegung mit Zement-Sandmörtel ausgeführt wird, muß der Boden nach Härtung des Mörtels wenigstens drei Tage lang befeuchtet werden.

## VERLEGUNG MIT KLEBMITTELN

Auf einem vorrätigen und ausreichend ausgetrocknetem Unterboden: bei normalen Bedingungen wenigstens eine Woche pro cm. Stärke.

- Bei der Anwendung des Klebmittels müssen die Gebrauchsanweisungen des Herstellers genauestens eingehalten werden;
- Bei der Verlegung von Aussenbelägen muß das Klebmittel entweder doppelt aufgetragen werden (d.h. auf den Unterboden und auf die Fliesenrückseite) oder ein Spachtel ohne Zähne verwendet werden. Hierdurch wird für die Struktur ein Durchbiegungswert erreicht, der entsprechend der verlegten Länge unter 1/400 liegt. Für höhere Werte gibt unsere Kundendienstabteilung die entsprechenden Anweisungen. Auf alle Fälle müssen CERDISASTONE Fliesen mit Fügen verlegt werden. Die Fugenbreite muß auf das gewählte Format abgestimmt werden. Richtwerte: min. 2-3 mm.
- Die Verlegung sollte mit Materialien erfolgen, die vom Hersteller des Klebmittels empfohlen werden. Gebrauchsanweisungen genauestens beachten;
- Sollte farbiges Verlegungsmaterial verwendet werden, ist es ratsam, mit einer unverlegten Fliese einen Flekktest vorzunehmen. Nimmt die Fliese Flecken an, so bestehen drei Möglichkeiten:
  1. Keine gefärbten Materialien sondern normalen Zementmörtel verwenden.
  2. Die Oberfläche der Fliese mit einem entsprechenden Mittel behandeln.
  3. Die Seiten der Fliese mit einem Papier-Klebeband abdecken und das Verlegungsmaterial mit einer Spritze anbringen. Der Zementmörtel für eine traditionelle Verlegung und der für eine Verlegung mit Klebmitteln vorbereitete Unterboden müssen durch eine Schicht von zwei übereinandergelagerten Polyäthylfolien oder einem ähnlichen Material von der Auflagefläche getrennt werden.
- Bei durchgehenden großen Flächen (40 m2 für Innenräume, 20 m2 für Aussenflächen) muß der Bodenbelag mit elastischen Stößen versehen werden, die entsprechend dem Projekt oder nach den Anweisungen der Bauleitung oder aber, falls kein CERDISA-Service o.ä vorliegt, wenigstens alle 4-5 m bei Aussenflächen und 6-8 m. innenflächen, ausgeführt werden müssen. Die elastischen Stöße müssen so ausgelegt sein, daß bei der traditionellen Verlegung die Stärke der Fliese und des Mörtels berücksichtigt werden. Bei einer Verlegung mittels Klebmitteln muß die Stärke der Fliese, des Klebmittels und des Unterbodens berücksichtigt werden. Eventuelle Informationen bezüglich der Ausführung dieser Arbeiten können bei unserem Kundendienst eingeholt werden.

### POSE TRADITIONNELLE AVEC MORTIER DE CIMENT

- Épaisseur maximum du mortier de ciment 5-6 cm.
- Dosage du liant 300-350 Kg./m<sup>3</sup> de ciment Portland 325, pour un emploi généralisé, en donnant la préférence au ciment à la pouzzolane pour pose externe.
- Rapport eau/ciment maxi 0,5.
- Poudre de ciment épaisseur maxi 2 mm. équivalente à environ 2,8-3,5 Kg./m<sup>2</sup>.
- Le carrelage ne peut pas être jointoyé avant 24 heures de sa pose; il est même préférable d'attendre deux ou trois jours. Pendant ce temps, le carrelage doit être protégé d'une évaporation éventuelle trop rapide, par des feuilles de plastique ou, à défaut, par des mouillages continus. Le jointement aussi, s'il est effectué avec du coulis formé de ciment et sable, doit être mouillé, une fois qu'il a pris, pendant au moins trois jours.

### POSE AVEC ADHESIFS

À effectuer sur la sous-couche isolante suffisamment sèche: dans des conditions normales, au moins une semaine pour chaque cm. d'épaisseur.

- Pour l'emploi de l'adhésif, suivre scrupuleusement les indications données par le producteur.
- Pour des carrelages externes, suivre la méthode du double étalement de l'adhésif (sur la sous couche et derrière le carreau) ou bien utiliser une spatule sans dents. Ceci est valable pour faire une structure avec flèche sous charge inférieure à 1/400 de la lumière: pour des flèches supérieures, consulter notre service après-vente. Dans tous les cas, les carreaux en CERDISASTONE doivent être posés avec joints et l'ampleur du joint doit être proportionnelle au format. A titre indicatif: mini 2-3 mm.
- Il est conseillé d'effectuer le jointoiment avec la matière indiquée par le producteur de l'adhésif en suivant les instructions données par ce dernier.
- Si l'on désire employer une matière de jointoiment colorée, il est conseillé de soumettre un carreau non posé à un test de maculage; si le carreau reste taché, il y a trois possibilités:
  1. Renoncer au jointoiment coloré et utiliser du mortier de ciment normal;
  2. Traiter la surface des carreaux avec un produit approprié;
  3. Mettre des bandes de papier gommé sur les bords des carreaux et ensuite jointoyer avec une seringue spéciale. Le mortier de ciment pour la pose traditionnelle et la sous-couche préparée pour la pose avec adhésif doivent être séparés du plan d'appui par une couche constituée de deux feuilles superposées de polyéthylène ou de matière semblable.
- Pour des surfaces continues de très grandes dimensions (40 m<sup>2</sup> pour intérieurs, 20 m<sup>2</sup> pour extérieurs), le carrelage doit avoir des joints élastiques, exécutés selon le projet, ou suivant les instructions de la direction des travaux ou du service après-vente CERDISA et correspondants, de toute façon sans dépasser 4-5 ml. de surface continue pour extérieurs et 6-8 ml. pour intérieurs. Les joints élastiques doivent intéresser l'épaisseur des carreaux dans la pose traditionnelle, et des carreaux, de adhésifs et de la sous-couche dans la pose avec des adhésifs. Pour d'éventuelles informations sur les modalités d'exécution des joints, notre service après-vente est à la disposition des clients.

### COLOCACIÓN TRADICIONAL CON MORTERO DE CEMENTO

- Máximo espesor del mortero del lecho: 5-6 cm.
- Dosificación del aglomerante: 300-350 kg./m<sup>2</sup> de cemento Portland 325, para el empleo general; para la colocación en exteriores, debe preferirse el cemento puzolánico.
- Relación agua/cemento: máx. 0,5
- Espolvoreo de cemento, máximo espesor: 2 mm. equivalente a 2,8-3,5 kg/m<sup>2</sup>, aproximadamente.
- Después de la colocación, es preciso esperar por lo menos 24 horas (mejor aún si transcurren 2 ó 3 días) antes de estucar el pavimento. Durante este lapso de tiempo debe protegerse el pavimento contra una posible evaporación demasiado rápida, poniendo hojas de plástico o bien mojándolo de vez en cuando. También el estucado, si se ha hecho con mortero de cemento y arena, una vez endurecido debe mojarse durante 3 días, por lo menos.

### COLOCACIÓN CON PEGAMENTO SINTÉTICO

Debe hacerse sobre una capa de base hecha anteriormente y suficientemente desecada (en condiciones normales, por lo menos una semana de desecación por cada centímetro de espesor).

- Respecto al uso del pegamento, atégase escrupulosamente a las instrucciones dadas por el productor.
  - Para pavimentaciones exteriores, siga el método del doble untado del pegamento (sobre la capa-base y sobre la parte trasera de la baldosa), o bien utilice una espátula sin dientes. Lo anterior vale para colocación sobre una estructura con flecha bajo carga inferior a 1-400 de la luz; para flechas superiores, consulte nuestro servicio de asistencia. En todo caso, las baldosas en CERDISASTONE deben colocarse con una distancia de separación entre cada dos, la cual ha de ser proporcional al formato. De manera indicativa, puede ser la siguiente: 2-3 mm.
  - Se aconseja usar para el estucado el material indicado por el productor del pegamento, ateniéndose a las instrucciones del mismo.
  - En el caso de que se quiera utilizar un estuque de color, es oportuno hacer una prueba con una baldosa suelta, para comprobar si se mancha; en el caso de que se manche, hay tres soluciones posibles:
    1. renunciar al estucado en color y utilizar mortero de cemento normal;
    2. tratar la superficie de las baldosas con un producto idóneo;
    3. cubrir el borde de las baldosas con una cinta engomada y luego estucar utilizando una jeringa.
- El mortero que constituye el lecho para colocar las baldosas con el sistema tradicional, o la capa-base preparada para la aplicación con pegamento deben separarse respecto a la superficie de apoyo mediante un estrato de deslizamiento, constituido por dos láminas superpuestas de polietileno u otro material similar.
- Para superficies continuas de dimensiones notables (40 m<sup>2</sup> para interiores, 20 m<sup>2</sup> para exteriores), hace falta dotar la pavimentación con juntas elásticas, las cuales deben hacerse conforme al proyecto o bien siguiendo las instrucciones de la Dirección de las Obras o del servicio de asistencia CERDISA; en todo caso, tales juntas deben dejar no más de 4 m<sup>2</sup> de superficie continua en las pavimentaciones exteriores y 6 m<sup>2</sup> en el interior. En el caso de colocación tradicional, con mortero, las juntas elásticas tienen que comprender el espesor de las baldosas y del mortero; cuando se colocan con pegamento, hay que considerar el espesor de las baldosas, del pegamento y de la capa-base. Para recibir más información sobre la forma de realización de las juntas elásticas, diríjase a nuestro servicio de asistencia a la clientela. Se aconseja colocar el CERDISASTONE pulido solamente con pegamento y sobre superficie perfectamente planas.

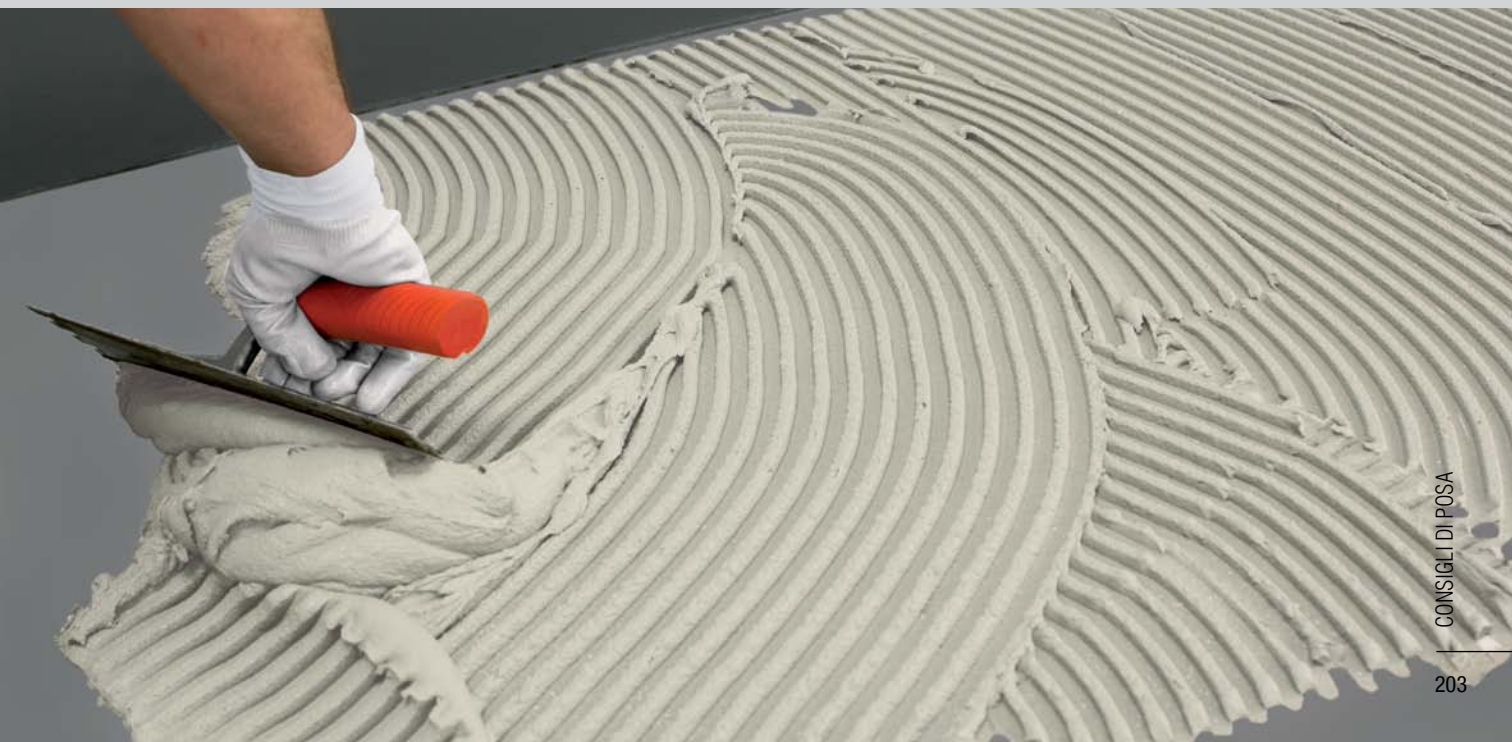

# MANUTENZIONE

## MAINTENANCE / ENTRETIEN / PFLEGE UND REINIGUNG / MANTENIMIENTO

Dopo la pulizia di fine posa, eseguita a regola d'arte con prodotti disincrostanti, tale che ogni traccia di residuo di malta cementizia sia stata opportunamente tolta, i pavimenti sono idonei all'uso; si dovrà solo tenere conto di una pur minima necessità di manutenzione ordinaria che i pavimenti richiederanno nel tempo. Per la pulizia ordinaria dei pavimenti realizzati in CERDISASTONE si possono usare i normali detersivi per pavimenti ceramici, secondo le modalità d'uso consigliate dal produttore, dando la preferenza ai prodotti privi di cere, lacche ed in genere di sostanze lucidanti o abrasive. Nei rari casi in cui si rivelasse la necessità di una manutenzione straordinaria sarà opportuno studiare ogni singolo caso, per determinare quale sia la natura della sostanza o delle sostanze da eliminare e per adottare il metodo di pulizia più idoneo. E comunque buona norma per ogni tipo di macchia intervenire con la massima tempestività, perché ciò si è rivelato risolutivo per la maggioranza dei casi. Le piastrelle delle serie Must e Reflex Design sono trattate con metalli, per la loro pulizia evitare tutti i prodotti che contengono acidi (acido cloridrico, acido fosforico, P 100, N 124, etc.). Si consiglia l'uso di normali detersivi per pavimenti.

After cleaning on completion of laying, with anti-incrustating products, which must be carried out properly to remove all traces of cement mortar etc., the floor is ready for use. Very limited routine maintenance is required to ensure that the flooring retains its appearance over time. For routine cleaning of CERDISASTONE floor, normal detergents available on the market for ceramic floors can be used. Follow the instructions for use. Products without wax, waxes or other polishes or abrasive substances are recommended. If extraordinary maintenance is required, each case should be considered individually to establish the type of substances to be removed and decide on the most appropriate cleaning method. However, action should be taken to remove all marks as quickly as possible, as most stains can be eliminated if tackled immediately. The tiles in the Must and Reflex Design series are treated with metals. Do not use any acid-based products (hydrochloric acid, phosphoric acid, P100, N124/E etc.) for cleaning. We recommend using a standard floor cleaner.

Après le nettoyage de fin de pose effectué selon les règles de l'art avec des produits détartrants dont il ne reste aucune trace de résidu de mortier de ciment, etc., les carrelages sont prêts. Il faudra seulement tenir compte d'un entretien ordinaire que les carreaux demanderont dans le temps. Pour le nettoyage normal des carreaux en CERDISASTONE, on peut utiliser les détergents pour carreaux céramiques que l'on trouve dans le commerce en suivant le mode d'emploi conseillé par le producteur et en donnant la préférence aux produits sans cires, laques et, général, substances polissantes et abrasives. Si, dans le rares cas, un entretien extraordinaire était nécessaire, il faudrait étudier chaque cas séparément pour déterminer la nature de la substance ou des substances à éliminer et pour adopter la méthode de nettoyage la plus appropriée. Il faut de règle intervenir le plus vite possible car cela est décisif dans la plupart des cas. Les carreaux de les series Must et Reflex Design ont subi un traitement à base de métaux. Éviter de les nettoyer avec des produits contenant des acides (acide chlorhydrique, acide phosphorique, P100, N124/E, etc.). Nous recommandons les nettoyeurs ordinaires pour sols.

Nach einer fachgerechten Endreinigung mit Enkrustungsmitteln, bei der alle Mörtelreste usw., gründlich entfernt wurden, können die Fußböden benutzt werden. In der Folge ist nur ein Minimaler Aufwand an Pflege erforderlich. CERDISASTONE-Böden werden entsprechend den Gebrauchsanweisungen mit normalen, im Handel erhältlichen Reinigungsmitteln für Keramikfliesen gesäubert. Hierbei sollten vorzugsweise Produkte benutzt werden, die keine Wache, Lacke, Glanz- oder Scheuermittel enthalten. Bei außergewöhnlichen Verschmutzungen sollte zuerst die Art der zu entfernenden Substanzen überprüft und dann die entsprechende Reinigungsmethode gewählt werden. Grundsätzlich sollten Flecken so schnell wie möglich entfernt werden. In den meisten Fällen erweist sich ein rasches Eingreifen als erfolgreich. Die Fliesen der serie Must und Reflex Design werden mit metallen behandelt. Für ihre reinigung produkte vermeiden, die säuren, (salzsäure, phosphorsäure, P100, N124/E usw.). Enthalten. Zur pflege gewöhnliche bodenreiner verwenden.

Una vez concluida la colocación de las baldosas, hace falta proceder a una detenida limpieza, utilizando productos idóneos, para eliminar todo residuo de mortero de cemento, etc.; con esto los pavimentos quedan listos para su uso; luego será necesario sólo un mínimo mantenimiento ordinario. Para la limpieza habitual de los pavimentos en CERDISASTONE pueden emplearse los detergentes normales para pavimentos cerámicos que se encuentran en el comercio; además siempre a las instrucciones del productor, prefiriendo productos sin ceras, lacas ni sustancias abrillantadoras o abrasivas. En los raros casos en que resulte necesario un mantenimiento extraordinario, será oportuno estudiar cada caso particular, para determinar la naturaleza de la substancia o de las substancias a eliminar y para adoptar el método de limpieza más indicado. En todo caso es buena norma, para todo tipo de mancha, proceder a su eliminación con la máxima tempestividad, lo cual en la mayoría de los casos ha demostrado ser resolutorio. Los azulejos de la serie Must y Reflex Design están tratados con metales; para su limpieza evitar toda clase de productos que contengan ácidos (ácido clorhídrico, ácido fosfórico, P100, N124/E, etc.). Se aconseja el uso de detergentes normales para suelos.

TIPO DI MACCHIA TYPE OF STAIN / TYPE DE TACHE / FLECKENART TIPO DE MANCHA	DETERGENTE DETERGENTS / DÉTERGENT / EINIGUNSMITTEL DETERGENTE
<b>RESIDUI DI CEMENTO, DEPOSITI CALCAREI E TRACCE PIOMBATURA</b> CEMENT RESIDUES, LIME SCALE DEPOSITS AND TRACES OF MATERIALS USED DURING POUSHING / RESIDUOS DE MORTIER DÉPÔT DE CALCAIRE ET TRACES DE PLOMBAGE / ZEMNTRUSTANDE, KALKLAGERUNGEN UND BLEISPUREN / RESIDUOS DE CEMENTO, DEPÓSITOS CALCAREOS Y TRAZAS DE EMPLOMADO	<b>ACIDO DEBOLE ORGANICO (TIPO P100 DELLA CERDISA)</b> WEAK ORGANIC ACID (SUCH AS CERDISAS P100) / ACIDE FAIBLE ORGANIQUE (TYPE P100 DE LA CERDISA) SCHWACHE ORGANISCHE SAURE (TYP P100 VON CERDISA) / ACIDO DÉBIL ORGANICO (TIPO P100 DE LA CERDISA)
<b>MACCHIE DI RUGGINE</b> RUST STAINS / TACHES DE ROUILLE / ROSTFLECKEN / MANCHAS DE HERRUMBLE	<b>PREPARATI A BASE DI ACIDO FOSFORICO</b> PHOSPHORIC ACID BASED PRODUCTS / PRODUITS À BASE D'ACIDE PHOSPHORIQUE / PRODUKT AUF DER BASIS VON PHOSPHORSÄURE / PREPARADOS A BASE DE ÁCIDO FOSFÓRICO
<b>OLII, GRASSI E CERA</b> OIL, GREASE AND WAX / HUILES, GRAISSES ET CIRE / ÖL, FETT UND WACHS / ACETE, GRASAS Y CERA	<b>ALCOOL ETILICO A 90° PER OLI E TRIELINA PER I GRASSI O BICARBONATO E ACQUA O VAPORE</b> 90° PROOF ALCOHOL FOR OIL AND TRICHLOROETHYLENE OR SODIUM BICARBONATE AND WATER OR STEAM FOR GREASE ALCOOL ETHYLIQUE À 90° POUR LES HUILES ET TRICHLOROETHYLENE POUR GRASSES ON BICARBONATE ET EAU OU VAPEUR ETHYLALCOHOL / 90° FÜR ÖL UND TRICHLOROETHYLEN FÜR FETTE ODER BICARBONAT UND WASSER ODER DAMPF ALCOHOL ETILICO DE / 90° PARA LOS ACETES Y TRICLOROETILENO (QUITAMANCHAS) PARA LAS GRASAS O BICARBONATO Y AGUA O VAPORE
<b>MACCHIE DI CATRAME E BITUME E RESIDUI DI MALTA A BASE DI RESINE</b> TAR, BITUMEN AND RESIN BASED MORTAR RESIDUES / TACHES DE Goudron ET DE BITUME ET RESIDUS DE MORTIER / TEER-UND BITUMENFLECKE SOWIE RÜCKSTÄNDE VON HARZMÖRTEL / MANCHAS DE ALQUOTRAN, ASFALTO Y RESIDUOS DE MORTERO A BASE DE RESINAS	<b>SOLVENTI ORGANICI A BASE DI CLORURO DI METILENE O ACETONE</b> METHYLENE CHLORIDE BASED OR ACETONE BASED ORGANIC SOLVENTS / SOLVANTS ORGANIQUES À BASE DE CHLORURE DE METHYL OU ACETONE ORGANISCHE LÖSEMittel AUF DER BASIS VON METHYLCHLORID ODER ACETON / DISOLVENTES ORGANICOS A BASE DE CLORURO DE METILENO O ACETONA
<b>GOCCHE DI COLORE E VERNICE</b> PAINT SPOTS / GOUTTES DE COULEUR ET VERNIS / FARB-UND LACKTROPFEN / GOTAS DE PINTURA Y BARNIZ	<b>SOLVENTE BASE DELLA VERNICE O SVERNICIATORE PER LEGNO</b> SOLVENT USED IN PARTICULAR PAINT OR PAINT REMOVER FOR WOOD SURFACES / SOLVANT BASE DU VERNIS OU DÉCAPANT POUR BOIS / GRUNDLÖSEMittel FÜR LACK ODER ABBEZMittel FÜR HOLZ / DISOLVENTE BASE DEL BARNIZ O QUITABARNIZ PARA MADERA
<b>GOMMA DA PNEUMATICO</b> TYRE RUBBER / CAOUTCHOUC DE PNEUMATIQUE / GUMMI / GOMA DA NEUMÁTICO	<b>SOLVENTE ORGANICO</b> ORGANIC SOLVENT / SOLVANT ORGANIQUE / ORGANISCHES LÖSEMittel / DISOLVENTE ORGANICO
<b>BIRRA - VINO</b> BEER - WINE / BIÈRE - VIN / BIER, WEIN / CERVEZA - VINO	<b>DETERGENTE ALCALINO, HD WASH PURO</b> ALKALINE DETERGENT, NEAT HD WASH / DÉTERGENT ALCALIN, HD WASH PUR / ALKALINES REINIGUNGSMittel, UNVERDÜNNTES HD WASH / DETERGENTE ALCALINO HD WASH PURO
<b>IODIO</b> IODINE / IODE / JOD / YODO	<b>AMMONIACA</b> AMMONIA / AMMONIAQUE / AMMONIAK / AMONIAC
<b>SANGUE</b> BLOOD / SANG / BLUT / SANGRE	<b>ACQUA OSSIGENATA O IPOCLORITO DI SODIO (CANDEGGINA)</b> HYDROGEN PEROXIDE OR SODIUM HYPOCHLORITE (BLEACH) / EAU OXYGÉNÉE OU HYPOCHLORITE DE SODIUM (EAU DE JAVEL) WASSERSTOFFSUPEROXID ODER NatriumHYPOCHLORIT (CHLORLAUGE) / AGUA OXIGENADA O HIPOCLORITO DE SODIO (LEJÍA)
<b>CAFFÈ, THÉ, ALIMENTI, COSMETICI, SUCCHI DI FRUTTA</b> COFFEE, TEA, FOODSTUFFS, COSMETICS, FRUIT JUICE / CAFÉ, THÉ, ALIMENTS, COSMÉTIQUE, JUS DE FRUITS KAFFEE, TEE, LEBENSMITTEL, KosMETIKA, OBSTSAFTE / CAFÉ, TÉ, ALIMENTOS, COSMÉTICOS, JUGOS DE FRUTTA	<b>COMUNE DETERSIVO IN ACQUA CALDA, POI, ACQUA OSSIGENATA O CANDEGGINA, HD WASH PURO</b> HOT WATER + NORMAL DETERGENT FOLLOWED BY HYDROGEN PEROXIDE OR BLEACH, NEAT HD WASH / DÉTERSIF COMMUN EN EAU CHAUDE, PUIS, EAU OXYGÉNÉE OU EAU DE JAVEL, HD WASH PUR / ÜBLICHES REINIGUNGSMittel IN WARME WASSER, DANN WASSERSTOFFSUPEROXID ODER CHLORLAUGE, UNVERDÜNNTES HD WASH / DETERGENTE CORRIENTE EN AGUA CALIENTE, DESPUÉS, AGUA OXIGENADA O LEJÍA HD WASH PURO
<b>INCHIOSTRO, BITUME, MERCUROCROMO</b> INK, BITUMEN, MERBROMIN, BASED ANTISEPTICS / ENCRE, BITUME, MERCUROCHROME / TINTE, BITUMEN, MERCUROCHROM / TINTA, ASFALTO, MERCROMINA	<b>SOLUZIONI DILUITE DI IPOCLORITO DI SODIO (CANDEGGINA)</b> DILUITED SODIUM HYPOCHLORITE SOLUTION (BLEACH) / SOLUTIONS DILUÉS DE HYPOCHLORITE DE SODIUM (EAU DE JAVEL) VERDÜNNTES NatriumHYPOCHLORIDLÖSUNGEN (CHLORLAUGE) / SOLUCIONES DILUIDAS DE HIPOCLORITO DE SODIO (LEJÍA)
<b>PULIZIA QUOTIDIANA</b> ROUTINE DAILY CLEANING / NETTOYAGE JOURNALIER / TÄGLICHE REINIGUNG / LIMPIEZA DIARIA	<b>NORMALI DETERGENTI DA PAVIMENTO ACQUA E ALCOOL ETILICO, HD WASH DILUITO IN ACQUA COME INDICATO</b> NORMAL FLOOR DETERGENTS, WATER + ALCOHOL, DILUITED HD WASH FOLLOWING INSTRUCTIONS / DETERGENTES USUEL POUR SOL, EAU ET ALCOOL ETHYLIQUE, HD WASH DILUE DANS LEAU COMME INDIQUE / NORMALE BODENREINIGER, WASSER UND ETHYLALKHOL, GEMÄSS ANWEISUNG IN WASSER VERDÜNNTES HD WASH / DETERGENTES CORRIENTES PARA SUELOS, AGUA Y ALCOHOL ETILICO, HD WASH DILUITO EN AGUA COMO ESTÁ INDICADO
<b>DETERGENTE A BASE ACIDA</b> ACID BASED DETERGENTS / SOLUTIONS ACIDES / SAURE REINIGUNGSMittel / DETERGENTES DE BASE ACIDA	<b>DETERGENTE A BASE ALCALINA</b> ALKALINE BASED DETERGENTS SOLUTIONS ALCALINES / ALKALINE REINIGUNGSMittel / DETERGENTES DE BASE ALCALINA
<b>ACIDO MURIATICO</b> HYDROCHLORIC ACID / ACIDE CHLORHYDRIQUE / SALZSÄURE / ACIDO MURIATICO	<b>SODA CAUSTICA</b> CAUSTIC SODA / SOUDE CAUSTIQUE / NATRON / SODA CAUSTICA
<b>ACIDO NITRICO</b> NITRIC ACID / ACIDE NITRIQUE / SALPETERSÄURE / ACIDO NITRICO	<b>POTASSA</b> POTASSIUM CARBONATE / POTASSE / POTTASCHE / POTASA
<b>ACIDO OSSALICO</b> OXALIC ACID / ACIDE OXALIQUE / OXALSÄURE / ACIDO OXÁLICO	
<b>ACIDO SOLFORICO</b> SULFURIC ACID / ACIDE SULFURIQUE / SCHWEFELSÄURE / ACIDO SULFÚRICO	

## LEVIGATO / POLISHED / POLI / POLIERT / PULIMENTADO

- Le piastrelle in CERDISASTONE levigato in opera possono presentare variazioni di tonalità, non rilevabili in precedenza.
- Le piastrelle in CERDISASTONE levigato sono tonalizzate dopo la lucidatura.
- Evitare di usare pennarelli o matite sulla superficie della piastrella in CERDISASTONE levigato.
- La superficie del CERDISASTONE levigato, se bagnata, può essere pericolosamente sdrucciolevole.
- Per facilitare la pulizia del CERDISASTONE levigato si consiglia una preventiva applicazione di LIGHT H2 fornito a richiesta dalle ceramiche CERDISA, seguendo le modalità d'uso indicate sulla confezione.
- CERDISASTONE, dopo levigatura, ha una durezza pari a 5 secondo la scala di Mohs ed è leggermente più difficile da pulire, rispetto al non levigato, qualora agenti macchianti fortemente colorati si essicchino sulla sua superficie; agendo, comunque, seguendo le indicazioni di manutenzione, e utilizzando gli opportuni pulitori o solventi, come indicato nelle pagine seguenti, e aumentando, opportunamente, i tempi del solvente indicato, si ottiene una buona pulizia del materiale stesso. Per migliorare il comportamento alle macchie del prodotto levigato e renderlo paragonabile a quello del materiale non levigato CERDISA ha studiato un trattamento specifico che viene appresso descritto. Fondamentalmente sono due i prodotti specifici per il trattamento di CERDISASTONE levigato, e un terzo è stato studiato per la sua manutenzione; i primi due sono il P100 e il LIGHT H2, il terzo è l'HD WASH. La prima operazione da eseguire per fare il trattamento è la pulizia del pavimento in modo da eliminare tutti i residui della posa: tracce di malta o collante e di stuccatura; il prodotto specifico è il P100. Il P100 è, quindi, un disincrostante da utilizzare una volta finita la posa in opera delle piastrelle. Il prodotto è un acido organico tamponato esente da acido muriatico perciò particolarmente sicuro sotto il profilo sanitario e ambientale.
- Una volta pulito il pavimento, può essere eseguito il trattamento con il LIGHT H2. Il LIGHT H2 è un prodotto idro e oleorepellente, in una parola un antimacchia da utilizzare per superfici che assorbono molto poco come quelle del gres porcellanato levigato CERDISASTONE. L'utilizzazione di questo prodotto riduce al minimo la possibilità che il CERDISASTONE levigato, una volta sporco non possa venire pulito.
- Per la manutenzione ordinaria e straordinaria può essere utilizzato l'HD WASH. L'HD WASH è un detergente concentrato attivo su qualsiasi tipo di sporco; può essere utilizzato anche con macchine lavapavimenti essendo dotato di forte potere sgrassante a formula antischiuma.

- CERDISASTONE tiles in AFTER LAYING CERDISASTONE may have variations in shade which were not noticeable previously.
- POLISHED CERDISASTONE tiles are shade-sorted after polishing.
- Do not use felt-tip pens or pencils on the surfaces of POLISHED CERDISASTONE tiles.
- If wet, the surface of POLISHED CERDISASTONE may become dangerously slippery.
- For easy cleaning of POLISHED CERDISASTONE, APPLY LIGHT H2 which is available on request from CERDISA, following the instructions on the pack.
- Smoothed CERDISASTONE surface hardness corresponds to 5 on the Mohs scale. Smoothed floors are slightly more difficult to clean with respect to the non-polished tiles when a strong colouring agent is allowed to dry on the tile surface. In this case, however, if the instructions for maintenance are followed carefully and the correct cleaning agents are used as indicated later on in these notes, it is sufficient to increase the time the particular solvent is left in contact with the area to remove stains satisfactorily. The stain resisting characteristics of polished CERDISASTONE floors may, however, be increased to the level of unpolished tiles by following the procedure outlined below, which has been specially formulated by CERDISA. There are two basic specific products for treating polished CERDISASTONE: P100 and LIGHT H2, while a third product - HD WASH - has been developed for maintenance of the floor surface. The first step is to thoroughly clean the floor with the specifically formulated P100 in order to remove all fixing residues such as traces of mortar, adhesive, and cement. P100 is a scaling agent that should be applied once the tiles have been fixed; it is an organic buffer acid which does not contain hydrochloric acid and is therefore particularly safe from a health and environmental viewpoint.
- Once the floor has been cleaned it can be treated with LIGHT H2. LIGHT H2 is both oil and water repellent, it provides protection against surface with a low absorption factor like polished CERDISASTONE stoneware. Treating a floor LIGHT H2 considerably reduces the risk of damage due to "uncleanable" stains.
- Normal and special maintenance of polished CERDISASTONE can be carried out using HD WASH. HD WASH is a concentrated detergent that removes all types of dirt and can be applied with mechanical floor washing apparatus as it combines high de-greasing power with a special nofoam formula.

- Bei verlegten polierten CERDISASTONE-Fliesen können Variationen in der Tönung auftreten, die vorher nicht wahrzunehmen waren.
- Die vorgepolierten CERDISASTONE-Fliesen werden nach der Politur getönt.
- Vorgepolierte CERDISASTONE-Fliesen dürfen nie mit Filz- oder Bleistiften beschriftet werden.
- Feuchte Oberflächen von vorgepolierten CERDISASTONE-Fliesen erweisen sich als gefährlich rutschig.
- Ein vorbeugende Behandlung des polierten CERDISASTONE mit LIGHT H2 erleichtert die Säuberung. Das Produkt kann auf Anfrage von CERDISA geliefert werden. Gebrauchsanweisungen auf der Verpackung genauestens einhalten.
- CERDISASTONE weist nach dem Schleifen eine Oberflächenhärte von 5 Mohs/Skala auf. Es ist gegenüber dem nicht geschliffenen Material etwas schwieriger zu säubern, da Fleckenmittel mit hohem Farbstoffanteil auf der Oberfläche trocknen; Die pflegeanweisungen sind deshalb zu beachten und entsprechende Reinigungs- oder Lösungsmittel, wie auf den folgenden Seiten angegeben, zu verwenden. Bei einer längeren Verweilzeit des angegebenen Lösemittels wird eine gute Reinigung erzielt. Verbesserung des Fleckenverhaltens des geschliffenen Produkts und um ein gleiches Verhalten wie jenes des nicht geschliffenen Materials zu erreichen, hat CERDISA eine spezielle Behandlungsmethode entwickelt, die nachstehend beschrieben ist. Grundlegend

sind spezifische Produkte für die Behandlung des geschliffenen CERDISASTONE vorgesehen. Ein drittes Produkt wurde für die Pflege entwickelt. Die beiden ersten Produkte sind das P100 und das LIGHT H2, das dritte Produkt das HD WASH. Die erste Phase Behandlung besteht in der Säuberung des Bodens, um alle Rückstände der Verlegung zu beseitigen: Spuren von Mörtel, Kleber oder Verlegungs-material. Das zu diesem Zweck verwendete Produkt ist das P100. Bei dem Produkt P100 handelt es sich um ein Kesselsteinlösemittel, das nach der Verlegung des Kacheln angewandt wird.

- Nachdem der Boden gesäubert ist, kann die Behandlung mit LIGHT H2 durchgeführt werden. LIGHT H2 ist ein wasser- und ölabweisendes Produkt, d.h. ein Antifleckemittel, das für Flächen mit geringer Absorption zu verwenden ist wie das geschliffene Harsteingut CERDISASTONE. Das Produkt schränkt die Möglichkeit auf Mindestmaß ein, das das geschliffene CERDISASTONE nach erfolgter Verschmutzung nicht gesäubert werden kann.
- Fue die normale Pflege von poliertem CERDISASTONE kann das Produkt HD WASH benutzt werden. HD WASH ist ein konzentriertes Reinigungsmittel, das auf fast jeder Art von Schmutz wirkt. Es kann ebenfalls mit Hilfe von Bodenreinigungsmaschinen aufgebracht werden, da es über ein hohes Entfettungsvermögen mit gleichzeitiger Schaumverminderung verfügt.
- Les carreaux en CERDISASTONE-POLI en oeuvre peuvent présenter des variations de nuances, non décelables précédemment.
- Les carreaux en CERDISASTONE-POLI sont nuancés après le polissage.
- Eviter d'utiliser des feutres ou des crayons sur la surface des carreaux en CERDISASTONE-POLI.
- Si elle est mouillée, la surface du CERDISASTONE-POLI peut être dangereusement glissante.
- Pour faciliter le nettoyage du CERDISASTONE-POLI, il est conseillé d'appliquer préalablement LIGHT H2, fourni sur demande par CERDISA, en suivant le mode d'emploi indiqué sur l'emballage.
- CERDISASTONE, après polissage, a une dureté superficielle 5 de l'échelle qualitative Mohs et est légèrement plus difficile à nettoyer que le non-poli en présence de taches fortement colorées se séchant à la surface. On ne saurait trop recommander de respecter les instructions, l'usage des nettoyeurs et/ou solvants appropriés et d'augmenter le temps de leur application pour obtenir un bon nettoyage du matériau. Pour améliorer le comportement du produit poli aux taches (et le rendre comparable à celui du non-poli), la CERDISA a développé un traitement spécifique ci-après décrit. Les produits spécifiques pour le traitement du CERDISASTONE sont foncièrement 2, et un troisième a été conçu pour sa maintenance; les deux premiers sont le P100 et le "LIGHT H2", quant au troisième il répond à l'appellation "HD WASH". Avant de procéder au traitement il y a lieu débarrasser le carrelage de tous les résidus de la pose: restes de mortier ou colle et de jointoiment; le produit spécifique est le P100. Le P100 est donc un désincrostant à utiliser après la mise en oeuvre des carreaux. Ce produit est un acide organique tamponné exempt d'acide chlorhydrique et par conséquent, répond pleinement aux normes d'hygiène et d'environnement.
- Aussitôt le carrelage nettoyé, il y a lieu de procéder au traitement avec le "LIGHT H2". Le LIGHT H2 est un produit hydrofuge (aussi étanche à l'huile), en un mot, un antitache à utiliser sur des surfaces très peu poreuses telles que le grès cérame poli CERDISASTONE. L'utilisation de ce produit élimine quasi totalement la possibilité de ne pas pouvoir nettoyer le CERDISASTONE Poli.
- Utiliser pour le maintenance ordinaire et extraordinaire de CERDISASTONE poli le "HD WASH". Le HD WASH est un détergent concentré pour tous types de sale. S'emploie par trempage avec des laveuses. Il possède un haut pouvoir solvant à formule antimosse.

- A las baldosas en CERDISASTONE PULIMENTADO, después de la pulimentación se da el tono de color.
- No use nunca rotuladores, marcadores ni lápices sobre la superficie de las baldosas en CERDISASTONE PULIMENTADO.
- Cuando está mojada, la superficie del CERDISASTONE puede resultar muy resbaladiza.
- Para facilitar la limpieza del CERDISASTONE PULIMENTADO, se aconseja aplicar previamente LIGHT H2, que la sociedad CERDISA suministra bajo pedido; para su aplicación, atégase a las instrucciones que se dan con el producto.
- CERDISASTONE, después del pulido, tiene una dureza superficial equivalente a 5 según la escala de Mohs y es más difícil de limpiar, respecto del no pulido, cuando los agentes manchadores fuertemente coloreados se seque sobre la superficie; de todas formas, siguiendo las indicaciones de mantenimiento y utilizando los adecuados productos de limpieza o disolventes, como bien se indica en las páginas sucesivas y aumentando, adecuadamente, los tiempos de contacto del disolvente indicado, se obtiene una buena limpieza del material. Para mejorar el comportamiento ante las manchas del producto pulido y hacer en modo que se pueda comparar al material no pulido CERDISA ha estudiado un tratamiento específico que describimos a continuación. Fundamentalmente son dos los productos específicos para el tratamiento de CERDISASTONE pulido, y un tercero ha sido estudiado para su mantenimiento; los dos primeros son P100 y LIGHT H2, em tercero es HD WASH. La primera operación que hay realizar para llevar a cabo el tratamiento y la limpieza del piso de manera que se eliminen todos los residuos de la colocación: restos del mortero o cola y de estucado: el producto específico es P100. P100 es, por lo tanto, un desincrostante que se utiliza una vez acabada la puesta en obra de las baldosas. El producto es un ácido orgánico tampón que carece de ácido muriático por lo que es especialmente seguro desde el punto de vista sanitario y ambiental.
- Una vez limpiado el pavimento puede llevarse a cabo el tratamiento con LIGHT H2. LIGHT H2 es un producto hidró y oleorepellente, en una palabra un quitamanchas para utilizar en superficies que absorban muy poco como las del gres porcelanado pulido CERDISASTONE. La utilización de este producto reduce al mínimo la posibilidad de que CERDISASTONE pulido una vez sucio no pueda ser limpiado.
- Para el mantenimiento ordinario y extraordinario de CERDISASTONE brillante puede utilizarse HD WASH. HD WASH es un detergente concentrado activo sobre cualquier tipo de suciedad; puede utilizarse también con máquinas lava suelos, dotado de un fuerte poder desengrasante con fórmula anti-espuma.



Caratteristica Features Características Eigenschaften Características	Unità di misura Unit of measurement Unité de mesure Masseinheit Unidad de medida	Valore medio Areatech Areatech mean value Valeur moyenne Areatech Durchschnitts-wert-Areatech Valor medio Areatech	Valore Prescritto Fixed value Valeur prescrite Vorgeschriebener wert Valor establecido	Metodo di prova Test method Méthode d'essai Prüfmethode Método de ensayo
Dimensione lati Dimensions-Lenght and widht Masse-Länge und Breite Dimensions-Longueur et largeur Dimensiones-Longitud y ancho	%	Conforme Conform Gleichmässig Conforme Conforme	+/- 0,6 MAX +/- 2,0 mm	UNI EN ISO 10545-2
Rettilineità dei lati Side straightness Geractlinigkeit der Kanten Rectitude des arêtes Rectilinedad de los lados	%	Conforme Conform Gleichmässig Conforme Conforme	+/- 0,5 MAX +/- 1,5 mm	UNI EN ISO 10545-2
Ortogonalità degli spigoli Corner squaranes Rechtwinkligkeit der Kanten Angularité Ortogonalidad de las esquinas	%	Conforme Conform Gleichmässig Conforme Conforme	+/- 0,5 MAX +/- 2,0 mm	UNI EN ISO 10545-2
Planarità Flatness Ebenflächigkeit Planéité Planeidad	%	Conforme Conform Gleichmässig Conforme Conforme	+/- 0,5 MAX +/- 2,0 mm	UNI EN ISO 10545-2
Spessore Thickness Dicke Epaisseur Grosor	%	Conforme Conform Gleichmässig Conforme Conforme	+/- 5 MAX +/- 0,5 mm	UNI EN ISO 10545-2
Assorbimento d'acqua Water absorption Wasseraufnahme Absorption d'eau Absorción de agua	%	Conforme Conform Gleichmässig Conforme Conforme	≤ 0,5	UNI EN ISO 10545-3
Resistenza all'abrasione profonda Resistance to abrasion Beständigkeit gegen oberflächenverschleiss Résistance à l'abrasion Resistencia à la abrasión	MM <sup>3</sup>	Conforme Conform Gleichmässig Conforme Conforme	≤ 175	UNI EN 10545-4
Resistenza al gelo Frost resistance Frostbeständigkeit Résistance au gel Resistencia al hielo	-	Resiste Resists Widerstandsfähig Résiste Resiste	Richiesta Request Onfrange Demande Solicitud	UNI EN ISO 10545-12
Sforzo di rottura Breaking strenght Bruchkraft Contrainte de rupture Esfuerzo de rotura	N	Conforme Conform Gleichmässig Conforme Conforme	≥ 1300 se sp ≥ 7,5 mm ≥ 700 se sp < 7,5 mm	UNI EN ISO 10545-4
Modulo di rottura Modulus of rupture Bruchmodul Coefficient de rupture Módulo de rotura	N/mm <sup>2</sup>	Conforme Conform Gleichmässig Conforme Conforme	≥ 35	UNI EN ISO 10545-4
Dilatazione termica lineare Coeff. of linear thermal expansion Linearer wärmeausdehnungs-koeffizient Coeff. d'extension thermique linéaire Coefficiente de dilatación térmica lineal	°MK (-1)	7,0	-	UNI EN ISO 10545-8
Resistenza ai prodotti chimici di uso domestico Resistance to chemicals for household use Beständigkeit gegen haushaltschemikalien Resistance aux produits d'usage domestique Resistencia a los productos químicos de uso doméstico	-	Conforme Conform Gleichmässig Conforme Conforme	UB	UNI EN ISO 10545-13
Resistenza agli sbalzi termici thermal shock resistance widerstandsfähigkeit gegen temperaturschwankungen résistance aux écarts de température resistencia al choque térmico	-	Conforme Conform Gleichmässig Conforme Conforme	Richiesta Request Onfrange Demande Solicitud	UNI EN ISO 10545-9
Stabilità dei colori Colour stability Lichtechtheit der färbung Stabilité des coloris Estabilidad de los colores	-	Resiste Resists Widerstandsfähig Résiste Resiste	Richiesta Request Onfrange Demande Solicitud	DIN 51094

	<b>Tipo di struttura</b> Structural characteristic Caractéristiques structurelles Trittsicherheitsgruppen Tipo de estructura	<b>Unità di misura</b> Unit of measurement Unité de mesure Masseinheit Unidad de medida	<b>Valore medio Areatech</b> Areatech mean value Valeur moyenne Areatech Durchschnitts-werf-Areatech Valor medio Areatech	<b>Conforme a:</b> conform to: conforme à: gemäß: conform a:
<b>Scivolosità</b> Slip factor Glätte Glissance Resbalamiento	Archistone Naturale	Gradi	A R9	DIN 51097 DIN 51130
	Archistone Grip (Darkstone/Lightstone/Pietra di Bavaria)	Gradi	A+B R10	DIN 51097 DIN 51130
	Archistone Grip (Grafito/Limestone)	Gradi	C (A+B+C) R11	DIN 51097 DIN 51130
	EC1 Naturale	Gradi	A R10	DIN 51097 DIN 51130
	EC1 Strutturato	Gradi	C (A+B+C) R12	DIN 51097 DIN 51130
	Formwork Naturale	Gradi	A R9	DIN 51097 DIN 51130
	Formwork Grip	Gradi	C (A+B+C) R11	DIN 51097 DIN 51130
	Graniti - Slate	Gradi	A R11	DIN 51097 DIN 51130
	Graniti/Tinte Unite - Trama Cross	Gradi	C R12 V4	DIN 51097 DIN 51130
	Hamada	Gradi	A+B R11	DIN 51097 DIN 51130
	Paver	Gradi	B (A+B) R 10	DIN 51097 DIN 51130
	Pietra Piasentina	Gradi	A R9	DIN 51097 DIN 51130
	Pietra Piasentina Grip	Gradi	A R10	DIN 51097 DIN 51130
	Pietraforte	Gradi	B (A+B) R 11	DIN 51097 DIN 51130
	Portland	Gradi	R9	DIN 51130
	Sandstone	Gradi	A R10	DIN 51097 DIN 51130
Stone Cult	Gradi	R9	DIN 51130	
<b>Scivolosità - Attrito asciutto</b> Slip factor - Friction on a dry surface Glätte - Rutschhemmung auf einer trockenen oberfläche Glissance - Déparage sur une surfacemouillée Resbalamiento - Fricción en seco	Archistone Grip	-	> 0,60	ASTM C 1028
	EC1 Naturale	-	> 0,60	ASTM C 1028
	EC1 Strutturato	-	> 0,60	ASTM C 1028
	Formwork Grip	-	> 0,60	ASTM C 1028
	Hamada	-	> 0,60	ASTM C 1028
	Paver	-	> 0,60	ASTM C 1028
	Pietra Piasentina	-	> 0,60	ASTM C 1028
	Pietra Piasentina	-	> 0,60	ASTM C 1028
	Pietraforte	-	> 0,60	ASTM C 1028
	Sandstone	-	> 0,60	ASTM C 1028
	Stone Cult	-	> 0,60	ASTM C 1028
<b>Scivolosità - Attrito bagnato</b> Slip factor - Friction on a wet surface Glätte - Rutschhemmung auf einer naßen fläche Glissance - Déparage sur une surfacessuyée Resbalamiento - Fricción en húmedo	Archistone Grip	-	> 0,60	ASTM C 1028
	EC1 Naturale	-	> 0,60	ASTM C 1028
	EC1 Strutturato	-	> 0,60	ASTM C 1028
	Formwork Grip	-	> 0,60	ASTM C 1028
	Hamada	-	> 0,60	ASTM C 1028
	Paver	-	> 0,60	ASTM C 1028
	Pietra Piasentina	-	> 0,60	ASTM C 1028
	Pietraforte	-	> 0,60	ASTM C 1028
	Sandstone	-	> 0,60	ASTM C 1028
	Stone Cult	-	da 0,50 a 0,60	ASTM C 1028

# PRODOTTI ANTISCIVOLO

NON-SLIP PRODUCT / RUTSCHSICHERE PRODUKTE / LES PRODUITS ANTIGLISSE / LOS PRODUCTOS ANTIDESLIZAMENTO

## SCIVOIOSITÀ secondo ASTM C 1028

Il metodo di prova statunitense ASTM C 1028 prevede la misurazione della scivolosità di un pavimento per mezzo di un test che, utilizzando uno strumento normalizzato, rileva il coefficiente statico di attrito. La prova viene eseguita con tampone in cuoio, in gomma e in neolite, con superficie asciutta e bagnata. Il risultato è valutato secondo la seguente classificazione:

inferiore a	0,50	attrito insufficiente
da	0,50 a 0,60	attrito sufficiente
superiore a	0,60	anti-slip

Nelle tabelle sono riportati solo i dati relativi al test eseguito con tampone in neolite e soltanto per quei prodotti che vengono proposti per impieghi in cui è espressamente richiesta l'antiscivolosità.

## SLIPPERINESS according to ASTM C 1028

The US testing method ASTM C 1028 measures the slipperiness of a flooring through a test that, by means of a standardized instrument, measures the static friction coefficient. The test is made with rubber, leather and neolite pads, with wet and dry surface.

The result is evaluated according to the following classification:

lower than	0,50	insufficient friction
from	0,50 a 0,60	sufficient friction
over	0,60	anti-slip

The tables show only the data relevant to the test made with neolite pad and only for those products suggested for uses where the slipping resistance is expressly recommended.

## RUTSCHGEFAHR nach ASTM C 1028

Die amerikanische Testmethode ASTM C 1028 mißt die Rutschgefahr in einem Boden über einen Test, der durch ein normalisiertes Instrument den statischen Reibungskoeffizienten ermittelt. Der Test erfolgt mit Hilfe eines Leder-, Gummi- und Neolitpuffers mit trockener und nasser Oberfläche.

Das Resultat wird nach folgender Klassifizierung bewertet:

unter	0,50	ungenügende Reibung
von	0,50 a 0,60	ausreichende Reibung
über	0,60	anti-slip

Die Tabellen enthalten nur die Daten in bezug auf den mit Neolitpuffer ausgeführten Tests für die Produkte, die nur dann eingesetzt werden, wenn ausdrückliche Rutschfestigkeit verlangt wird.

## GUSSEMENT conformément à la norme ASTM C 1028

La méthode d'essai des Etats-Unis ASTM C 1028 prévoit la mesure du glissement d'un carrelage, par un essai effectué en utilisant un instrument normalisé, qui détermine le coefficient statique de friction. L'essai est effectué à l'aide d'un tampon en cuir, d'un tampon en caoutchouc et d'un tampon en néolithe, soit pour la surface sèche, pour la surface mouillée. Le résultat est évalué sur la base du classement suivant:

moins de	0,50	friction insuffisante
de	0,50 a 0,60	friction suffisante
plus de	0,60	antiglisement

Les tableaux réportent uniquement les données concernant l'essai effectué à l'aide du tampon en néolithe et pour les seuls produits qui sont proposés pour des emplois où la caractéristique d'antiglisement est expressément demandée.

## DESIZAMIENTO según el método ASTM C 1028

El método estadounidense de prueba ASTM C 1028 prevé la medición del índice de deslizamiento de un pavimento por medio de un test que, sirviéndose de un instrumento reglamentario, determina el coeficiente de rozamiento estático del mismo. La prueba se lleva a cabo con una correa de cuero, de goma y de neolite, sobre superficie seca y mojada.

La evaluación se establece de acuerdo con la siguiente clasificación:

inferior a	0,50	roce insuficiente
da	0,50 a 0,60	roce suficiente
superior a	0,60	antideslizamiento

En las tablas se indican únicamente los datos correspondientes a la prueba efectuada con correa de neolite y sólo en referencia a los productos que se utilizan cuando se requiere de manera expresa que el pavimento sea antideslizante.

## Categoria di resistenza allo scivolamenti con piedi calzati

Slip resistance group with footwear

Categories de resistance au glissement les pieds chaussés

Rutschhemmungskategorien mit schuhwerk

Categoría de resistencia al resbalamiento con zapatos en los pies

## ZH1/571 - DIN 51130

SUPERFICIE DI CALPESTIO  
SURFACE TO WALK ON - SURFACE DE PIÉTINEMENT  
TRITTFÄCHE - SUPERFICIE DE TRAFICO PEATONAL

SPAZIO DI RACCOLTA  
COLLECTION SPACE - ESPACE DE RÉCUPÉRATION  
VERDRÄNGUNGSRAUM - ESPACIO DE RECÓGIDA

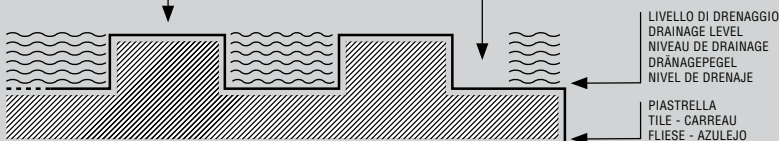

CONTRASSEGNO DELLO SPAZIO DI RACCOLTA  
COLLECTION SPACE MARK  
IDENTIFICATION DE L'ESPACE DE RÉCUPÉRATION  
KENNZAHL FÜR VERDRÄNGUNGSRAUM  
MARCA DE IDENTIFICACION DEL ESPACIO DE RECÓGIDA

VOLUME MIN. DELLO SPAZIO DI RACCOLTA (CM³/DM²)  
MIN. VOLUME OF COLLECTION SPACE (CM³/DM²)  
VOLUME MIN. DE L'ESPACE DE RÉCUPÉRATION (CM³/DM²)  
MINDESTVOLUMEN VERDRÄNGUNGSRAUMES (CM³/DM²)  
VOLUMEN DEL ESPACIO DE RECÓGIDA (CM³/DM²)

V4	→	4
V6	→	6
V8	→	8
V10	→	10

COEFFICIENTE DI ATTRITO  
COEFFICIENT OF FRICTION  
COEFFICIENT DE FRICTION  
REIBUNGSKOEFFIZIENT  
COEFICIENTE DE FRICCIÓN

ANGOLI DI INCLINAZIONE  
ANGLE  
ANGLE D'INCLINAISON  
NEIGUNGSWINKEL  
ÁNGULOS DE INCLINACIÓN

CAMPI DI APPLICAZIONE  
FIELD OF APPLICATION  
DOMAINES D'UTILISATION  
ANWENDUNGSBEREICH  
CAMPOS DE APLICACIÓN

R9		6° ÷ 10°	AMBIENTI RESIDENZIALI, SCUOLE, STUDI MEDICI, ECC. - RESIDENTIAL ENVIRONMENTS, SCHOOLS, SURGERIES, ETC. - MILIEUX RÉSIDENTIELS, ÉCOLES, CABINETS DE MÉDECINS, ETC. - WOHNBEREICH, SCHULEN, ARZTPRAXEN USW. - AMBIENTES RESIDENCIALES, ESCUELAS, SERVICIOS MÉDICOS, ETC.
R10		10° ÷ 19°	TOILETTES, MAGAZZINI, GARAGES, CUCINE DI LOCALI PUBBLICI ECC. - BATHROOMS, WAREHOUSES, GARAGES, KITCHENS OF RESTAURANT, ETC. - TOILETTES, MAGASINS, GARAGES, CUISINES D'ÉTABLISSEMENTS PUBLICS, ETC. - TOILETTEN, LAGERHALLEN, GARAGEN, GROBKÜCHEN USW. - RETRETES, ALMACENES, GARAJES, COCINAS, LOCALES PÚBLICOS, ETC.
R11		19° ÷ 27°	LAVORAZIONE FORMAGGI, CELLE FRIGORIFERE, LAVANDERIE, ECC. - DAIRIES, COLD ROOMS, LAUNDRIES, ETC. - TRAVAIL DU FROMAGE, CHAMBRES FRIGORIFIQUES, BLANCHISSERIES, ETC. - KÄSEREI, WÄSCHEREI, KÜHLRÄUME, USW. TRANSFORMACIÓN QUESOS, CELDAS FRIGORÍFICAS, LAVANDERÍAS, ETC.
R12		27° ÷ 35°	LAVORAZIONE CARNI, CUCINE INDUSTRIALI, ZUCCHERIFICI, ECC. - MEAT PROCESSING, INDUSTRIAL KITCHENS, SUGAR PRODUCTION, ETC. - TRAVAIL DE LA VIANDE, CUISINES INDUSTRIELLES, SUCRERIES, ETC. - FLEISCHVERARBEITUNGSTÄTTEN, INDUSTRIEKÜCHEN, ZUCKERFABRIKEN, USW. - TRANSFORMACIÓN CARNES, COCINAS INDUSTRIALES, AZUCARERÍAS, ETC.

## Pavimentazioni per zone bagnate con calpestio a piedi scalzi



Slip proof products flooring for wet areas used when barefoot

Sols pour zones mouillées de cheminement pieds nus

Für Böden in Nassbereichen mit barfußbegehung

Pavimentaciones para zonas mojadas con tráfico peatonal con pies descalzos

### GUV. 26.17 - DIN 51097

GRUPPO DI CLASSIFICAZIONE EVALUATION GROUP GROUPE D'EVALUATION BEWERTUNGSGRUPPE GRUPOS DE EVALUACION	ANGOLO MINIMO DI INCLINAZIONE MINIMUM ANGLE OF SLOPE ANGLE MIN. D'INCLINAISON MINIMALER NEIGUNGSWINKEL ANGULO MÍNIMO DE INCLINACION
<b>A</b>	→ ≥12° 
<b>B</b>	→ ≥18° 
<b>C</b>	→ ≥24° 

GRUPE D'EVALUATION	ANGLE MIN. D'INCLINAISON	LISTE DES ZONES MOUILLÉES AVEC PIÉTINEMENT PIEDS NUS
<b>A</b>	<b>12°</b>	<ul style="list-style-type: none"> <li>- COULOIRS DE CHEMINEMENT PIEDS NUS (LE PLUS SOUVENT SEC)</li> <li>- VESTIAIRES INDIVIDUELS OU DE GROUPE</li> <li>- FONDOS DE PISCINES BASSES, AVEC TOUTE LA PROFONDEUR NE DÉPASSANT PAS 80 CM.</li> </ul>
<b>B</b>	<b>18°</b>	<ul style="list-style-type: none"> <li>- COULOIRS DE CHEMINEMENT PIEDS NUS NE FAISANT PAS PARTIE DE LA CATÉGORIE A</li> <li>- DOUCHES</li> <li>- ZONES D'INSTALLATION DE VAPORISATION DE DÉSINFECTANTS</li> <li>- PASSAGE AUTOUR DES PISCINES</li> <li>- FONDOS DE PISCINES BASSES, AVEC UNE PROFONDEUR INFÉRIEURE À 80 CM EN CERTAINS POINTS</li> <li>- FONDOS DU BASSIN DANS LES PISCINES BASSES À VAGUES</li> <li>- PLANS DE SOULÈVEMENT</li> <li>- PISCINES POUR ENFANTS</li> <li>- ÉCHELLES MURALES D'ENTRÉE DANS L'EAU</li> <li>- ESCALIERS D'ENTRÉE DANS L'EAU D'UNE LARGEUR D'1M MAX. AVEC RAMPE DES DEUX CÔTÉS</li> <li>- ÉCHELLES ET ESCALIERS SITUÉS À L'EXTÉRIEUR DE LA ZONE DU BASSIN</li> </ul>
<b>C</b>	<b>24°</b>	<ul style="list-style-type: none"> <li>- ESCALIERS D'ENTRÉE DANS L'EAU NE FAISANT PAS PARTIE DE LA CATÉGORIE B</li> <li>- BASSINS DE PASSAGE</li> <li>- BORD DE PISCINE INCLINÉ</li> </ul>

GRUPO DE EVALUACION	ANGULO MÍNIMO DE INCLINACION	ELENCO DE LA ZONAS MOJADAS CON TRAFICO PEATONAL CON PIES DESCALZOS
<b>A</b>	<b>12°</b>	<ul style="list-style-type: none"> <li>- PASILLOS PARA TRÁFICO PEATONAL CON PIES DESCALZOS (LA MAYORÍA SECOS)</li> <li>- VESTUARIOS INDIVIDUALES O DE GRUPO</li> <li>- FONDOS DE PISCINAS BAJAS, CUANDO EN TODA LA PISCINA LA PROFUNDIDAD NO SUPERA LOS 80 CM.</li> </ul>
<b>B</b>	<b>18°</b>	<ul style="list-style-type: none"> <li>- PASILLOS PARA EL TRÁFICO PEATONAL CON PIES DESCALZOS QUE NO FORMAN PARTE DE LA CATEGORÍA A</li> <li>- DUCHAS</li> <li>- ZONAS DE INSTALACIONES DE PULVERIZACIÓN DE DESINFECTANTES</li> <li>- PASO ALREDEDOR DE LA PISCINA</li> <li>- FONDOS DE PISCINAS BAJAS CUANDO EN DETERMINADOS PUNTOS DE LA PISCINA LA PROFUNDIDAD DEL AGUA ES INFERIOR A 80 CM.</li> <li>- FONDOS DE PISCINAS BAJAS CON OLAS</li> <li>- PLANOS DE ELEVACION</li> <li>- PISCINAS PARA NIÑOS</li> <li>- ESCALERAS DE MANO QUE LLEVAN AL AGUA</li> <li>- ESCALERAS QUE LLEVAN AL AGUA CON UNA ANCHURA MÁX. DE 1 M. CON BARANDILLAS EN AMBOS LADOS</li> <li>- ESCALERAS DE MANO Y ESCALERAS EN EL EXTERIOR DE LA ZONA DE LA PISCINA</li> </ul>
<b>C</b>	<b>24°</b>	<ul style="list-style-type: none"> <li>- ESCALERAS QUE LLEVAN AL AGUA QUE NO FORMAN PARTE DE LA CATEGORÍA B</li> <li>- PISCINAS DE PASO</li> <li>- BORDE DE PISCINA INCLINADO</li> </ul>

GRUPPO DI VALUTAZIONE	ANGOLO MIN. DI INCLINAZIONE	ELENCO DELLE ZONE BAGNATE CON CALPESTIO A PIEDI SCALZI
<b>A</b>	<b>12°</b>	<ul style="list-style-type: none"> <li>- CORRIDOI PER CALPESTIO CON PIEDI SCALZI (PER LO PIÙ SECCHI)</li> <li>- SPOGLIATOI SINGOLI O DI GRUPPO</li> <li>- FONDI DI PISCINE BASSE, QUANDO IN TUTTA LA PISCINA LA PROFONDITÀ NON SUPERA GLI 80 CM.</li> </ul>
<b>B</b>	<b>18°</b>	<ul style="list-style-type: none"> <li>- CORRIDOI PER CALPESTIO CON PIEDI SCALZI NON FACENTI PARTE DELLA CATEGORIA A</li> <li>- DOCCE</li> <li>- ZONE DI IMPIANTI DI SPRIZZATURA DI DISINFETTANTI</li> <li>- PASSAGGIO INTORNO ALLE PISCINE</li> <li>- FONDI DI PISCINE BASSE, QUANDO IN DETERMINATI PUNTI DELLA VASCA LA PROFONDITÀ DELL'ACQUA È INFERIORE A 80 CM.</li> <li>- FONDI DI VASCHE IN PISCINE BASSE A ONDE</li> <li>- PIANI DI SOLLEVAMENTO</li> <li>- PISCINE PER BAMBINI</li> <li>- SCALE A PIOLI CHE PORTANO IN ACQUA</li> <li>- SCALE CHE PORTANO IN ACQUA CON LARGHEZZA MAX DI 1 M. CON CORRIMANO SU ENTRAMBI I LATI</li> <li>- SCALE A PIOLI E SCALE ALL'ESTERNO DELLA ZONA DELLA VASCA</li> </ul>
<b>C</b>	<b>24°</b>	<ul style="list-style-type: none"> <li>- SCALE CHE PORTANO IN ACQUA NON FACENTI PARTE DELLA CATEGORIA B</li> <li>- VASCHE PER PASSAGGIO</li> <li>- BORDO PISCINA INCLINATO</li> </ul>

EVALUATION GROUP	MIN. ANGLE OF SLOPE	LIST OF WET AREAS TO BE WALKED ON BAREFOOT
<b>A</b>	<b>12°</b>	<ul style="list-style-type: none"> <li>- CORRIDORS USED WHEN BAREFOOT (GENERALLY WHEN DRY)</li> <li>- SINGLE OR GROUP CHANGING ROOMS</li> <li>- BOTTOMS OF SHALLOW SWIMMING POOLS, WHEN THE DEPTH DOES NOT EXCEED 80 CM. IN THE ENTIRE SWIMMING POOL</li> </ul>
<b>B</b>	<b>18°</b>	<ul style="list-style-type: none"> <li>- CORRIDORS USED WHEN BAREFOOT, NOT COVERED BY CATEGORY A</li> <li>- SHOWERS</li> <li>- AREAS WITH SYSTEMS FOR SPRAYING DISINFECTANT</li> <li>- AREAS AROUND THE SWIMMING POOL</li> <li>- BOTTOMS OF SHALLOW SWIMMING POOLS WHEN THE DEPTH OF THE WATER IS LESS THAN 80 CM. AT CERTAIN POINTS IN THE POOL</li> <li>- BOTTOMS OF SHALLOW SWIMMING POOLS WITH WAVE MACHINE</li> <li>- PLATFORMS</li> <li>- BABY POOLS</li> <li>- LADDERS LEADING INTO WATER</li> <li>- STEPS LEADING INTO WATER WITH A MAX. WIDTH OF 1 M. WITH A HANDRAIL ON BOTH SIDES</li> <li>- LADDERS AND STEPS OUTSIDE THE POOL AREA</li> <li>- LADDERS LEADING INTO WATER NOT COVERED BY CATEGORY B</li> <li>- WALK THROUGH POOLS</li> <li>- SLOPING EDGES OF SWIMMING POOLS</li> </ul>
<b>C</b>	<b>24°</b>	<ul style="list-style-type: none"> <li>- LADDERS LEADING INTO WATER NOT COVERED BY CATEGORY B</li> <li>- WALK THROUGH POOLS</li> <li>- SLOPING EDGES OF SWIMMING POOLS</li> </ul>

BEWERTUNGSGRUPPE	MINDEST-NEIGUNGSWINKEL	RUTSCHHEMMUNG IN BARFUSSBEREICHEN
<b>A</b>	<b>12°</b>	<ul style="list-style-type: none"> <li>- BARFUSSGÄNGE (WEITGEHEND TROCKEN)</li> <li>- EINZEL-UND SAMMELUMKLEIDERÄUME</li> <li>- BECKENBÖDEN IN NICHTSCHWIMMERBEREICHEN, WENN IM GESAMTEN BEREICH DIE WASSERTIEFE NICHT MEHR ALS 80 CM. BETRÄGT</li> </ul>
<b>B</b>	<b>18°</b>	<ul style="list-style-type: none"> <li>- BARFUSSGÄNGE, SOWEIT SIE NICHT A ZUGEORDNET SIND</li> <li>- DUSCHRÄUME</li> <li>- BEREICHE VON DESINFIZIATIONSSPRÜHANLAGEN</li> <li>- BECKENRANDUMGEBUNGEN</li> <li>- BECKENBÖDEN IN NICHTSCHWIMMERBEREICHEN, WENN IN TEILBEREICHEN DIE WASSERTIEFE WENIGER ALS 80 CM. BETRÄGT</li> <li>- BECKENBÖDEN IN NICHTSCHWIMMERBEREICHEN VON WELLENBÄDERN</li> <li>- HUBBÖDEN</li> <li>- KINDERPLANSCHBECKEN</li> <li>- INS WASSER FÜHRENDE SPROSSENLEITERN</li> <li>- INS WASSER FÜHRENDE, MAX. 1 M. BREITE TREPPEN MIT BEIDSEITIGEN HANDLÄUFEN</li> <li>- SPROSSENLEITERN UND TREPPEN AUSSERHALB DES BECKENBEREICHES</li> </ul>
<b>C</b>	<b>24°</b>	<ul style="list-style-type: none"> <li>- INS WASSER FÜHRENDE TREPPEN, SOWEIT SIE NICHT B ZUGEORDNET SIND</li> <li>- DURCHGANGSBECKEN</li> <li>- GENEIGTE BECKENRANDAUSBILDUNGEN</li> </ul>

# CERDISASTONE

**Gres porcellanato colorato in massa EN 14411 Bla** / Colorbody porcelain stoneware / Durhgefärbtes steinzeug  
Grès cérame coloré dans le masse / Gres porcelánico coloreado en toda la masa

Caratteristica Features Características Eigenschaften Características	Unità di misura Unit of measurement Unité de mesure Masseinheit Unidad de medida	Valore medio Cerdisa Cerdisa mean value Valeur moyenne Cerdisa Durchschnitts-wert-Cerdisa Valor medio Cerdisa	Valore Prescritto Fixed value Valeur prescrite Vorgeschriebener wert Valor establecido	Metodo di prova Test method Méthode d'essai Prüfmethode Método de ensayo
Dimensione lati Dimensions-Lenght and widht Masse-Länge und Breite Dimensions-Longueur et largeur Dimensiones-Longitud y ancho	%	Conforme Conform Gleichmässig Conforme Conforme	+/- 0,6 MAX +/- 2,0 mm	UNI EN ISO 10545-2
Rettilineità dei lati Side straightness Geractlinigkeit der Kanten Rectitude des arêtes Rectilinedad de los lados	%	Conforme Conform Gleichmässig Conforme Conforme	+/- 0,5 MAX +/- 1,5 mm	UNI EN ISO 10545-2
Ortogonalità degli spigoli Corner squaranness Rechtwinkligkeit der Kanten Angularité Ortogonalidad de las esquinas	%	Conforme Conform Gleichmässig Conforme Conforme	+/- 0,5 MAX +/- 2,0 mm	UNI EN ISO 10545-2
Planarità Flatness Ebenflächigkeit Planéité Planeidad	%	Conforme Conform Gleichmässig Conforme Conforme	+/- 0,5 MAX +/- 2,0 mm	UNI EN ISO 10545-2
Spessore Thickness Dicke Epaisseur Grosor	%	Conforme Conform Gleichmässig Conforme Conforme	+/- 5 MAX +/- 0,5 mm	UNI EN ISO 10545-2
Assorbimento d'acqua Water absorption Wasseraufnahme Absorption d'eau Absorción de agua	%	Conforme Conform Gleichmässig Conforme Conforme	≤ 0,5	UNI EN ISO 10545-3
Storzo di rottura Breaking strenght Bruchkraft Contrainte de rupture Estuerzo de rotura	N	Conforme Conform Gleichmässig Conforme Conforme	≥ 1300 se sp ≥ 7,5 mm ≥ 700 se sp < 7,5 mm	UNI EN ISO 10545-4
Modulo di rottura Modulus of rupture Bruchmodul Coefficient de rupture Módulo de rotura	N/mm <sup>2</sup>	Conforme Conform Gleichmässig Conforme Conforme	≥ 35	UNI EN ISO 10545-4
Resistenza alle macchie Stain resistant Flecken beständigkeit Résistance au tâches Resistencia a las manchas	-	Conforme Conform Gleichmässig Conforme Conforme	3	UNI EN ISO 10545-14
Resistenza ai prodotti chimici di uso domestico Resistance to chemicals for household use Beständigkeit gegen haushaltschemikalien Resistance aux produits d'usage domestique Resistencia a los productos químicos de uso doméstico	-	Conforme Conform Gleichmässig Conforme Conforme	B MIN	UNI EN ISO 10545-13

# CERDISAWHITE / WALL

Rivestimento in pasta bianca rettificato BIII EN 14411 / White clay wall tiles rectified / Weisscherbige wandfliesen kalibriert  
Revêtement mural en pâte blanche rectifiée / Revestimientos en pasta blanca rectificado

Rivestimento in bicottura - Monoporosa B III EN 14411 / Double fired wall tiles - Monoporosa / Wandfliesen - Zweibrandverfahren - Monoporosa  
Revêtement mural - Bicuissou - Monoporosa / Revestimientos - Bicoccción - Monoporosa

Caratteristica Features Caracteristiques Eigenschaften Características	Unità di misura Unit of measurement Unité de mesure Masseinheit Unidad de medida	Valore medio Cerdisa Cerdisa mean value Valeur moyenne Cerdisa Durchschnitts-wert-Cerdisa Valor medio Cerdisa	Valore Prescritto Fixed value Valeur prescrite Vorgeschriebener wert Valor establecido	Metodo di prova Test method Méthode d'essai Prüfmethode Método de ensayo
Dimensione lati Dimensions-Lenght and widht Masse-Länge und Breite Dimensions-Longueur et largeur Dimensiones-Longitud y ancho	%	Conforme Conform Gleichmässig Conforme Conforme	+/- 0,5 MAX +/-2,0 mm	UNI EN ISO 10545-2
Rettilineità dei lati Side straightness Geractlinigkeit der Kanten Rectitude des arêtes Rectilinedad de los lados	%	Conforme Conform Gleichmässig Conforme Conforme	+/- 0,3 MAX +/- 1,5 mm	UNI EN ISO 10545-2
Ortogonalità degli spigoli Corner squaranness Rechtwinkligkeit der Kanten Angularité Ortogonalidad de las esquinas	%	Conforme Conform Gleichmässig Conforme Conforme	+/- 0,5 MAX +/- 2,0 mm	UNI EN ISO 10545-2
Planarità - Curvatura del centro in rapporto alla diagonale Flatness - Curvature at center vs. diagonal Ebenfächigkeit - Krümmung in der Mitte bei diagonaler Messung Planéité - Courbure du centre par rapport à la diagonale Planeidad	%	Conforme Conform Gleichmässig Conforme Conforme	+ 0,5 / - 0,3 + 2,0 mm / - 1,5 mm	UNI EN ISO 10545-2
Planarità - Curvatura dello spigolo in rapporto alla lunghezza Flatness - Curvature of edges vs. lenght Ebenfächigkeit - Krümmung der Kanten im Verhältnis zur Länge Planéité - Courbure de l'arete par rapport a la longueur Planeidad	%	Conforme Conform Gleichmässig Conforme Conforme	+ 0,5 / - 0,3 + 2,0 mm / - 1,5 mm	UNI EN ISO 10545-2
Planarità - Svergolatura in rapporto alla diagonale Flatness - Twisting vs. diagonal Ebenfächigkeit - im Verhältnis zur diagonalen Verziehung Planéité - Gauchissement par rapport à la diagonale Planeidad	%	Conforme Conform Gleichmässig Conforme Conforme	+ 0,5 MAX +/- 2,0 mm	UNI EN ISO 10545-2
Spessore Thickness Dicke Epaisseur Grosor	%	Conforme Conform Gleichmässig Conforme Conforme	+/- 10 MAX +/- 0,5 mm	UNI EN ISO 10545-2
Assorbimento d'acqua Water absorption Wasseraufnahme Absorption d'eau Absorción de agua	%	Conforme Conform Gleichmässig Conforme Conforme	> 10	UNI EN ISO 10545-3
Sforzo di rottura Breaking strenght Bruchkraft Contrainte de rupture Estuerzo de rotura	N	Conforme Conform Gleichmässig Conforme Conforme	≥ 600 se sp ≥ 7,5 mm ≥ 200 se sp < 7,5 mm	UNI EN ISO 10545-4
Modulo di rottura Modulus of rupture Bruchmodul Coefficient de rupture Módulo de rotura	N/mm2	Conforme Conform Gleichmässig Conforme Conforme	≥ 15 se sp ≥ 7,5 mm ≥ 12 se sp < 7,5 mm	UNI EN ISO 10545-4
Resistenza al cavillo Crazing resistant Haarisse Résistance aux tréssaillures Resistencia al quarteado	-	Resiste Resists Widerstandsfähig Résiste Resiste	Richiesta Request Onfrange Demande Solicitud	UNI EN ISO 10545-11
Resistenza alle macchie Stain resistant Flecken beständigkeit Résistance au tâches Resistencia a las manchas	-	Conforme Conform Gleichmässig Conforme Conforme	3MIN	UNI EN ISO 10545-14
Resistenza ai prodotti chimici di uso domestico Resistance to chemicals for household use Beständigkeit gegen haushaltschemikalien Resistance aux produits d'usage domestique Resistencia a los productos químicos de uso doméstico	-	Conforme Conform Gleichmässig Conforme Conforme	GB	UNI EN ISO 10545-13

Project coordinator: Cerdisa Marketing DPT.



Uffici commerciali:  
Via Statale, n° 99/D  
42013 Dinazzano di Casalgrande - RE  
Tel. +39 0522 773.611  
Fax +39 0522 773.659/60  
[www.ceramichecerdisa.it](http://www.ceramichecerdisa.it)  
[marketing@cerdisa.biz](mailto:marketing@cerdisa.biz)