

NOVACRONO

GIUGIARO
D E S I G N



mosaico+





NOVACRONO

GIUGIARO
DESIGN
mosaico+

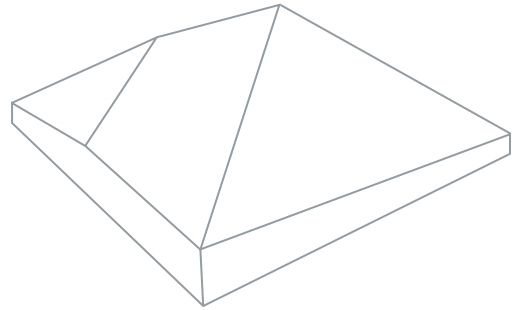
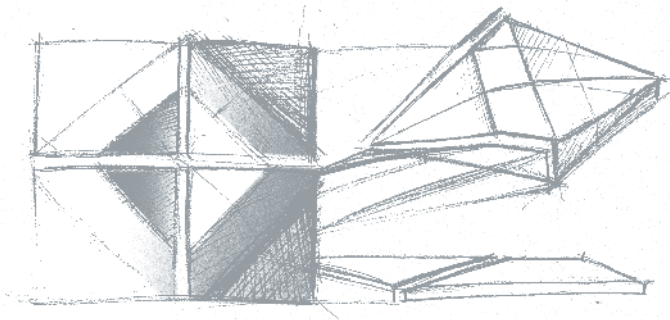

energia e piani prospettici, l'intuizione che sorprende
energy and perspective planes, intuition is surprising



NOVACRONO

GIUGIARO
DESIGN
mosaico+



Bianco*



Grigio C.*



Grigio S.*



Nero*



Beige*



Rosso*



Azzurro*



Blu*



Viola*



Petrolio*

*Layout Nova 1

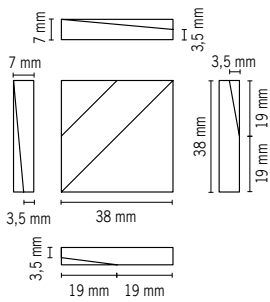

NOVA 1

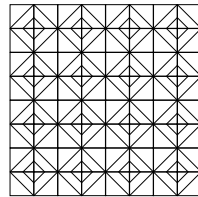

320x320 mm 12^{1/2}x 12^{1/2}"

38x38 mm
1^{1/2}x1^{1/2}"

NOVA 2

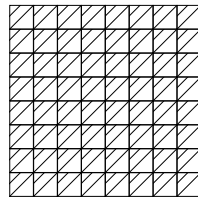

320x320 mm 12^{1/2}x 12^{1/2}"

38x38 mm
1^{1/2}x1^{1/2}"

NOVA 3

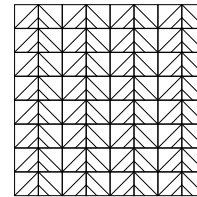

320x320 mm 12^{1/2}x 12^{1/2}"

38x38 mm
1^{1/2}x1^{1/2}"

NOVA 4

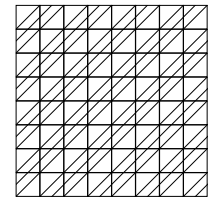

320x320 mm 12^{1/2}x 12^{1/2}"

38x38 mm
1^{1/2}x1^{1/2}"

CARATTERISTICHE TECNICHE TECHNICAL CHARACTERISTICS

Assorbimento d'acqua Water absorption (UNI EN ISO 10545/3)	Resistenza al gelo Frost resistance (UNI EN ISO 10545/12)	Resistenza agli attacchi chimici Resistance to chemical attacks (UNI EN ISO 10545/13)	Resistenza alle macchie Resistance to staining (UNI EN ISO 10545/14)	Resistenza dei colori alla luce Colours resistance to fading (DIN 51094)	Ricerca di piombo e cadmio Lead and cadmium reserch (UNI EN ISO 10545/15)	Resistenza all'impatto Impact strength (UNI EN ISO 10545/5)	Resistenza all'abrasione profonda Resistance to deep abrasion (UNI EN ISO 10545/6)
nullo / none	resistente / resistant	resistente / resistant	resistente / resistant	resistente / resistant	assente / absent	0,83	165 mm ³
Intensity of Cohesion of the Ceramic Floor tiles to the Portland Concrete ASTM C482-02		Crazing Resistance ASTM C424-93	Resistance to Frost/Defrost Cycles ASTM C1026-87		Water Absorption ASTM C373-88	Resistance to Abrasion ASTM C1027-99	
>50 psi		passes	passes		passes	3	

IMBALLI PACKAGING

Layout	Misure / Tessera mm inches Chip / Size mm inches	Misure / Foglio mm inches Sheet / Size mm inches	Fogli / Scatola Sheets / Box	m ² Sq ft / Scatola Sqm. Sq ft / Box
Nova 1				
Nova 2				
Nova 3	38x38 mm 1 ^{1/2} x1 ^{1/2} "	320x320 mm 12 ^{1/2} x12 ^{1/2} "	10	1,02 10,98
Nova 4				

ogni layout può venire realizzato sia in tinta unita (10 colori a disposizione) che a colori miscelati / each layout can be created using both solid colours (10 colours available) and mixed colours

PULSARCRONO

GIUGIARO
D E S I G N



mosaico+

PULSARCRONO

GIUGIARO
DESIGN
mosaico+

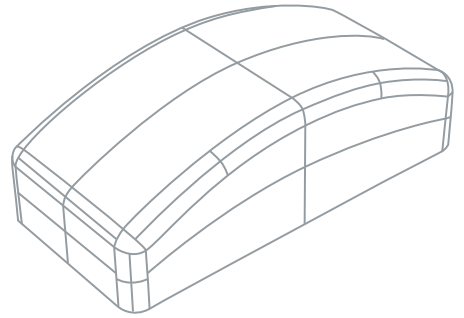
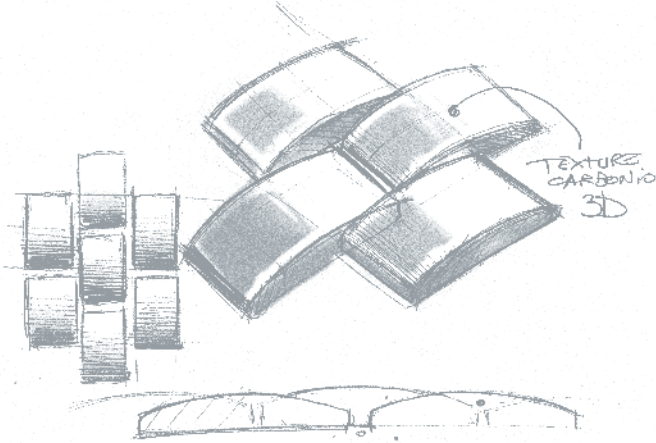

un impulso, una traiettoria, una raffinata forma filante
an impulse, a trajectory, a refined, streamlined shape







PULSARCRONO

GIUGIARO
DESIGN
mosaico+



Bianco*



Grigio C.*



Grigio S.*



Nero*



Beige*



Rosso*



Azzurro*



Blu*



Viola*



Petrolio*

*Layout Pulsar 2

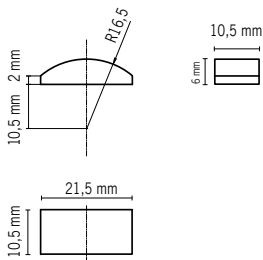

PULSAR 1

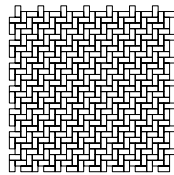

312x312 mm 12^{1/4}x 12^{1/4}"

□ 21,5x10,5 mm
7/8x3/8"

PULSAR 2

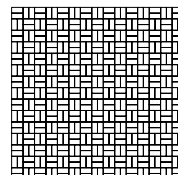

323x323 mm 12^{3/4}x 12^{3/4}"

□ 21,5x10,5 mm
7/8x3/8"

PULSAR 3

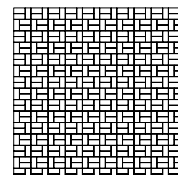

323x323 mm 12^{3/4}x 12^{3/4}"

□ 21,5x10,5 mm
7/8x3/8"

PULSAR 4

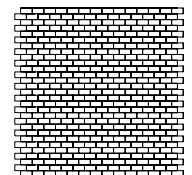

316x327 mm 12^{1/2}x 12^{7/8}"

□ 21,5x10,5 mm
7/8x3/8"

CARATTERISTICHE TECNICHE TECHNICAL CHARACTERISTICS

Assorbimento d'acqua Water absorption (UNI EN ISO 10545/3)	Resistenza al gelo Frost resistance (UNI EN ISO 10545/12)	Resistenza agli attacchi chimici Resistance to chemical attacks (UNI EN ISO 10545/13)	Resistenza alle macchie Resistance to staining (UNI EN ISO 10545/14)	Resistenza dei colori alla luce Colours resistance to fading (DIN 51094)	Ricerca di piombo e cadmio Lead and cadmium reserch (UNI EN ISO 10545/15)	Resistenza all'impatto Impact strength (UNI EN ISO 10545/5)	Resistenza all'abrasione profonda Resistance to deep abrasion (UNI EN ISO 10545/6)
nullo / none	resistente / resistant	resistente / resistant	resistente / resistant	resistente / resistant	assente / absent	0,83	165 mm ³
Intensity of Cohesion of the Ceramic Floor tiles to the Portland Concrete ASTM C482-02	Crazing Resistance ASTM C424-93	Resistance to Frost/Defrost Cycles ASTM C1026-87	Water Absorption ASTM C373-88	Resistance to Abrasion ASTM C1027-99			
>50 psi	passes	passes	passes	3			

IMBALLI PACKAGING

Layout	Misure / Tessera mm inches Chip / Size mm inches	Misure / Foglio mm inches Sheet / Size mm inches	Fogli / Scatola Sheets / Box	m ² Sq ft / Scatola Sqm. Sq ft / Box
Pulsar 1		312x312 mm 12 ^{1/4} x 12 ^{1/4} "		0,97 10,44
Pulsar 2	21,5x10,5 mm 7/8x3/8"	323x323 mm 12 ^{3/4} x 12 ^{3/4} "	10	1,04 11,19
Pulsar 3		316x327 mm 12 ^{1/2} x 12 ^{7/8} "		1,03 11,09

ogni layout può venire realizzato sia in tinta unita (10 colori a disposizione) che a colori miscelati / each layout can be created using both solid colours (10 colours available) and mixed colours