

**ECOLOGY  
IS  
THE  
NEW  
MUST**

**bongio**  
DAL 1936



bongio



Guardare al futuro con la consapevolezza di chi ha storia nel passato: Bongio produce collezioni di rubinetti ed accessori di arredo per il bagno dal 1936. Qualità, design, ricerca ed innovazione sono i principi fondamentali su cui si basa tutta la progettazione e la produzione. Lavorazioni artigianali, amore per la tecnica, materiali pregiati e finiture completamente realizzate e controllate in azienda, garantiscono un elevato standard qualitativo e rendono ogni singolo articolo un vero e proprio oggetto d'arredamento. Con una produzione che per il 60% è ormai destinata ai più esigenti mercati esteri, Bongio si è conquistata un ruolo di prestigio nella vetrina internazionale ove il design italiano è da sempre considerato il top del buon gusto e dell'eleganza. Grazie a oltre sessant'anni di esperienza ed alla collaborazione con designer Bongio è riuscita a conferire al bagno quella personalità, quel carattere che lo spazio 'intimo' per eccellenza della casa si merita.

*Looking to the future with the knowledge of the past: Bongio has been producing tap and bathroom fitting collections since 1936. Quality, design, research and innovation are the basis for all the planning and production. High standards are guaranteed by the craftsmanship, love for technology, quality materials, and the products being finished and checked by the company. Every single item really furnishes the bathroom. 60% of the production is destined for the most demanding foreign markets - Bongio has won a prestigious place the world over, where Italian design has always been considered the number one for good taste and elegance. Thanks to more than sixty years of experience and working together with the architects and designers Bongio gives the bathroom that personality and character that the most intimate room in the house deserves.*



L'acqua non è finita  
ma non è infinita...

In un'epoca come la nostra, dove l'acqua sta diventando un bene sempre più prezioso, bongio promuove l'iniziativa "I LOVE WATER", volendo sensibilizzare alla cultura del risparmio d'acqua quale bene fondamentale e insostituibile. È in linea con questa filosofia, che bongio ha attivato una serie di interventi mirati. A partire da Aprile 2008, tutti i rubinetti, verranno forniti di un dispositivo atto a ridurre la portata d'acqua, senza precluderne i scenografici effetti ma garantendo un sostanziale risparmio sia economico che energetico, il tutto senza alcuna maggiorazione ai prezzi in corso. Inoltre in continuità con questo indirizzo, bongio sosterrà un progetto idrico per la costruzione di pozzi d'acqua per le popolazioni Africane finanziando l'associazione AMREF. Siamo sicuri che i clienti storici e quelli futuri, apprezzeranno questa scelta. Per essere aggiornati su tutti gli aspetti: [www.bongio.it](http://www.bongio.it)

**I Love Water®**



During a century, like our one, where the water is becoming a precious good, bongio promotes the campaign "I LOVE WATER", wishing to push the culture of the water's saving as a fundamental and unreplaceable good. It is to follow this philosophy, that bongio has started a serie of particular actions.

From April 2008, all the bongio mixers will have a particular device that will reduce the flow of the water without limiting the functionality and the design, but granting to have an important energetic and economic save.

All this without any increase on the current prices.

Moreover following the same philosophy, bongio will support a water project to build new wells of water for the African population, financing the AMREF Association, believing that also our historical customers and the new ones can appreciate the choice. To be updating about the initiative, please visit our web site: [www.bongio.it](http://www.bongio.it)

**bongio**  
DAL 1936





# Indice

Soffi.....	09
Riva - Riva HT.....	37
Acquaviva.....	49
O'clock.....	73
Elettonici.....	87
Stelth.....	93
Crystal.....	105
Myamyx.....	113
Domino.....	129
Grip.....	139
One - Mini One.....	151
Moon.....	169
Alcor.....	177
T.....	185
Aqua.....	223
Miro'.....	233
936.....	249
Pat.....	259
Brasil & Hotellerie.....	269
Cucina / Kitchen.....	277

[www.bongio.it](http://www.bongio.it)

WELCOME...







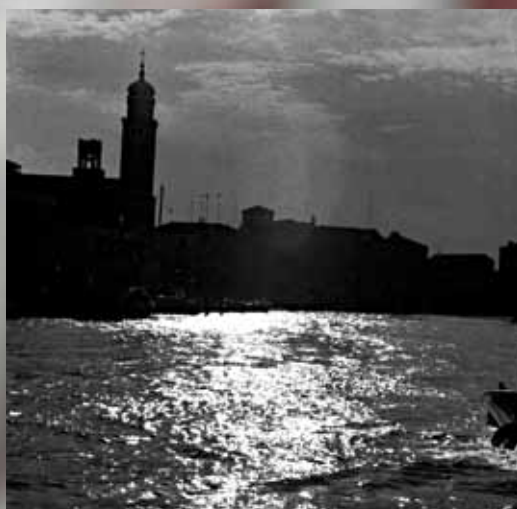

**Soffi**

design . Massimiliano Della Monaca  
engineering . Studio Tecnico Bongio

Dalla profonda sensibilità stilistica e dalla cultura di prodotto Bongio nasce la raffinata collezione SOFFI, una linea completa di rubinetteria fine che esalta lo spirito più nobile dell'autentico vetro di Murano certificato dal Consorzio Promovetro come "Vetro Artistico Murano".

*With its deep sense of style and product culture, Bongio introduces the elegant SOFFI collection, a complete line of taps and fittings that extols the noblest spirit of authentic Murano glass, certified by the Consorzio Promovetro as "Murano Artistic Glass."*

La calma e la saggezza del più alto artigianato, puro e intatto nel tempo, incorruttibile dalla violenza delle mode, un esempio e una testimonianza di perfezione che tutto il mondo ci invidia. Pezzi unici, irripetibili, parlanti, capaci di una dialettica raffinata e armoniosa con l'arredo di qualsiasi sala da bagno e di una cifra stilistica ben marcata e caratterizzante, per vestire lo spazio con il nostro più intimo sentire. Finalmente il design riesce a recuperare i contenuti più alti in termini di studio, di materia e di funzionalità lasciandosi alle spalle la più spicciola autocelebrazione spesso in contrasto con le abitudini contemporanee. Lucido o opaco, battuto o pettinato, declinato in suggestive vibrazioni cromatiche, il vetro di Murano della

collezione SOFFI rappresenta un inconfondibile accento di stile dall'alto contenuto artistico e progettuale. Sì, perché qui è riversata a piene mani tutta la conoscenza del designer Massimiliano Della Monaca nella progettazione di rubinetteria di alta gamma e nella passione per le antiche lavorazioni del vetro di Murano.

Un incontro che celebra un modo nuovo di pensare alla rubinetteria da bagno, trasversale nello stile e nella proposta, in grado di intercettare i palati più fini del pianeta. Non a caso Bongio, da più di 70 anni, rappresenta un vero e proprio avamposto di creatività e innovazione, un ambasciatore di quella autentica italianità che ci fa grandi nel mondo.



*The calm and wisdom of the finest handicrafts, pure and unimpaired over the years, incorruptible by changing fashion, an example of perfection envied the world over. Unique, eloquent pieces, capable of refined and harmonious dialogue with any bathroom, a distinctive stylistic code embellishing the space with our most intimate feelings. Finally, design recovers the loftiest contents in terms of research, materials, and function, leaving behind commonplace self-congratulation in conflict with modern customs. Polished or opaque, hammered or smooth, inflected with fascinating colours, the Murano glass in the Soffi collection is an*

*unmistakeable touch of style with high artistic and design content. Because designer Massimiliano Della Monaca has merged all of his expertise in designing luxury taps and fittings with his passion for traditional Murano glass production. A combination that celebrates a new way of looking at bathroom taps and fittings, transverse in style and content, able to delight the most refined tastes. It is no coincidence that Bongio has led the way in creativity and innovation for over 70 years: an ambassador of authentic Italian quality esteemed all over the world.*

# SOFFI

Design Massimiliano Della Monaca  
Engineering Studio Tecnico Bongio

## 60972

Bocca incasso vasca.  
*Built in bath spout.*

## 60978

Bocca incasso lavabo.  
*Built in basin spout.*

## 60524

Miscelatore incasso  
progressivo solo metallo.  
*Progressive built in mixer  
only brass.*

## 60556

Deviatore incasso solo metallo.  
*Built in diverter only brass.*

## 60514

Miscelatore incasso  
progressivo vetro+metallo.  
*Progressive built in mixer  
brass+glass.*

## 60525

Deviatore incasso vetro+metallo.  
*Built in diverter brass+glass.*

## 60502

Bocca bidet.  
*Bidet spout.*

60972 - 60978



60524 - 60556

60514 - 60525

60502



**SOFFI**







# SOFFI





# SOFFI





**SOFFI**





**60510**

Miscelatore bordo piano  
progressivo vetro+metallo.

*Progressive mixer for deck  
installation brass+glass.*

**60535**

Deviatore bordo vasca  
vetro+metallo.

*Bath diverter for deck  
installation brass+glass.*

**60520**

Miscelatore bordo piano  
progressivo solo metallo.

*Progressive mixer for deck  
installation only brass.*

**60566**

Deviatore bordo vasca  
solo metallo.

*Bath diverter for deck  
installation only brass.*

**60840**

Kit doccia bordo vasca  
minimalista.

*Handshower set for deck  
installation.*

**60830**

Kit duplex minimalista.

*Duplex handshower set.*

60510 - 60535

60520 - 60566



60840

60830





SOFFI





# SOFFI







**SOFFI**





**SOFFI**







# SOFFI

## 60546/D

Colonna doccia termostatica esterna coassiale Ø 42, soffione tondo Ø 200 e set duplex.

*Coaxial external shower column Ø 42 with thermostatic mixer, Ø 200 round shower and duplex shower set.*

## 60804/30

Braccio doccia a soffitto da 30 cms.

*30 cms. Ceiling shower arm.*

## 60804/40

Braccio doccia a soffitto da 40 cms.

*40 cms. Ceiling shower arm.*

## 60961

Soffione Ø 10.

*Ø 10 shower head.*

## 60960

Soffione tondo Ø 20.

*Ø 20 round shower head.*

DA INSTALLARSI SOLO ED  
ESCLUSIVAMENTE CON I  
NOSTRI BRACCI A SOFFITTO  
ART 60804.

*TO BE INSTALLED ONLY  
TOGETHER WITH OUR CEILING  
SHOWER ARM ART. 60804.*

60804/30 - 60804/40

60960



60546/D



60961

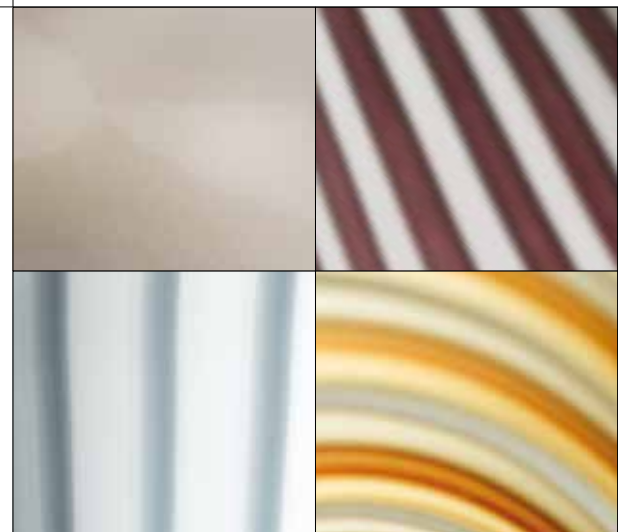

FINITURE / FINISHING



# SOFFI









# RIVA

design Marco Poletti

engineering Antonio Bongio . Fabio Frattini





**57521/22**

Miscelatore monocomando  
lavabo senza scarico.

*Basin mixer without waste.*

**57539**

Miscelatore monocomando  
lavabo incasso.

*Built-in basin mixer.*



57521/22



57539

**RIVA**



**57526/D**

Miscelatore monocomando  
vasca con set doccia duplex.

*Bath and shower mixer  
with duplex shower set.*



57526/D



57539

## 57883

Soffione con braccio doccia e regolatore di portata.  
*Shower head with arm and regulation of the flow.*

## 57529

Miscelatore monocomando doccia incasso con deviatore.  
*Built-in shower mixer with diverter.*

## 57524

Miscelatore monocomando doccia incasso.  
*Built-in shower mixer.*

57883



57524

**57131**

Colonna doccia termostatica  
con deviatore e set doccia.

*Thermostatic shower column  
with diverter and shower set.*



57529

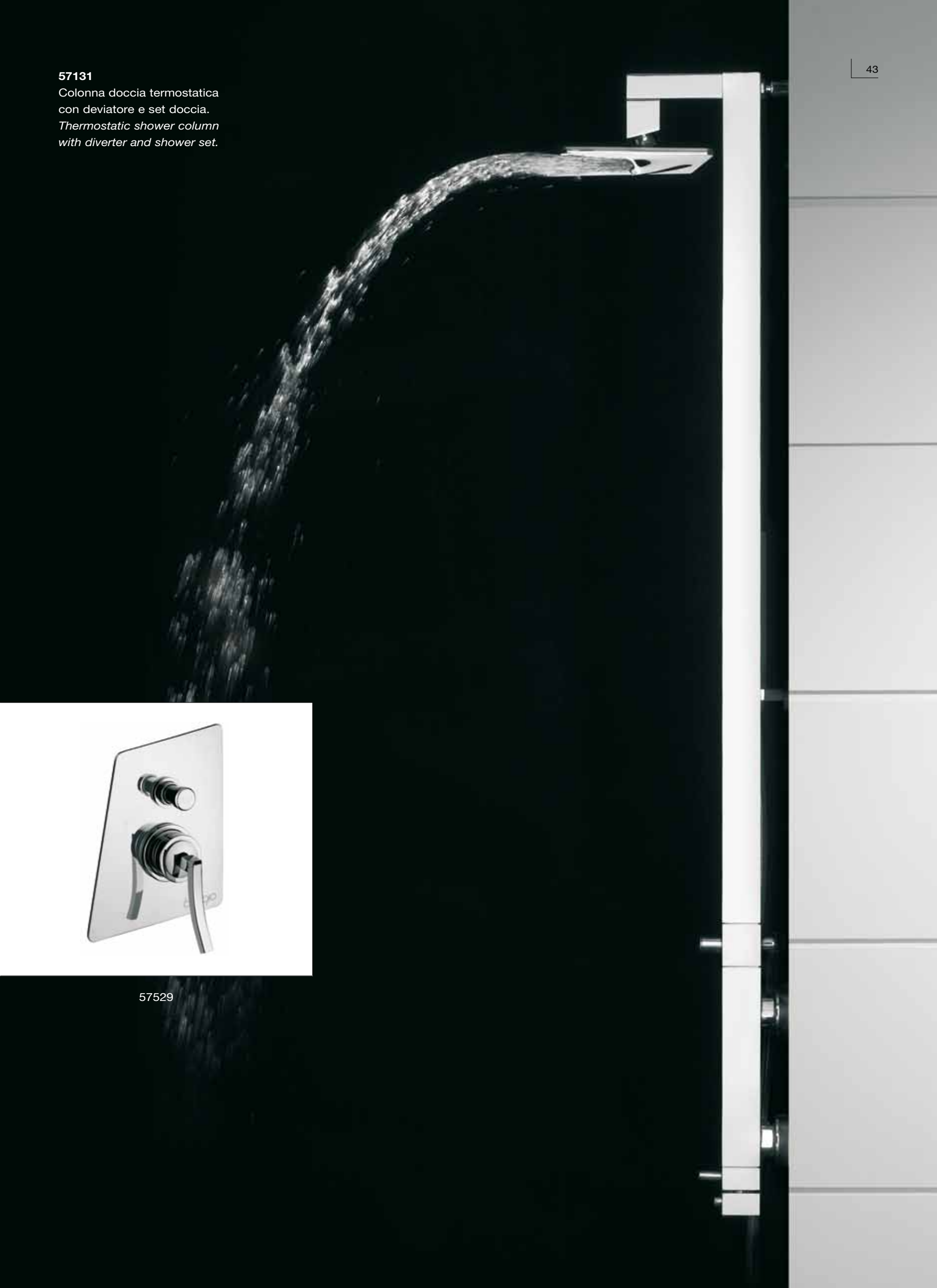

# RIVA HT



**58883**

Soffione con braccio doccia  
e regolatore di portata.  
*Shower head with arm  
and regulation of the flow.*



# RIVA HT



58526/D





**58526/D**

Miscelatore monocomando vasca con set doccia duplex.  
*Bath and shower mixer with duplex shower set.*

**58131**

Colonna doccia termostatica con deviatore e set doccia.  
*Thermostatic shower column with diverter and shower set.*

**58521/22**

Miscelatore monocomando lavabo/bidet senza scarico.  
*Basin/bidet mixer without waste.*

**58539**

Miscelatore monocomando lavabo incasso.  
*Built-in basin mixer.*

**58883**

Soffione con braccio doccia e regolatore di portata.  
*Shower head with arm and regulation of the flow.*

**58524**

Miscelatore monocomando doccia incasso.  
*Built-in shower mixer.*

**58529**

Miscelatore monocomando doccia incasso con deviatore.  
*Built-in shower mixer with diverter.*

58521/22



58539



58883



58524



58529





# ACQUAVIVA

design Antonio Bongio . Marco Poletti . Vegni Design  
concept Roberto Niccolai  
engineering Antonio Bongio . Fabio Frattini



**56991/12**

Bocca incasso da cm. 12 su piastra.  
*12 cms. built-in spout on plate.*

**56991/18**

Bocca incasso da cm. 18 su piastra.  
*18 cms. built-in spout on plate.*

**56991/22**

Bocca incasso da cm. 22 su piastra.  
*22 cms. built-in spout on plate.*



56991/12



56991/18



56991/22

# ACQUAVIVA

56539/12



56539/18

**56539/12**

Gruppo lavabo a parete con bocca cm. 12 e miscelatore su piastra unica, con scatola incasso, collegamenti interni, dispositivo di regolazione portata, contro piastra in acciaio inox per fissaggio.  
*Wall basin mixer with 12 cms. spout and mixer on single plate, with built-in box, internal connections, flow regulation system, back fixing plate in stainless steel.*

**56539/18**

Gruppo lavabo a parete con bocca cm.18 e miscelatore su piastra unica, con scatola incasso, collegamenti interni, dispositivo di regolazione portata, contro piastra in acciaio inox per fissaggio.  
*Wall basin mixer with 18 cms. spout and mixer on single plate, with built-in box, internal connections, flow regulation system, back fixing plate in stainless steel.*

**56539/22**

Gruppo lavabo a parete con bocca cm.22 e miscelatore su piastra unica, con scatola incasso, collegamenti interni, dispositivo di regolazione portata, contro piastra in acciaio inox per fissaggio.  
*Wall basin mixer with 22 cms. spout and mixer on single plate, with built-in box, internal connections, flow regulation system, back fixing plate in stainless steel.*



56539/22



# ACQUAVIVA

56538/12



## 56538/12

Gruppo lavabo a parete composto da bocca incasso cm.12 e miscelatore su piastre separate con scatole incasso, collegamenti interni, dispositivo

di regolazione portata acqua, contro piastre in acciaio inox per fissaggio.

*Wall basin mixer with 12 cms. Spout and mixer on separate plates with built-in boxes, internal connections, flow regulations system, back fixing plates in stainless stess.*

## 56538/18

Gruppo lavabo a parete composto da bocca incasso cm.18 e miscelatore su piastre separate con scatole incasso, collegamenti interni, dispositivo di regolazione portata acqua, contro piastre in acciaio inox per fissaggio.

*Wall basin mixer with 18 cms. Spout and mixer on separate plates with built-in boxes, internal connections, flow regulations system, back fixing plates in stainless stess.*

## 56538/22

Gruppo lavabo a parete composto da bocca incasso cm. 22 e miscelatore su piastre separate con scatole incasso, collegamenti interni, dispositivo di regolazione portata acqua, contro piastre in acciaio inox per fissaggio.

*Wall basin mixer with 22 cms. Spout and mixer on separate plates with built-in boxes, internal connections, flow regulations system, back fixing plates in stainless stess.*



56538/18



56538/22





# ACQUAVIVA

56521



56522

**56521**

Monocomando lavabo  
senza scarico.  
*Single lever basin  
mixer without waste.*

**56522**

Monocomando bidet  
senza scarico.  
*Single lever bidet  
mixer without waste.*

**56532**

Monocomando lavabo  
con prolunga senza scarico.  
*Single lever basin mixer  
with extension and without waste.*



56532



# ACQUAVIVA

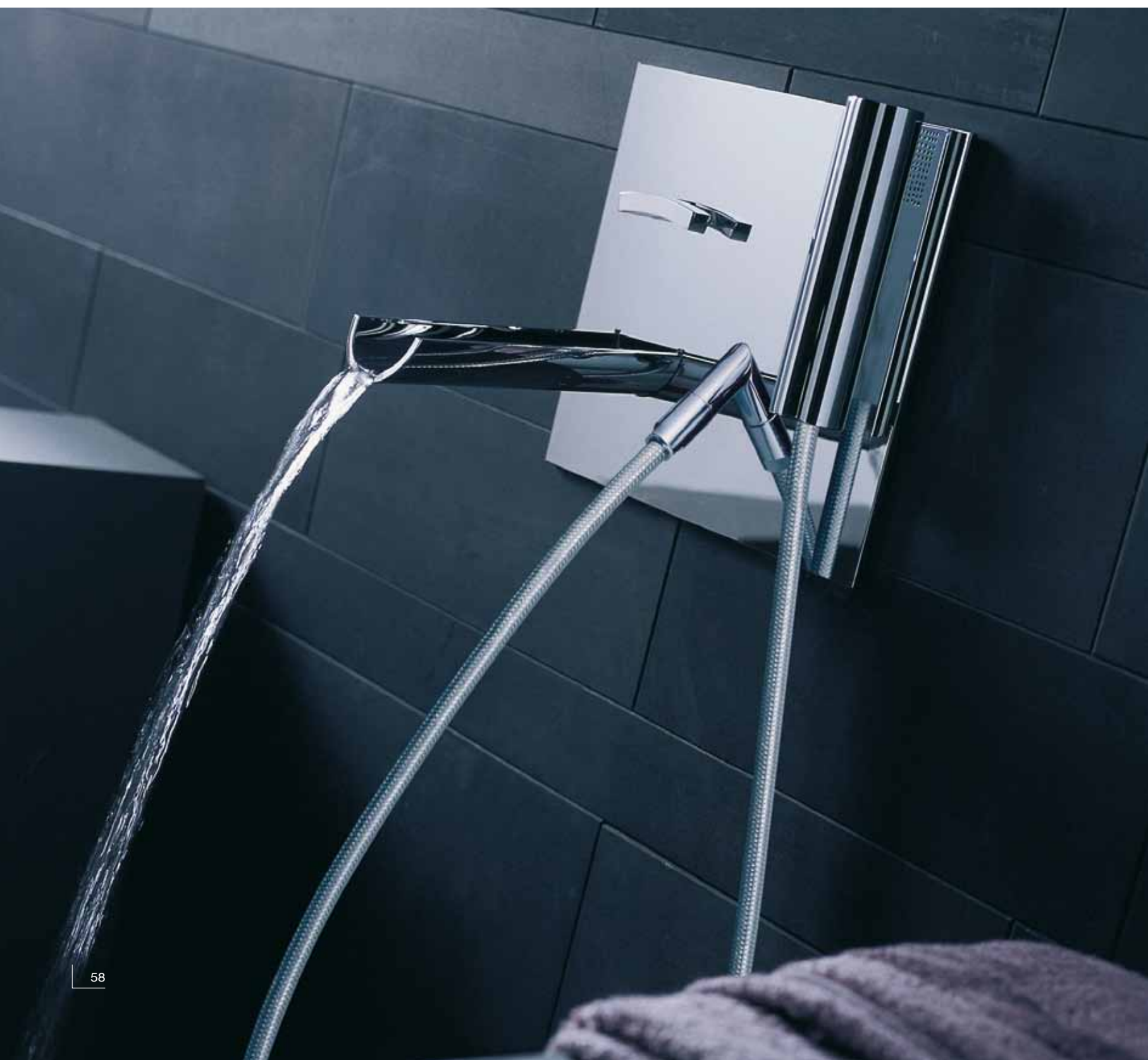

**56530/18**

Gruppo vasca a parete con bocca cm. 18, miscelatore, set doccia, deviatore, scatola incasso, collegamenti interni, contro piastra per fissaggio in acciaio inox.

*Built-in bath and shower mixer with 18 cms. spout, mixer, shower set, diverter, built-in box, internal connections, back fixing plate in stainless steel.*

**56530/22**

Gruppo vasca a parete con bocca cm. 22, miscelatore, set doccia, deviatore, scatola incasso, collegamenti interni, contro piastra per fissaggio in acciaio inox.

*Built-in bath and shower mixer with 22 cms. spout, mixer, shower set, diverter, built-in box, internal connections, back fixing plate in stainless steel.*

56530/18



56530/22

# ACQUAVIVA





# ACQUAVIVA

## 56531/D

Gruppo vasca con bocca incasso cm. 22 con scatola incasso, collegamenti interni, dispositivo di regolazione portata acqua, contro piastra in acciaio inox per fissaggio più set bordo vasca con miscelatore, set doccia e deviatore su piastra.

*Bath and shower mixer with 22 cms. built-in spout, built-in box, internal connections, flow regulation system, back fixing plate in stainless steel and deck bath set with mixer, shower set and diverter on plate.*

56531/D



## 56524

Miscelatore incasso doccia con scatola incasso, contro piastra in acciaio inox per fissaggio.

*Built-in single lever shower mixer with built-in box, back fixing plate in stainless steel.*



56524

## 56835

Deviatore incasso con set doccia.

*Built-in diverter with handshower set.*



56835





**ACQUAVIVA**



**56529/P**

Set bordo vasca con miscelatore,  
set doccia e deviatore su piastra.  
*Deck bath set with mixer,  
shower set and diverter on plate.*

**56528**

Colonna vasca da pavimento con  
miscelatore, set doccia, deviatore.  
*Bath column to the floor with  
mixer, shower set, diverter.*



56528

# ACQUAVIVA



## **56131**

Colonna doccia cm. 155 con  
miscelatore, set doccia, deviatore  
e dispositivo di regolazione portata.  
*155 cms. shower column with mixer,  
shower set, diverter and  
flow regulation system.*





# ACQUAVIVA



# ACQUAVIVA BRILLANT

Made with Swarovski® Elements

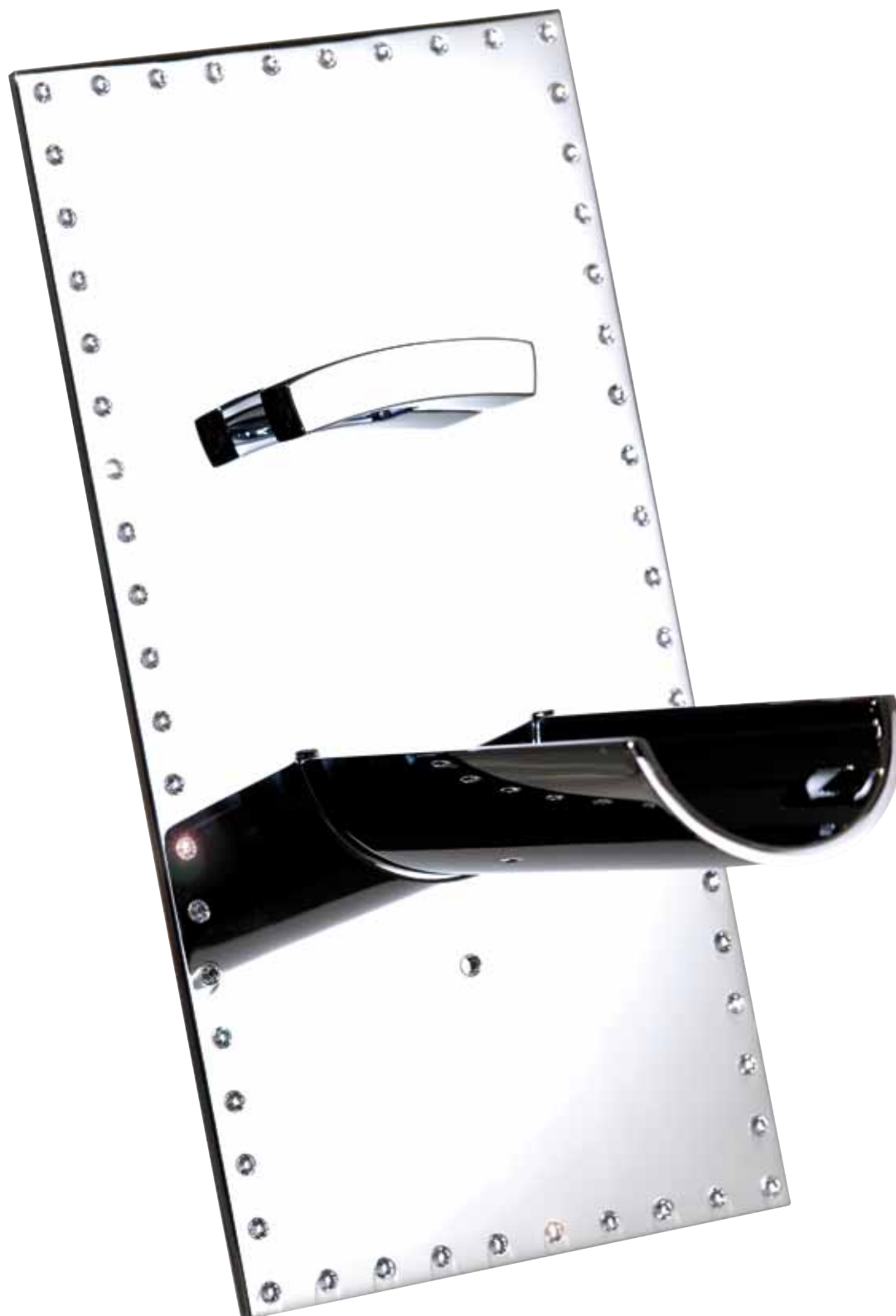

## **55539/12/18/22**

Gruppo lavabo a parete con bocca mm. 120/180/220 e miscelatore su piastra unica, con scatola incasso, collegamenti interni, dispositivo di regolazione portata, cartuccia progressiva.

*Wall basin mixer with 120/180/220 mms. spout and mixer on single plate, with built-in box, internal connections, flow regulation system, progressive cartridge.*

# ACQUAVIVA CONTINUA



56539

## **SI00200LU**

Sistema luce bianca da applicare agli articoli 56539 (56539+SI00200LU)  
White light system for items 56539 (56539+SI00200LU)

## **SI00100EL**

Sistema infrarossi da applicare agli articoli 56992 (56992+SI00100EL)  
Infra-red system for items 56992 (56992+SI00100EL)

## **56521EL**

Monocomando lavabo con sistema infrarossi applicato senza scarico.  
*Single lever basin mixer with infra-red system and without waste.*



56992





**SI00300PA**

Incisione "parole" su articoli 56539  
(56539+SI00300PA).

Engraving of "parole" on the items  
(56539+SI00300PA)

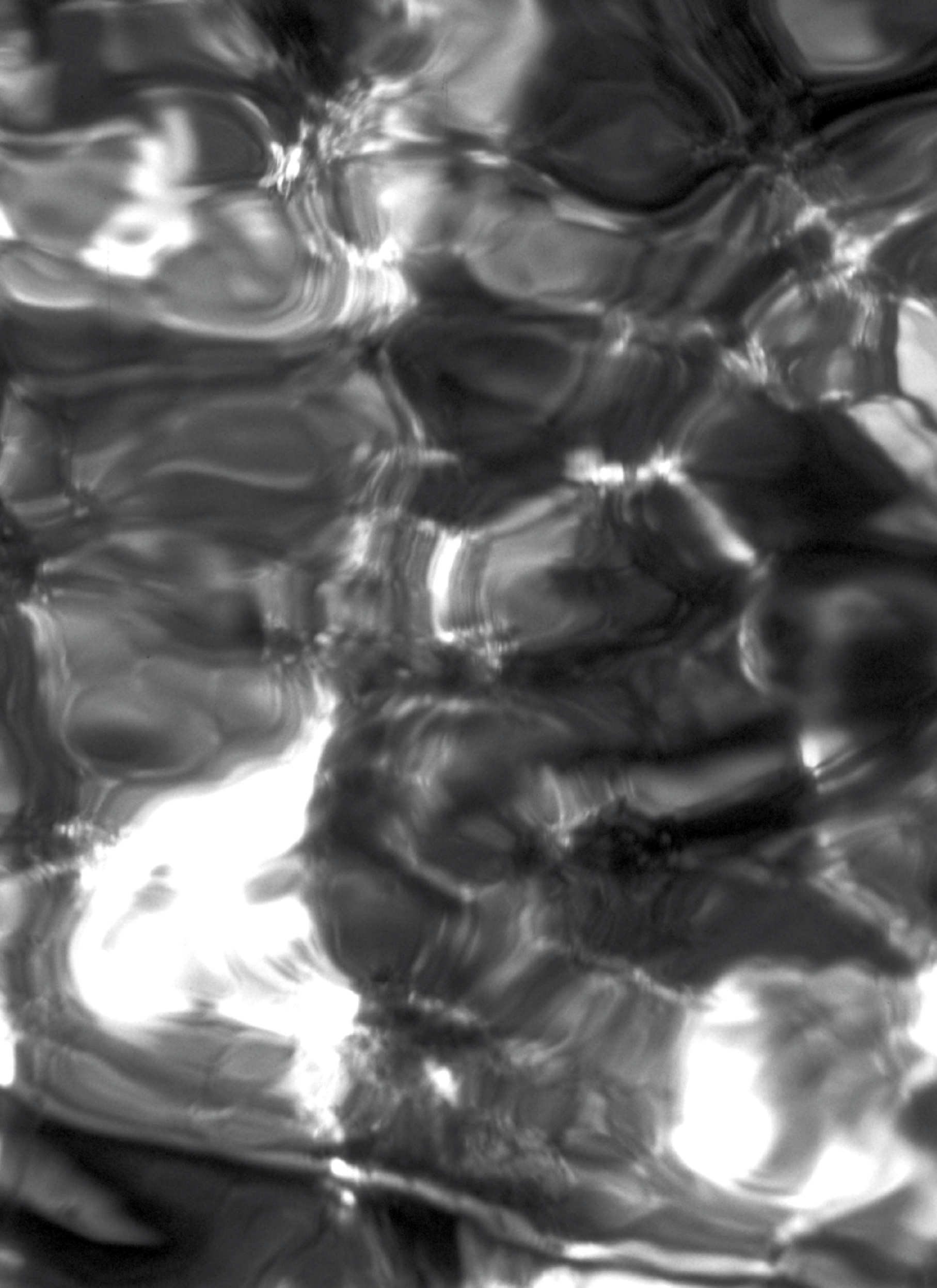



# O'CLOCK

design Marco Poletti  
engineering Studio Tecnico Bongio

**14521**  
Monocomando lavabo.  
*Basin mixer.*

**14522**  
Monocomando bidet.  
*Bidet mixer.*

**14532**  
Monocomando lavabo  
completo di prolunga.  
*Basin mixer with extension.*

**14533**  
Monocomando lavabo da  
pavimento.  
*Floor basin mixer column.*

14521



14532



14522

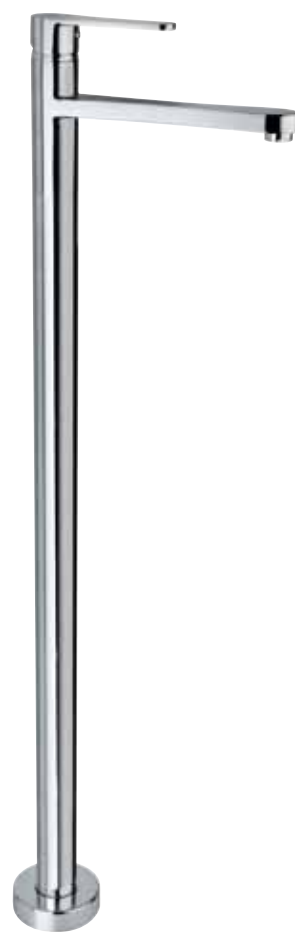

14533



# O'CLOCK



**977/M**

Bocca da soffitto  
con miscelatore incorporato.  
*Spout from ceiling  
with mixer included in the spout.*

**14538/16/22**

Miscelatore monocomando lavabo  
incasso con bocca da 16/22 cm.  
*Built-in basin mixer  
with 16/22 cms. spout.*

**14438/16/22**

Miscelatore monocomando lavabo  
incasso con bocca da 16/22 cm.  
*Built-in basin mixer  
with 16/22 cms. spout.*



977/M



14538/16/22



14438/16/22

# O'CLOCK

**14534/D**

Miscelatore vasca a pavimento  
con set doccia e deviatore.

*Bath mixer to the floor  
with shower set and diverter.*



14534/D





# O'CLOCK

**14889**

Soffione doccia  
tondo a muro.  
*Built-in round  
shower head.*

**14529**

Miscelatore monocomando  
doccia incasso con deviatore.  
*Built-in shower mixer  
with diverter.*

**14524**

Miscelatore monocomando  
doccia incasso.  
*Built-in shower mixer.*

**14530/D**

Miscelatore monocomando  
vasca incasso completo.  
*Built-in bath & shower mixer.*

14889



14524



14529



14530/D



# O'CLOCK



**14526/D**

Miscelatore monocomando  
vasca con set doccia duplex.  
*Bath and shower mixer  
with duplex shower set.*

**14531/D**

Miscelatore monocomando  
bordo vasca completo.  
*Bath and shower mixer  
for deck installation.*

**997/16/22**

Bocca incasso 16/22 cm.  
*16/22 cms. built-in spout.*

**986/16/22**

Bocca incasso Ø mm. 24,  
cm. 16/22 lunghezza, 1/2M.  
*Built-in spout, 24 mms. Ø,  
1/2M, 16/22 cms. long.*

997/16/22



14526/D



14531/D



986/16/22

# O'CLOCK





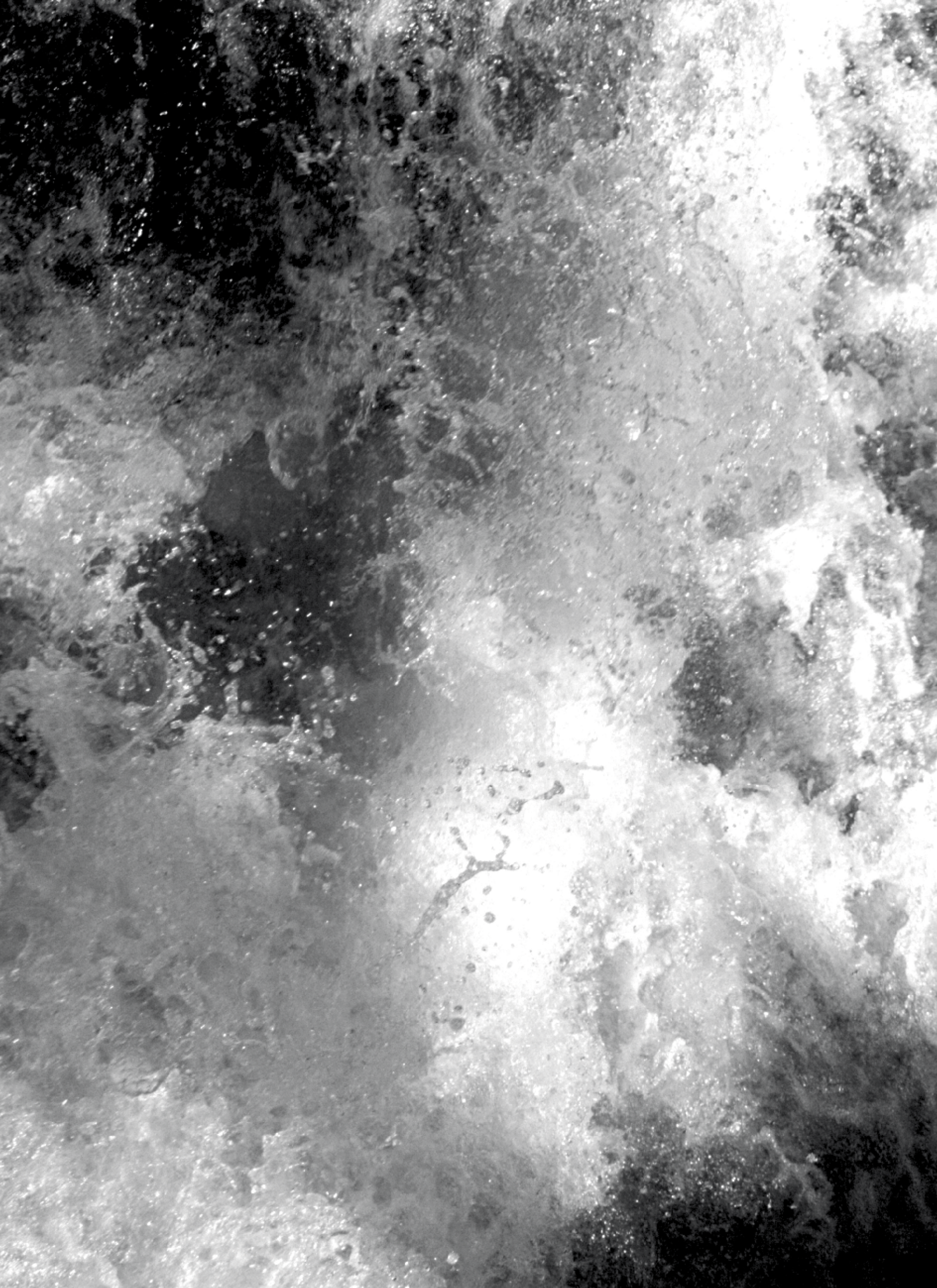





# ELETTRONICI

engineering Studio Tecnico Bongio

## 46521/EL

Bocca erogazione con sistema elettronico.  
*Erogation spout with electronical system.*

## 46533/EL

Bocca erogazione a pavimento con sistema elettronico.  
*Erogation spout to the floor with electronical system.*

## 46532/EL

Bocca erogazione con sistema elettronico e prolunga da 150 mm.  
*Erogation spout with electronical system and 150 mms. extension.*



46521/EL



46532/EL

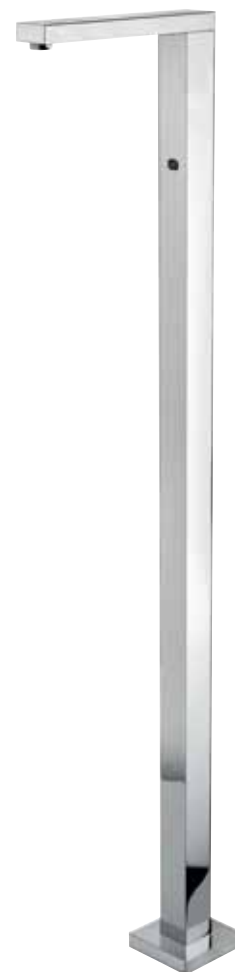

46533/EL

**56521/EL**

Miscelatore lavabo elettronico senza scarico con regolatore di portata.

*Basin mixer with battery infrared system, without waste with flow regulation system.*

**56992/EL 12-18-22**

Gruppo lavabo a parete con bocca 120/180/220 mm., regolatore di temperatura, regolatore di portata, scatola incasso, da vendere unitamente al sistema ad infrarossi cod. SI00100EL.

*Wall basin mixer with 120/180/220 mms. spout, temperature regulation system, flow regulation system and built-in box to be sold together with the infrared system ref. SI00100EL.*



56521/EL



56992/EL 12-18-22

# ELETRONICI

## 30501/EL

Bocca erogazione con sistema elettronico.  
*Erogation spout with electronical system.*

## 977/EL

Bocca elettronica a soffitto.  
*Ceiling spout with electronical system.*

## 46992/EL

Bocca incasso elettronica mm. 220.  
*220 mms. built-in spout with electronical system.*



30501/EL



46992/EL



977/EL







# STELTH

Design Marco Poletti

## 01521

Miscelatore lavabo senza scarico.  
*Basin mixer without waste.*

## 01532

Miscelatore lavabo con  
prolunga cm. 15 senza scarico.  
*Basin mixer with 15 cms.  
extension without waste.*

## 01522

Miscelatore bidet senza scarico.  
*Bidet mixer without waste.*

## 01533

Miscelatore lavabo da terra.  
*Basin mixer to the floor.*

01521



01532



01522

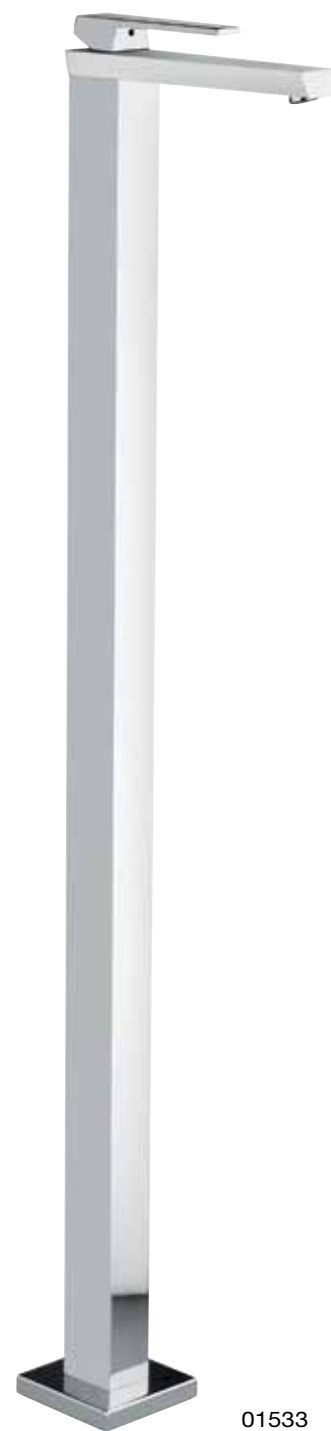

01533





# STELTH



**01538/16/22**

Miscelatore lavabo incasso  
a parete con bocca cm. 16/22.  
*Wall basin mixer with  
16/22 cms. spout.*

**03538/16/22**

Gruppo lavabo incasso  
3 fori con bocca cm. 16/22.  
*3-holes built-in basin mixer  
with 16/22 cms. spout.*

**03501**

Gruppo lavabo 3 fori  
senza scarico.  
*3-holes basin mixer  
without waste.*

**03500**

Rubinetto a incasso 1/2".  
*1/2" built-in tap.*

**01524**

Miscelatore incasso doccia.  
*Built-in shower mixer.*

**01529**

Miscelatore incasso  
doccia con deviatore.  
*Built-in shower mixer  
with diverter.*

01538/16/22

03538/16/22

03501



03500

01524

01529

STELTH





# STELTH



**01530/D**  
Miscelatore vasca incasso  
con deviatore e set doccia.  
*Built-in bath with diverter  
and duplex shower set.*

**01534**  
Miscelatore vasca da terra  
con set doccia.  
*Bath mixer to the floor  
with handshower set.*

**01531/D**  
Miscelatore bordo  
vasca con set doccia.  
*Deck bath mixer with  
handshower set.*

**03531/D**  
Gruppo bordo vasca 5 fori.  
*5-holes deck bath  
and shower set.*

01531/D



01534

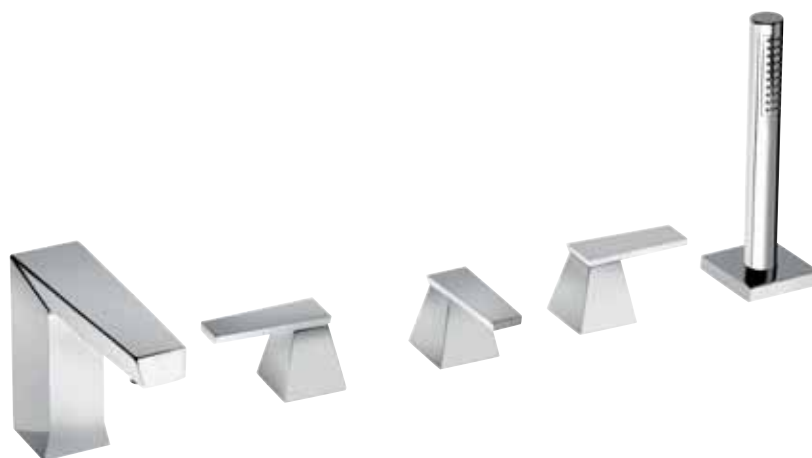

03531/D



01526/D

**01526/D**

Miscelatore monocomando vasca con set doccia duplex.  
*Bath & shower mixer with duplex shower set.*



01881 + 806

**01881**

Soffione doccia.  
*Shower head.*

**806**

Braccio doccia.  
*Shower arm.*

# STELTH COORDINATI

01001



01007/40/60



30027



30028



30025



30022

**01001**

Porta abito.  
*Robe hook.*

**01007/40/60**

Porta asciugamano 40/60 cm.  
*40/60 cms. towel rail.*

**01009**

Porta carta.  
*Paper holder.*

**30022**

Bicchiere appoggio.  
*Glass holder to lean.*

**30027**

Dispenser appoggio.  
*Dispenser to lean.*

**30028**

Porta sapone appoggio.  
*Soap holder to lean.*

**30025**

Scopino appoggio.  
*Toilet brush to lean.*

**30017**

Cestello rettangolare.  
*Rectangular shower basket.*



30017





# CRYSTAL

INSERTI IN VETRO DI MURANO / INSERTS MADE IN MURANO GLASS

design Marco Poletti & Massimiliano Della Monaca  
engineering Studio Tecnico Bongio





**48900CRAG**  
Argento  
*Silver*



**48900CRBI**  
Bianco/Nero  
*Mat White/Black*



**48900CRMA**  
Marrone/Nero  
*Brown/Black*



**48900CROR**  
Oro  
*Golden*



**48900CRLI**  
Lilla  
*Lilac*



**48900CRVE**  
Verde/Bordeaux  
*Green/Bordeaux*



**48900ORAM**  
Ambra  
*Amber*



**48900OROR**  
Oro  
*Golden*



**48900ORRS**  
Rosso foglia oro  
*Red/Golden*



**49900CR00**  
Cromo  
*Chrome*



48521



48522

**48521**

Miscelatore lavabo con piletta clic-clac.  
*Basin mixer with clic-clac waste.*

**48522**

Miscelatore bidet con piletta clic-clac.  
*Bidet mixer with clic-clac waste.*

# CRYSTAL



48532



**48532**

Miscelatore lavabo con prolunga mm. 150 e piletta clic-clac.  
*Basin mixer with 150 mms. extension and clic-clac waste.*

**48502**

Miscelatore lavabo 2 fori con piletta clic-clac.  
*Basin mixer 2 holes with clic-clac waste.*

**48501**

Tre fori lavabo con piletta clic-clac.  
*Three holes basin mixer with clic-clac waste.*

**48524**

Miscelatore incasso doccia.  
*Built-in shower mixer.*

**48529**

Miscelatore incasso doccia con deviatore.  
*Built-in shower mixer with diverter.*

**48537/D**

Miscelatore doccia esterno con tubo, soffione e set doccia duplex.  
*External shower mixer with tube, shower head and duplex shower set.*

48502



48501



48524



48529



# CRYSTAL





**48526/D**

Miscelatore vasca esterno  
con set doccia duplex.  
*External bath & shower mixer  
with duplex shower set.*

**48538/16/22**

Monocomando lavabo incasso  
con bocca da cm. 16/22.  
*Built-in basin mixer with  
16/22 cms. spout.*

48526/D



48538/16/22





# MYAMYX

design Marco Poletti  
engineering Studio Tecnico Bongio



46521



46522

**46521**

Monocomando lavabo  
con piletta clic-clac.  
*Basin mixer with clic-clac waste.*

**46522**

Monocomando bidet  
con piletta clic-clac.  
*Bidet mixer with clic-clac waste.*

**46532**

Monocomando lavabo con  
prolunga e piletta clic-clac.  
*Basin mixer with extension  
and clic-clac waste.*

**46501**

Miscelatore lavabo 2 fori  
con piletta clic-clac.  
*Basin mixer 2 holes with  
clic-clac waste.*



46532



46501

**46521/EL**

Bocca erogazione con  
sistema elettronico.  
*Erogation spout with  
electronical system.*

**MYAMYX BRILLANT**

Made with Swarovski® Elements

**59521**

Monocomando lavabo  
con piletta clic-clac.  
*Basin mixer with clic-clac waste.*

**45521**

Monoforo lavabo con piletta clic-clac e bocca girevole.

*Basin monobloc with swivel spout and clic-clac waste.*

**45522**

Monoforo bidet con piletta clic-clac e bocca girevole.

*Bidet monobloc with swivel spout and clic-clac waste.*

**45501**

Tre fori lavabo con piletta clic-clac.

*Three holes basin mixer with clic-clac waste.*

45521



45522



45501



**MYAMYX**

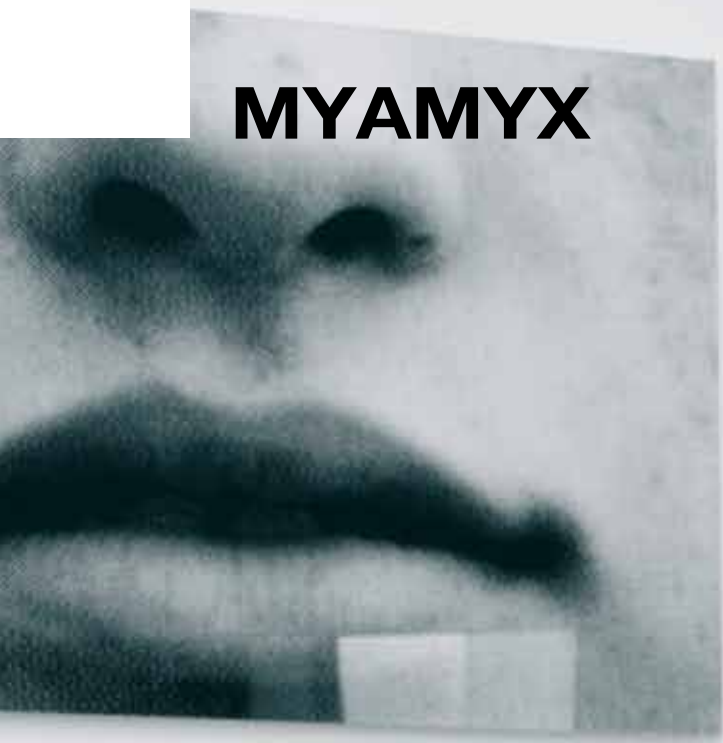



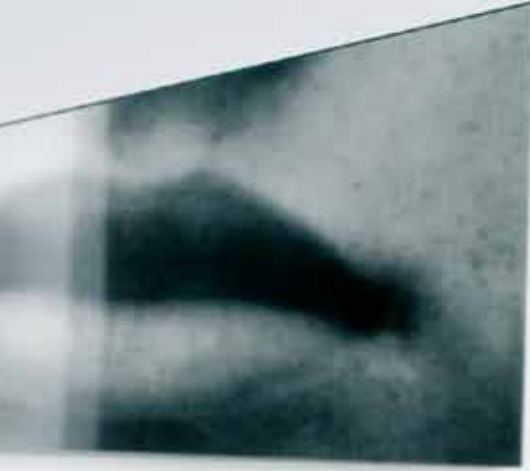

**46539/16/22**

Monocomando lavabo incasso con piastra e bocca da cm. 16/22.  
*Built/in basin mixer with plate and 16/22 cms. spout.*

**46538/16/22**

Monocomando lavabo incasso con bocca da cm. 16/22.  
*Built/in basin mixer with 16/22 cms. spout.*

**45538/16/22**

Gruppo lavabo incasso 3 fori con bocca da cm. 16/22.  
*3-holes built in basin mixer with 16/22 cms. spout.*

46539/16/22



46538/16/22



**46526/D**

Monocomando vasca esterno con set doccia duplex.  
*External bath and shower mixer with duplex shower set.*

**992/16/22**

Bocca vasca incasso piatta cm. 16/22.  
*16/22 cms. flat built-in spout.*

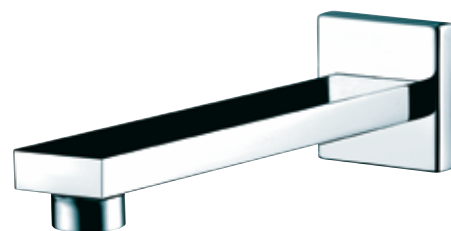
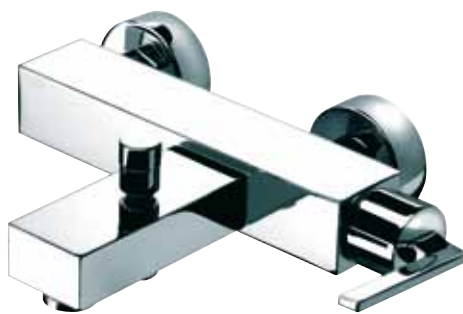

45538/16/22

46526/D

992/16/22



**46524**

Monocomando incasso doccia.  
*Built-in shower mixer.*

**46529**

Monocomando incasso doccia  
con deviatore.  
*Built-in shower mixer with diverter.*

**46531/D**

Monocomando bordo vasca  
con kit doccia.  
*Bath and shower mixer for deck  
installation.*

**46530/D**

Gruppo vasca incasso con set  
doccia duplex.  
*Built-in bath and shower mixer  
with duplex shower set.*



46529



46531/D





**MYAMYX**



46533

**46533**

Monocomando lavabo da pavimento.  
*Floor basin mixer column.*

**46534CR0D**

Miscelatore vasca a pavimento  
con set doccia e deviatore.  
*Bath mixer to the floor  
with shower set and diverter.*



46534CR0D

993/85/105

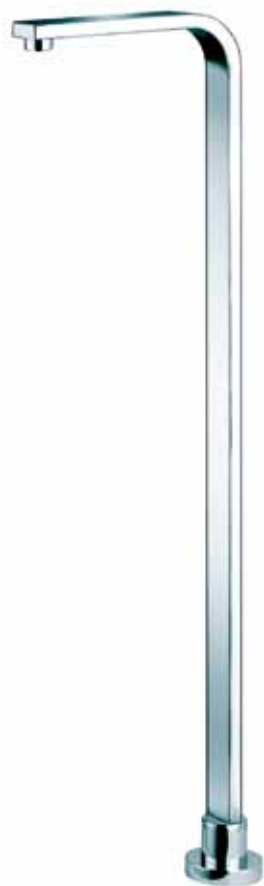

**993/85/105**

Bocca piatta a pavimento cm. 85-105.  
*85-105 cms. flat spout to the floor.*

**46131**

Colonna doccia completa  
di miscelatore.  
*Shower column with mixer.*

**46537/D**

Monocomando doccia esterno con  
tubo, soffione e set doccia duplex.  
*External shower mixer with tube, shower  
head and duplex shower set.*

46537/D









# DOMINO

Bongio design

## 43521

Monocomando lavabo con scarico clic-clac.

*Basin mixer with clic-clac waste.*

## 43532

Monocomando lavabo completo di prolunga cm. 15 scarico clic-clac.

*Basin mixer with 15 cms. extension and clic-clac waste.*

## 43539/16/22

Monocomando lavabo a parete con piastra e bocca da cm. 16/22 completa di scatola incasso acciaio.

*Wall basin mixer with 16/22 cms. spout, plate and built-in stainless steel box.*

## 43522

Monocomando bidet completo di scarico clic-clac.

*Bidet mixer with clic-clac waste.*

43521



43532



43539/16/22



43522



# DOMINO

## 43526/D

Monocomando vasca esterno con set doccia.  
*External bath mixer with shower set.*

## 43525/3

Deviatore 3 vie.  
*3 ways diverter.*

## 43524

Monocomando incasso doccia.  
*Built-in shower mixer.*

## 43544

Termostatico coassiale incasso doccia.  
*Coaxial thermostatic built-in shower mixer.*

## 43529

Monocomando incasso doccia con deviatore.  
*Built-in shower mixer with diverter.*

## 43549

Termostatico coassiale incasso doccia con deviatore.  
*Coaxial thermostatic built-in shower mixer with diverter.*

43526/D



43524



43529



43525/3

43544

43549



# DOMINO





**43529/P**

Monocomando bordo vasca senza bocca.  
*Deck bath and shower mixer without spout.*

**43534/D**

Gruppo bordo vasca quattro fori con cartuccia progressiva.  
*Four holes deck bath and shower mixer with progressive cartridge.*

**43531/D**

Monocomando bordo vasca con bocca.  
*Deck bath and shower mixer with spout.*

**991/22**

Bocca incasso cm. 22.  
*22 cms. built-in square spout.*

**991/16**

Bocca incasso cm. 16.  
*16 cms. built-in square spout.*

**43537/D**

Monocomando doccia esterno completo di tubo doccia, soffione, deviatore e set doccia.  
*External shower mixer complete of shower tube, shower head, diverter and handshower set.*

43529/P



43531/D



43534/D



991/22 - 991/16



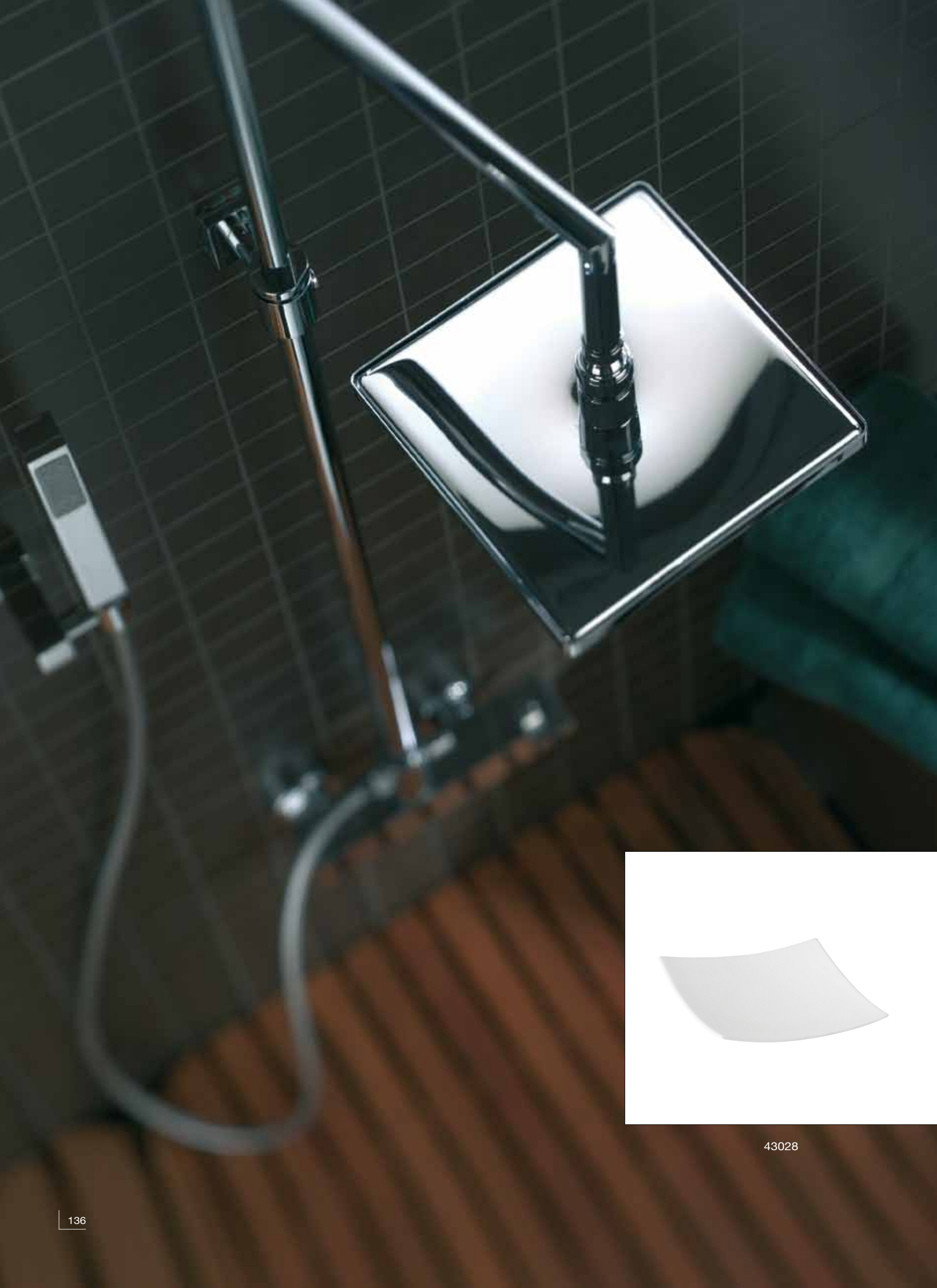

43028

# DOMINO COORDINATI

**43001**  
Porta abito.  
*Robe hook.*

**43009**  
Porta rotolo.  
*Toilet paper holder.*

**43007/40/60**  
Porta asciugamano mm 400/600.  
*400/600 mm towel rail.*

**43028**  
Porta sapone appoggio  
in ceramica.  
*Ceramic soap holder  
to lean.*

**43027**  
Dispenser appoggio  
in ceramica/ottone.  
*Ceramic/brass soap  
dispenser to lean.*

**43022**  
Bicchieri da appoggio  
in ceramica.  
*Ceramic glass to lean.*

**43025**  
Porta scopino appoggio  
in ceramica/ottone.  
*Ceramic/brass toilet  
holder to lean.*

43001



43009



43007/40/60



43027

43025





# GRIP

Bongio design

## 47521/L

Miscelatore monocomando  
lavabo senza scarico.

*Basin mixer without waste.*

## 47522/L

Miscelatore monocomando  
bidet senza scarico.

*Bidet mixer without waste.*

## 47532/L

Miscelatore monocomando  
lavabo prolungato senza scarico.

*Basin mixer with 15 cms. extension  
and without waste.*

## 47539

Miscelatore monocomando lavabo  
incasso da 22 cm. senza scarico.

*22 cms. built-in basin mixer  
without waste.*

47521/L



47522/L

47532/L

47539



# GRIP







# GRIP

## 47526/D

Miscelatore monocomando vasca esterno completo di set duplex.  
*External bath & shower mixer with duplex shower set.*

## 47524

Miscelatore monocomando doccia incasso.  
*Built-in shower mixer.*

## 47523

Miscelatore monocomando doccia esterno.  
*External shower mixer.*

47526/D



47523



47524



47529



47527

**47529**

Miscelatore monocomando  
doccia incasso con deviatore.

*Built-in shower  
mixer with diverter.*

**47527**

Miscelatore monocomando  
vasca esterno su colonnette  
bordo vasca.

*Built-in basin mixer  
without waste.*



# GRIP



**47131**  
Colonna doccia  
incasso con rubinetteria  
termostatica, deviatore,  
soffioncini basculanti  
e kit doccia.  
*Built-in shower  
column with  
thermostatic mixer,  
diverter, movable sprays  
and handshower set.*

## FACILE INSTALLAZIONE

Un facile e veloce montaggio.

1 - Installare la scatola nel muro e piastrellare.

2 - Collegare le 2 connessioni acqua al pannello doccia ed accostarlo alla scatola incassata. Il pannello si fisserà automaticamente grazie ad un sistema a magneti.

## EASY INSTALLATION

Easy and fast installation.

1 - insert the box into the wall and put the tiles.

2 - Connect the wall connections to the shower panel and draw up it to the box. They will attach together automatically through a magnetic system.

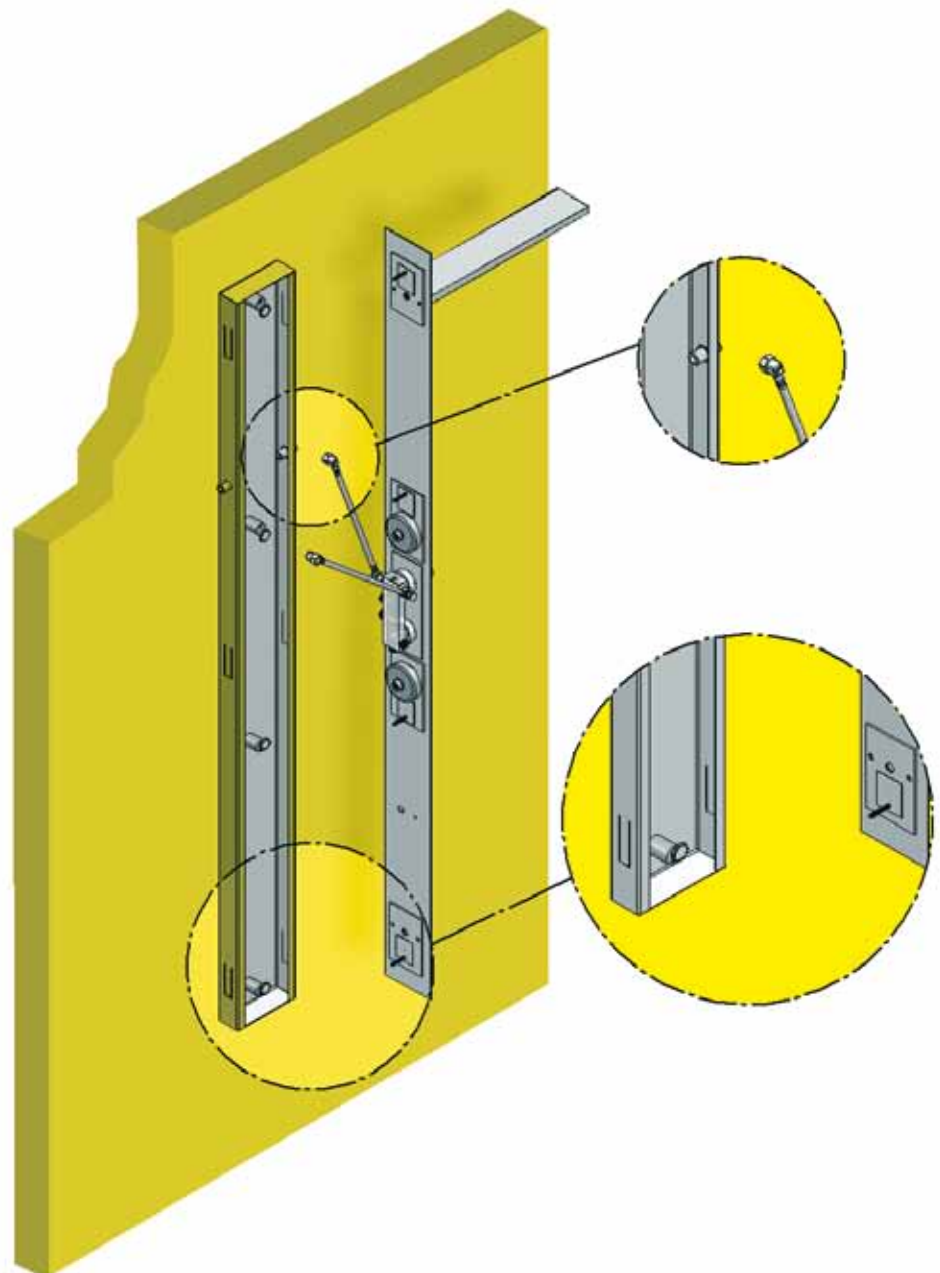

# GRIP

## 47131 / ES

Colonna doccia esterna con rubinetteria termostatica, deviatore, soffioncini basculanti e kit doccia.

*External shower column with thermostatic mixer, diverter, movable sprayers and handshower set.*

## 805+881

Braccio doccia + soffione doccia quadro.

*Shower arm + square shower head.*

## 805+880

Braccio doccia + soffione doccia tondo.

*Shower arm + round shower head.*

805 + 881



41531 / ES



805 + 880









# ONE

Marco Poletti design



**ONE**



**29521**

Monocomando lavabo completo di scarico clic-clac.  
*Basin mixer with clic-clac waste.*

**29532**

Monocomando lavabo completo di prolunga e di scarico clic-clac.  
*Basin mixer with extension and clic-clac waste.*

**29522**

Monocomando bidet completo di scarico clic-clac.  
*Bidet mixer with clic-clac waste.*

**847**

Soffione doccia.  
*Built-in shower head.*

29521



29532



29522

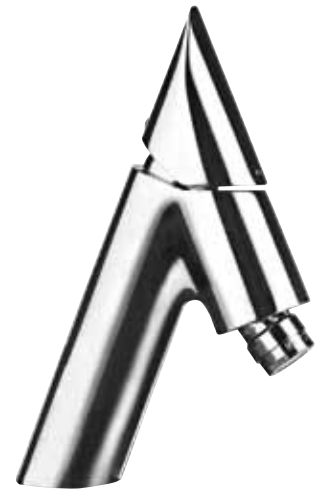

847

**ONE**





# ONE

29524



29529



29531/P



29531



**29524**

Monocomando doccia incasso.  
*Built-in shower mixer.*

**29529**

Monocomando incasso  
doccia con deviatore.  
*Built-in shower mixer  
with diverter.*

**29531**

Colonna doccia a pavimento  
completa di rubinetteria,  
deviatore e set doccia.  
*Floor shower column complete  
with taps, diverter and shower set.*

**29531/P**

Colonna doccia a muro completa  
di rubinetteria, deviatore e set doccia.  
*Wall shower column complete  
with taps, diverter and shower set.*



# MINI ONE



**41521**

Monocomando lavabo/bidet completo di scarico clic-clac.  
*Basin/bidet mixer with clic-clac waste.*

**41532/15**

Monocomando lavabo completo di prolunga cm. 15 e di scarico clic-clac.  
*Basin mixer with 15 cms. extension and clic-clac waste.*

**41532/20**

Monocomando lavabo completo di prolunga cm. 20 e di scarico clic-clac.  
*Basin mixer with 20 cms. extension and clic-clac waste.*

**41532/25**

Monocomando lavabo completo di prolunga cm. 25 e di scarico clic-clac.  
*Basin mixer with 25 cms. extension and clic-clac waste.*

**41532/30**

Monocomando lavabo completo di prolunga cm. 30 e di scarico clic-clac.  
*Basin mixer with 30 cms. extension and clic-clac waste.*

**41533**

Lavabo da pavimento.  
*Floor basin mixer column.*



41521

41532/15

41532/20

41532/25

41532/30

41533

# ONE COORDINATI

29001



29002



29009



29008



29007/30/40/60



**29001**  
Porta abito.  
*Robe hook.*

**29002**  
Asta sporgente.  
*Towel rail.*

**29009**  
Porta rotolo.  
*Toilet paper holder.*

**29008**  
Porta rotolo doppio.  
*Double toilet paper holder.*

**29007/30/40/60**  
Porta asciugamano cm. 30/40/60.  
*30/40/60 cms. towel rail.*

# ONE COORDINATI

29012



29014



29015



29023



29024



29020

29018



29021

**29012**  
Porta bicchiere appoggio.  
*Glass holder to lean.*

**29014**  
Porta bicchiere.  
*Glass holder.*

**29015**  
Porta sapone.  
*Soap holder.*

**29018**  
Porta sapone appoggio in ottone.  
*Brass soap holder to lean.*

**29023**  
Porta dispenser.  
*Soap dispenser.*

**29024**  
Porta dispenser appoggio.  
*Soap dispenser to lean.*

**29020**  
Mensola cm.11x70.  
*11x70 cms. bracket.*

**29021**  
Mensola cm.11x35.  
*11x35 cms. bracket.*

# ONE COORDINATI

29025



30030 - 30031



29050



29051



**29025**

Porta scopino.  
*Toilet brush holder.*

**29026**

Porta scopino a muro.  
*Toilet brush holder to the wall.*

**30031**

Lampada alogena  
lineare 220 volt.  
*220 volt halogen lamp.*

**30030**

Specchio cm. 100x60.  
*100x60 cms. mirror.*

**29050**

Piantana lavabo con  
porta sapone e porta  
asciugamano h. cm. 90.  
*90 cms. basin standard with  
soap holder and towel rail.*

**29051**

Piantana bidet con porta  
sapone, porta asciugamano  
e porta carta h. cm. 70.  
*70 cms. bidet standard with  
soap holder, towel rail  
and paper holder.*







# MOON

Marco Poletti design



# MOON

39521



39522

**39521**

Monocomando lavabo  
piletta clic-clac.  
*Basin mixer  
with clic-clac waste.*

**39522**

Monocomando bidet  
piletta clic-clac.  
*Bidet mixer  
with clic-clac waste.*



# MOON

**39524**

Monocomando doccia incasso.  
*Built-in shower mixer.*

**39529**

Monocomando doccia  
incasso con deviatore.  
*Built-in shower mixer  
with diverter.*

**848**

Soffione doccia.  
*Built-in shower head.*



39524



39529



848









# ALCOR

Bongio design

## 42521/BG

Monoforo lavabo con bocca girevole e scarico clic-clac.  
*Basin monobloc with swivel spout and clic-clac waste.*

42521/BG



42501



## 42522/BG

Monoforo bidet con bocca girevole e scarico clic-clac.  
*Bidet monobloc with swivel spout and clic-clac waste.*

42522/BG



42538/16/22



## 42538/16/22

Gruppo lavabo a parete con bocca cm. 16/22.  
*Wall basin mixer with 16/22 cms. spout.*

## 42503

Batteria bidet tre fori completa di scarico clic-clac.  
*Three holes bidet mixer with clic-clac waste.*

42503



**42501**

Batteria lavabo a tre fori  
completa di scarico clic-clac.

*Three holes basin mixer  
with clic-clac waste.*



**ALCOR**



**42527/D**

Gruppo vasca esterno  
su colonnette con doccia duplex.  
*External bath and shower mixer  
on pillar connection with  
duplex shower set.*

**42536/D**

Gruppo vasca esterno  
con doccia duplex.  
*External bath and shower  
mixer with duplex shower set.*

**42523**

Gruppo doccia esterno.  
*External shower mixer.*

**42528**

Gruppo vasca esterno su  
colonnette da terra con set doccia.  
*External bath and shower mixer  
on pillar connection to the floor  
with shower set.*

42527/D



42536/D

42523

42528

## 42531/D

Gruppo bordo  
vasca cinque fori.  
*Five holes deck bath  
and shower mixer.*

## 42530/D

Gruppo vasca incasso  
con doccia duplex.  
*Built-in bath and shower  
mixer with duplex shower set.*



42531/D



42530/D









# T CROSS

Bongio design



# T CROSS

## 30501

Batteria lavabo tre fori completa di scarico 1.1/4".  
*Three holes basin mixer with 1.1/4" pop-up waste.*

## 30501/BG

Batteria lavabo tre fori completa di scarico 1.1/4" e bocca girevole.  
*Three holes basin mixer with swivel spout and 1.1/4" pop-up waste.*

## 30503

Batteria bidet tre fori completa di scarico 1.1/4" e bocca.  
*Three holes bidet mixer with spout and 1.1/4" pop-up waste.*

## 30503/BG

Batteria bidet tre fori completa di scarico 1.1/4" e bocca girevole.  
*Three holes bidet mixer with swivel spout and 1.1/4" pop-up waste.*

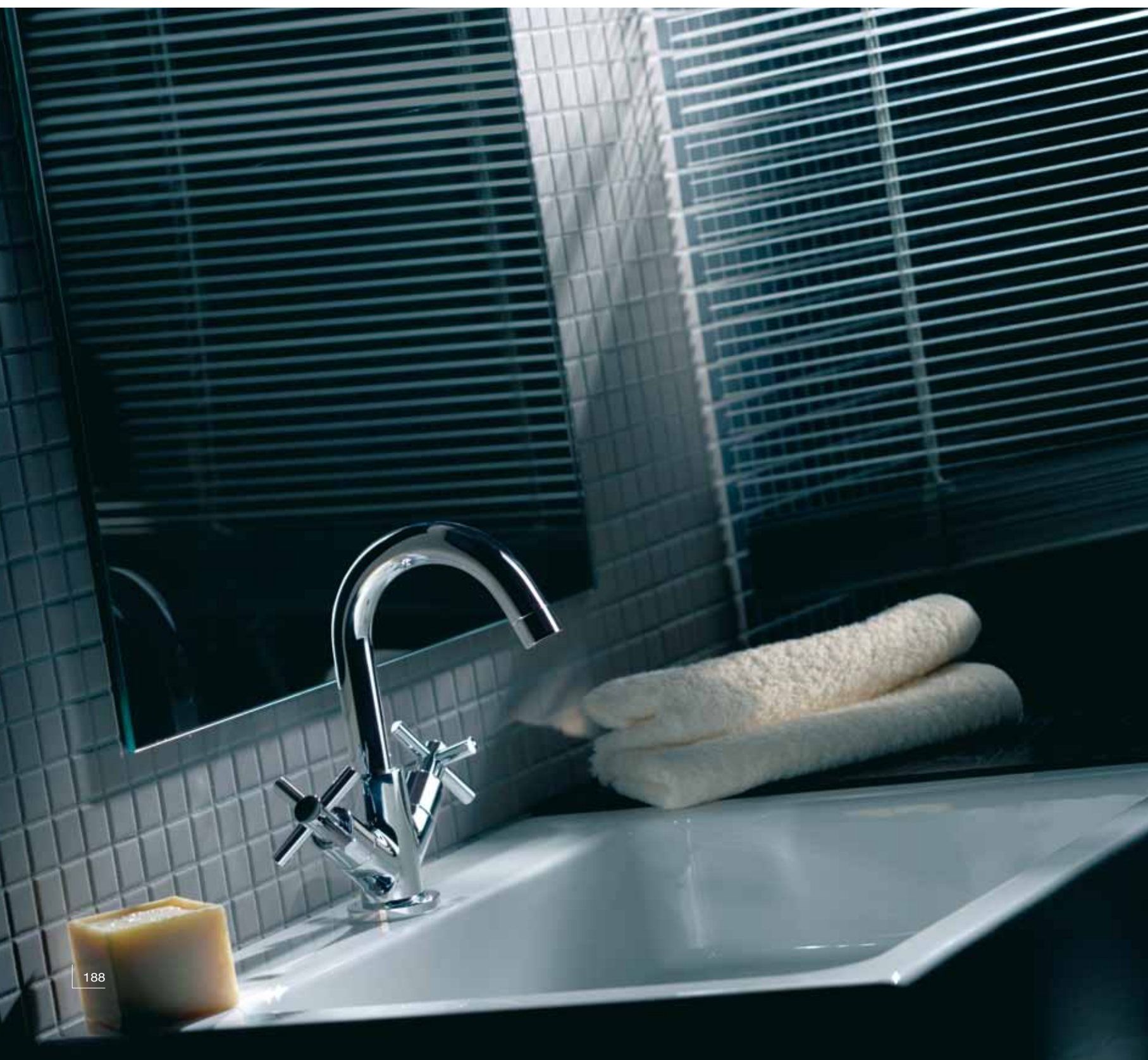

**30521**

Monoforo lavabo completo di scarico 1.1/4".  
*Basin monobloc with 1.1/4" pop-up waste.*

**30521/BG**

Monoforo lavabo completo di scarico 1.1/4" e bocca girevole.  
*Basin monobloc with swivel spout and 1.1/4" pop-up waste.*

**30522**

Monoforo bidet completo di scarico 1.1/4".  
*Bidet monobloc with 1.1/4" pop-up waste.*

**30522/BG**

Monoforo bidet completo di scarico 1.1/4" e bocca girevole.  
*Bidet monobloc with swivel spout and 1.1/4" pop-up waste.*

**30581**

Monoforo lavabo completo di scarico 1.1/4" e bocca alta girevole.  
*Basin monobloc with high swivel spout and 1.1/4" pop-up waste.*

**30538/16/22**

Gruppo lavabo a parete con bocca cm. 16/22.  
*Wall basin mixer with 16/22 cms. spout.*

**30538/1/2 A**

Idem ma completa di connessioni incasso.  
*Ditto complete with built-in connections.*

30501



30503



30521



30522



30581



30538/16/22

# T CROSS

## 30536/D

Gruppo vasca esterno  
con doccia duplex.

*External bath and shower  
mixer with duplex shower set.*

## 30523

Gruppo esterno per doccia.

*External shower mixer.*

## 30530/D

Gruppo vasca incasso  
con doccia duplex.

*Built-in bath and shower  
mixer with duplex shower set.*

30536/D



30523



30530/D





# T CROSS



**30537/D**

Gruppo doccia esterno  
con tubo, soffione e duplex.  
*External shower mixer with tube,  
shower head and duplex shower set.*

**30531/D**

Gruppo bordo  
vasca cinque fori.  
*Five holes deck bath  
and shower mixer.*



30531/D



30537/D

# T LEVER

Bongio design

## 31501

Batteria lavabo tre fori completa di scarico 1.1/4".  
*Three holes basin mixer with 1.1/4" pop-up waste.*

### 31501/BG

Batteria lavabo tre fori completa di scarico 1.1/4" e bocca girevole.  
*Three holes basin mixer with swivel spout and 1.1/4" pop-up waste.*

## 31521

Monoforo lavabo completo di scarico 1.1/4".  
*Basin monobloc with 1.1/4" pop-up waste.*

### 31521/BG

Monoforo lavabo completo di scarico 1.1/4" e bocca girevole.  
*Basin monobloc with swivel spout and 1.1/4" pop-up waste.*

## 31503

Batteria bidet tre fori completa di scarico 1.1/4" e bocca.  
*Three holes bidet mixer with spout and 1.1/4" pop-up waste.*

### 31503/BG

Batteria bidet tre fori completa di scarico 1.1/4" e bocca girevole.  
*Three holes bidet mixer with swivel spout and 1.1/4" pop-up waste.*

## 31522

Monoforo bidet completo di scarico 1.1/4".  
*Bidet monobloc with 1.1/4" pop-up waste.*

### 31522/BG

Monoforo bidet completo di scarico 1.1/4" e bocca girevole.  
*Bidet monobloc with swivel spout and 1.1/4" pop-up waste.*

31501



31503



31521



31522



# T LEVER

31581



31530/D

**31581**

Monoforo lavabo completo di scarico 1.1/4" e bocca alta girevole.  
*Basin monobloc with high swivel spout and 1.1/4" pop-up waste.*

**31538/16/22**

Gruppo lavabo a parete con bocca da cm. 16/22.  
*Wall basin mixer with 16/22 cms. spout.*

**31538/1A/2A**

Idem ma completa di connessioni incasso.  
*Ditto complete with built-in connections.*

**31536/D**

Gruppo vasca esterno con doccia duplex.  
*External bath and shower mixer with duplex shower set.*

**31530/D**

Gruppo vasca incasso con doccia duplex.  
*Built-in bath and shower mixer with duplex shower set.*

**31523**

Gruppo esterno per doccia.  
*External shower mixer.*

**31531/D**

Gruppo bordo vasca cinque fori.  
*Five holes deck bath and shower mixer.*

31536/D



31523

31531/D

# T MIX

Bongio design

32521



32532



32522



32538/16/22



32526/D



32523



**32521**

Monocomando lavabo completo di scarico 1.1/4".  
*Basin mixer with 1.1/4" pop-up waste.*

**32532**

Monocomando lavabo completo di prolunga cm. 15 e di scarico 1.1/4".  
*Basin mixer with extension 15 cms. and 1.1/4" pop-up waste.*

**32522**

Monocomando bidet completo di scarico 1.1/4".  
*Bidet mixer with 1.1/4" pop-up waste.*

**32538/16/22**

Monocomando lavabo a parete con bocca da cm. 16/22.  
*Wall basin mixer with 16/22 cms. spout.*

**32526/D**

Monocomando vasca esterno con doccia duplex.  
*External bath & shower mixer with duplex shower set.*

**32523**

Monocomando doccia esterno.  
*External shower mixer.*

# T MIX



## **32529**

Monocomando doccia  
incasso con deviatore.  
*Built-in shower mixer  
with diverter.*

## **32544-CL**

Miscelatore termostatico  
coassiale 1/2" incasso doccia,  
piastra minimalista.  
*Coaxial 1/2" built-in thermostatic  
shower mixer minimalist plate.*

## **32531/D**

Gruppo bordo vasca.  
*Deck bath and  
shower mixer.*

## **32549-CL**

Miscelatore termostatico  
coassiale 1/2" incasso doccia,  
con deviatore, piastra minimalista.  
*Coaxial 1/2" built-in thermostatic  
shower mixer minimalist plate with  
diverter.*

32529



32544-CL

**32524**

Monocomando doccia incasso.  
*Built-in shower mixer.*

**32544**

Miscelatore termostatico 1/2" incasso doccia, piastra minimalista.  
*1/2" built-in thermostatic shower mixer minimalist plate.*

**32525**

Deviatore 3 vie.  
*3 ways diverter.*

**32547/D**

Termostatico doccia esterno con tubo, soffione e doccia duplex.  
*External thermostatic shower mixer with tube, shower head and duplex shower set.*



32524

32531/D



32544



32549-CL



32525/3



32547/D

# T ELETTRONICO



**30501/EL**

Bocca erogazione con  
sistema elettronico.  
*Erogation spout with  
electronical system.*

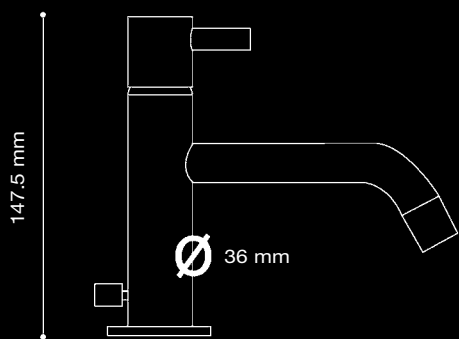

### T MINI MIX

**34521**  
Monocomando lavabo s.a. 1.1/4".  
Basin mixer 1.1/4" waste.

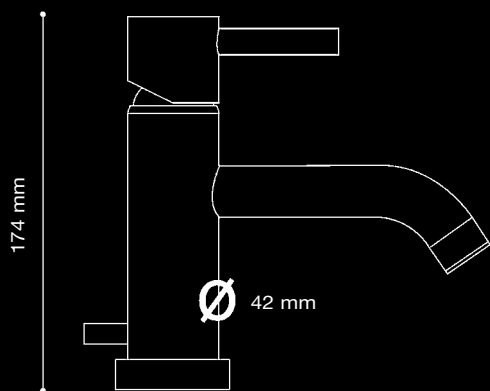

### T MIX

**32521**  
Monocomando lavabo s.a. 1.1/4".  
Basin mixer 1.1/4" waste.

T MIX

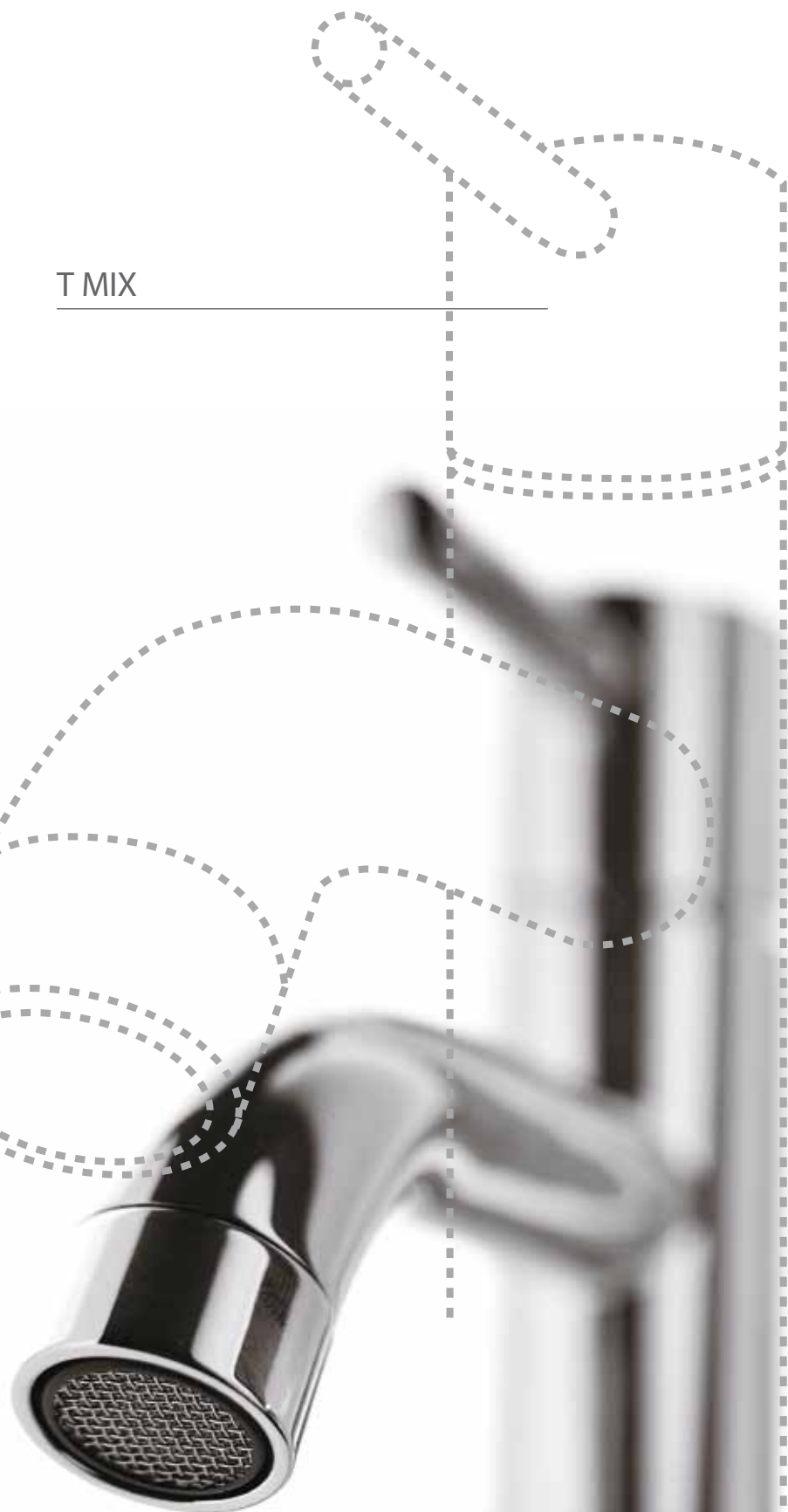

T MINI MIX

# T MINI MIX

Bongio design

## 34521

Monocomando lavabo completo di scarico 1.1/4".  
*Basin mixer with 1.1/4" pop-up waste.*

## 34522

Monocomando bidet completo di scarico 1.1/4".  
*Bidet mixer with 1.1/4" pop-up waste.*

## 34532

Monocomando lavabo completo di prolunga cm 15 e scarico 1.1/4".  
*Basin mixer with extension 15 cms and 1.1/4" pop-up waste.*

34521



34532



34522



34539/16/22



34538/16/22



34534/D

**34539/16/22**

Monocomando lavabo a parete con piastra e bocca da cm. 16/22 completa di scatola incasso acciaio.

*Wall basin mixer with 16/22 cms. spout, plate and built-in stainless steel box.*

**34534/D**

Gruppo bordo vasca quattro fori con cartuccia progressiva.

*Four holes deck bath and shower mixer with progressive cartridge.*

**34538/16/22**

Monocomando lavabo a parete con bocca da cm. 16/22.

*Wall basin mixer with 16/22 cms. spout.*



# T SQUARE

Bongio design



52521



**52521**

Monocomando lavabo completo di scarico 1.1/4".  
*Basin mixer with 1.1/4" pop-up waste.*

**52532**

Monocomando lavabo completo di prolunga cm 15 e scarico 1.1/4".  
*Basin mixer with extension 15 cms and 1.1/4" pop-up waste.*

**52522**

Monocomando bidet completo di scarico 1.1/4".  
*Bidet mixer with 1.1/4" pop-up waste.*

**52544**

Termostatico incasso coassiale.  
*Coaxial built-in thermostatic mixer.*

**52549**

Termostatico incasso coassiale con deviatore.  
*Coaxial built-in thermostatic mixer with diverter.*

**52524**

Miscelatore doccia incasso.  
*Built-in shower mixer.*

**52529**

Miscelatore doccia incasso con deviatore.  
*Built-in shower mixer with diverter.*

**52525/3**

Deviatore 3-vie.  
*3-ways diverter.*

52532

52544

52524



52529



52522

52549

52525/3

# T LEVA LATERALE

Bongio design



**32581**

Monocomando lavabo completo di scarico 1.1/4" e bocca bassa girevole.  
*Basin mixer with short swivel spout and 1.1/4" pop-up waste.*

**32582**

Monocomando bidet completo di scarico 1.1/4" e bocca girevole.  
*Bidet mixer with swivel spout and 1.1/4" pop-up waste.*

**32533**

Lavabo a pavimento.  
*Floor basin mixer column.*

**32583**

Monocomando lavabo completo di scarico 1.1/4" e bocca alta girevole.  
*Basin mixer with high swivel spout and 1.1/4" pop-up waste.*

**32534**

Colonna vasca da pavimento con miscelatore, set doccia, deviatore.  
*Bath column to the floor with mixer, shower set, diverter.*

32581



32583



32582



32533



32534



# T JOY

Bongio design



# T JOY

33521



33532



33522



33526/D



33523

**33521**

Monocomando lavabo completo di scarico 1.1/4".  
*Basin mixer with 1.1/4" pop-up waste.*

**33526/D**

Monocomando vasca esterno con duplex.  
*External bath & shower mixer with duplex set.*

**33532**

Monocomando lavabo completo di prolunga cm. 15 e di scarico 1.1/4".  
*Basin mixer with extension 15 cms. and 1.1/4" pop-up waste.*

**33523**

Monocomando doccia esterno.  
*External shower mixer.*

**33522**

Monocomando bidet completo di scarico 1.1/4".  
*Bidet mixer with 1.1/4" pop-up waste.*



# T COORDINATI

## **30000**

Rosone a muro Ø mm. 30.  
*Wall flange 30 mms. Ø.*

## **30001**

Porta abito.  
*Robe hook.*

## **30003**

Porta abito doppio.  
*Double robe hook.*

## **30007/30/40/50/60/80**

Porta asciugamano  
cm. 30/40/50/60/80.  
*30/40/50/60/80 cms.  
towel rail.*

## **30008/30/40/50/60/80**

Porta asciugamano  
cm. 30/40/50/60/80  
con portasapone.  
*3030/40/50/60/80 cms.  
towel rail with soap holder.*

## **30009**

Porta rotolo.  
*Toilet paper holder.*





30000



30001



30003



30007/30/40/50/60/80



30008/30/40/50/60/80



30009

# T COORDINATI

**30015**

Porta sapone.  
*Soap holder.*

**30016**

Porta sapone con doppio supporto.  
*Soap holder with double support.*

**30023**

Porta dispenser con doppio supporto.  
*Soap dispenser with double support.*

30015



30016



30023



30024



30012



30018



**30014**

Porta bicchiere.  
*Glass holder.*

**30013**

Porta bicchiere con doppio supporto.  
*Glass holder with double support.*

**30028**

Porta sapone appoggio.  
*Soap holder to lean.*

**30024**

Porta dispenser appoggio con base.  
*Soap dispenser to lean with base.*

**30012**

Porta bicchiere appoggio con base.  
*Glass holder to lean with base.*

**30018**

Porta sapone appoggio con base.  
*Soap holder to lean with base.*

**30027**

Porta dispenser appoggio.  
*Soap dispenser to lean.*

**30022**

Porta bicchiere appoggio.  
*Glass holder to lean.*

**30025**

Porta scopino.  
*Toilet brush holder.*

**30026**

Porta scopino a muro.  
*Toilet brush holder to the wall.*

30014



30013



30028



30027



30022



30025/30026



# T COORDINATI

**30020**

Mensola cm. 11x70.  
*11x70 cms. bracket.*

**30030**

Specchio cm. 100x60.  
*100x60 cms. mirror.*

**30031**

Lampada alogena  
lineare 220 volt.  
*220 volt halogen lamp.*

**30017**

Cestello rettangolare.  
*Rectangular basket.*

**30011**

Cestello ad angolo.  
*Angle basket.*

**30021**

Cestello ad angolo doppio.  
*Double angle basket.*

30020



30030/30031



30017

30011

30021



# T COORDINATI



## 30055

Piantana a muro h. cm. 40  
composta da porta sapone,  
porta asciugamano e porta rotolo.  
*40 cms. wall bracket with soap  
holder, towel rail and paper holder.*

## 30054

Piantana a muro h. cm. 70  
composta da porta sapone, porta  
bicchiere, 2 porta asciugamani  
e specchio a lente TOP.  
*70 cms. wall bracket with soap  
holder, glass holder, 2 towel rails  
and TOP magnifying mirror.*

## 30053

Piantana regolabile composta da  
portasapone, porta asciugamano,  
porta carta e porta scopino.  
*Adjusting standard with soap  
holder, towel rail, paper  
holder and toilet brush holder.*

## 30052

Piantana regolabile composta  
da portasapone e due porta  
asciugamano.  
*Adjusting standard with soap  
holder and two towel rails.*



30055



30054



30053



30052







# AQUA

Bongio design



# AQUA

## 40501

Batteria lavabo tre fori completa di scarico clic-clac.  
*Three holes basin mixer with clic-clac waste.*

## 40503

Batteria bidet tre fori completa di scarico clic-clac e bocca.  
*Three holes bidet mixer with clic-clac waste.*

## 40521/BG

Monoforo lavabo con bocca girevole e scarico clic-clac.  
*Basin monobloc with swivel spout and clic-clac waste.*

## 40522/BG

Monoforo bidet con bocca girevole e scarico clic-clac.  
*Bidet monobloc with swivel spout and clic-clac waste.*

## 40538/16/22

Gruppo lavabo a parete con bocca cm. 16/22.  
*Wall basin mixer with 16/22 cms. spout.*

40501

40503



40521/BG

40522/BG

40538/16/22



# AQUA



40536/D

**40554**

Gruppo vasca esterno  
con doccia duplex.  
*External bath and shower  
mixer with duplex shower set.*

**40554/R**

Termostatico incasso da  
3/4" senza chiusura.  
*3/4" built-in thermostatic  
shower mixer without lock.*

**40536/D**

Gruppo vasca esterno  
con doccia duplex.  
*External bath and shower  
mixer with duplex shower set.*

**40527/D**

Gruppo vasca esterno  
su colonnette con doccia duplex.  
*External bath and shower mixer  
on pillar connection with  
duplex shower set.*

**40523**

Gruppo doccia esterno.  
*External shower mixer.*

**40528**

Gruppo vasca esterno su  
colonnette da terra con set doccia.  
*External bath and shower mixer  
on pillar connection to the floor  
with shower set.*

40554



40554/R



40527/D



40523



40528

# AQUA

985/70/90



40531/D



**985/70**

Bocca pavimento h. mm.900,  
AQUA.

*Spout to the floor, 900 mms. long,  
AQUA.*

**985/90**

Bocca pavimento h. mm.1150,  
AQUA.

*Spout to the floor, 1150 mms. long,  
AQUA.*

**40531/D**

Gruppo bordo vasca  
cinque fori con doccia.

*Five holes deck bath  
and shower mixer.*

**40530/D**

Gruppo vasca incasso  
con doccia duplex.

*Built-in bath and shower  
mixer with duplex shower set.*



40530/D













# MIRO'

Marco Poletti design





26521



26522

**26521**

Monocomando lavabo  
completo di scarico 1.1/4".  
*Basin mixer with 1.1/4"*  
*pop-up waste.*

**26522**

Monocomando bidet  
completo di scarico 1.1/4".  
*Bidet mixer with 1.1/4"*  
*pop-up waste.*





**26526/D**

Monocomando vasca  
esterno con doccia duplex.  
*External bath and shower  
mixer with duplex shower set.*

**26523**

Monocomando doccia esterno.  
*External shower mixer.*

**26529**

Monocomando doccia  
incasso con deviatore.  
*Built-in shower mixer  
with diverter.*

**26524**

Monocomando doccia incasso.  
*Built-in shower mixer.*



26526/D

26523



26529

26524

# MIRO' COORDINATI

26000



26001



26002



26004



26007/4/6



26008/4/6

**26000**

Gancia.  
*Hook set.*

**26004**

Porta asciugamani ad anello.  
*Towel ring holder.*

**26001**

Porta abito gancio a spalliera.  
*Robe hook.*

**26007/4/6**

Porta asciugamano cm. 40/60.  
*40/60 cms. towel rail.*

**26002**

Porta asciugamani  
a due aste girevoli.  
*Towel rail with  
2 movable arms.*

**26008/4/6**

Porta asciugamano  
cm. 40/60.con portasapone:  
*40/60 cms. towel rail  
with soap holder.*

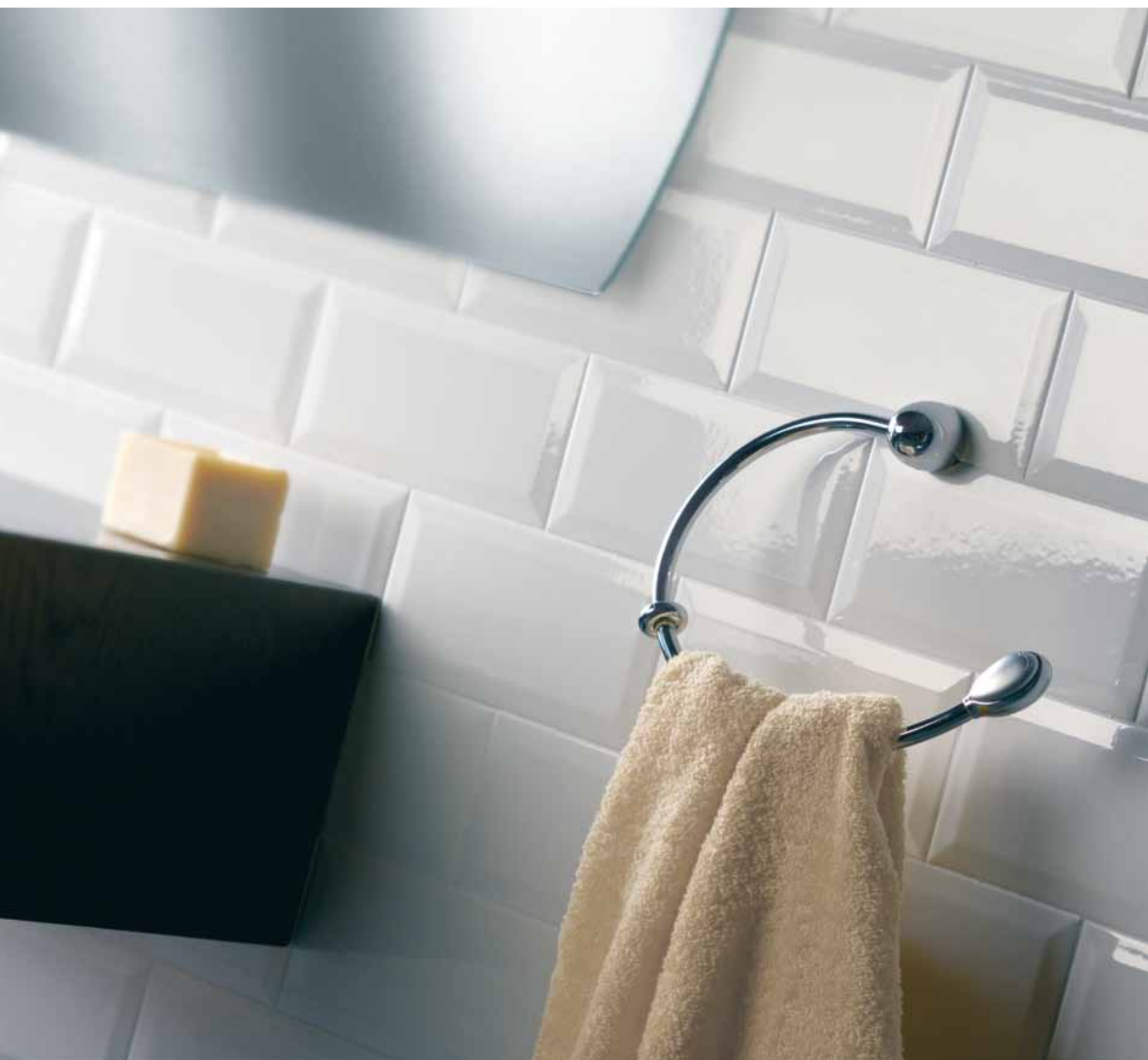

# MIRO' COORDINATI

26009



26014



26015



26012



26018



26024

26023



26017



26016



26011

**26009**

Porta rotolo.  
*Toilet paper holder.*

**26014**

Porta bicchiere.  
*Glass holder.*

**26015**

Porta sapone.  
*Soap holder.*

**26023**

Porta dispenser.  
*Soap dispenser.*

**26017**

Porta sapone e bicchiere.  
*Soap and glass holder.*

**26016**

Porta sapone doppio.  
*Double soap holder.*

**26012**

Porta bicchiere appoggio.  
*Glass holder to lean.*

**26018**

Porta sapone appoggio.  
*Soap holder to lean.*

**26024**

Porta dispenser appoggio.  
*Soap dispenser to lean.*

**26011**

Porta sapone e porta bicchiere appoggio.  
*Soap and glass holder to lean.*

# MIRO' COORDINATI

26019



26022



26028



26026



26020



26021



**26019**

Porta sapone  
doppio appoggio.  
*Double soap  
holder to lean.*

**26020**

Mensola cm. 13x62.  
*13x62 cms. bracket.*

**26022**

Porta bicchiere  
appoggio con base.  
*Glass holder to  
lean with base.*

**26021**

Mensola cm. 16x30.  
*16x30 cms. bracket.*

**26028**

Porta sapone  
appoggio con base.  
*Soap holder  
to lean with base.*

**26025**

Porta scopino.  
*Toilet brush holder.*

**26026**

Porta dispenser  
appoggio con base.  
*Soap dispenser to  
lean with base.*

**26030**

Specchio cm. 95x70.  
*95x70 cms. mirror.*



26025



26030/26031



# MIRO' COORDINATI

Cromo  
Chrome



Oro  
Gold



Cromo Satinato  
Matt Chrome



Oro Satinato  
Matt Gold



Blu  
Blue



Verde Muschio  
Musk Green



Verde Cedro  
Cidrum Green



Rosso  
Red



Bianco Satinato  
Matt White



**26052**

Piantana regolabile composta da portasapone e due porta asciugamani.

*Adjusting standard with soap holder and two towel rails.*

**26053**

Piantana regolabile composta da porta sapone, porta asciugamano, porta rotolo e porta scopino.

*Adjusting standard with soap holder, towel rail, toilet paper holder and toilet brush holder.*

**26054**

Piantana a muro h. cm. 70 composta da specchio a lente TOP, porta bicchiere, porta sapone e due porta asciugamani.

*70 cms. wall bracket with TOP magnifying mirror, glass holder, soap holder and two towel rails.*

**26055**

Piantana a muro h. cm. 50 composta da porta sapone, porta asciugamano e porta carta.

*50 cms. wall bracket with soapholder, towel rail and paper holder.*

26054



26052



26053



26055





936





# 936

## **36501**

Batteria lavabo tre fori completa di scarico 1.1/4".  
*Three holes basin mixer with 1.1/4" pop-up waste.*

## **36503**

Batteria bidet tre fori completa di scarico 1.1/4" e bocca.  
*Three holes bidet mixer with spout and 1.1/4" pop-up waste.*

## **36502**

Batteria bidet tre fori completa di scarico 1.1/4".  
*Three holes bidet mixer with 1.1/4" pop-up waste.*

## **36521**

Monoforo lavabo completo di scarico 1.1/4".  
*Basin monobloc with 1.1/4" pop-up waste.*



36501



36503



36502



36521

36522



36538/16/22



36581



36536/D



36523



**36522**

Monoforo bidet completo di scarico 1.1/4".

*Bidet monobloc with 1.1/4" pop-up waste.*

**36538/16/22**

Gruppo lavabo a parete con bocca da cm. 16/22.

*Wall basin mixer with 16/22 cms. spout.*

**36581**

Monoforo lavabo completo di scarico 1.1/4" e bocca alta girevole.

*Basin monobloc with high swivel spout and 1.1/4" pop-up waste.*

**36536/D**

Gruppo vasca esterno con duplex.

*External bath and shower mixer with duplex set.*

**36523**

Gruppo esterno per doccia.

*External shower mixer.*



36531/D



36530/D



36537/D

**36531/D**

Gruppo bordo  
vasca cinque fori.  
*Five holes deck bath  
and shower mixer.*

**36530/D**

Gruppo vasca incasso  
con doccia duplex.  
*Built-in bath and shower mixer  
with duplex shower set.*

**36537/D**

Gruppo doccia esterno con tubo,  
soffione e doccia duplex.  
*External shower mixer with tube,  
shower head and duplex shower set.*



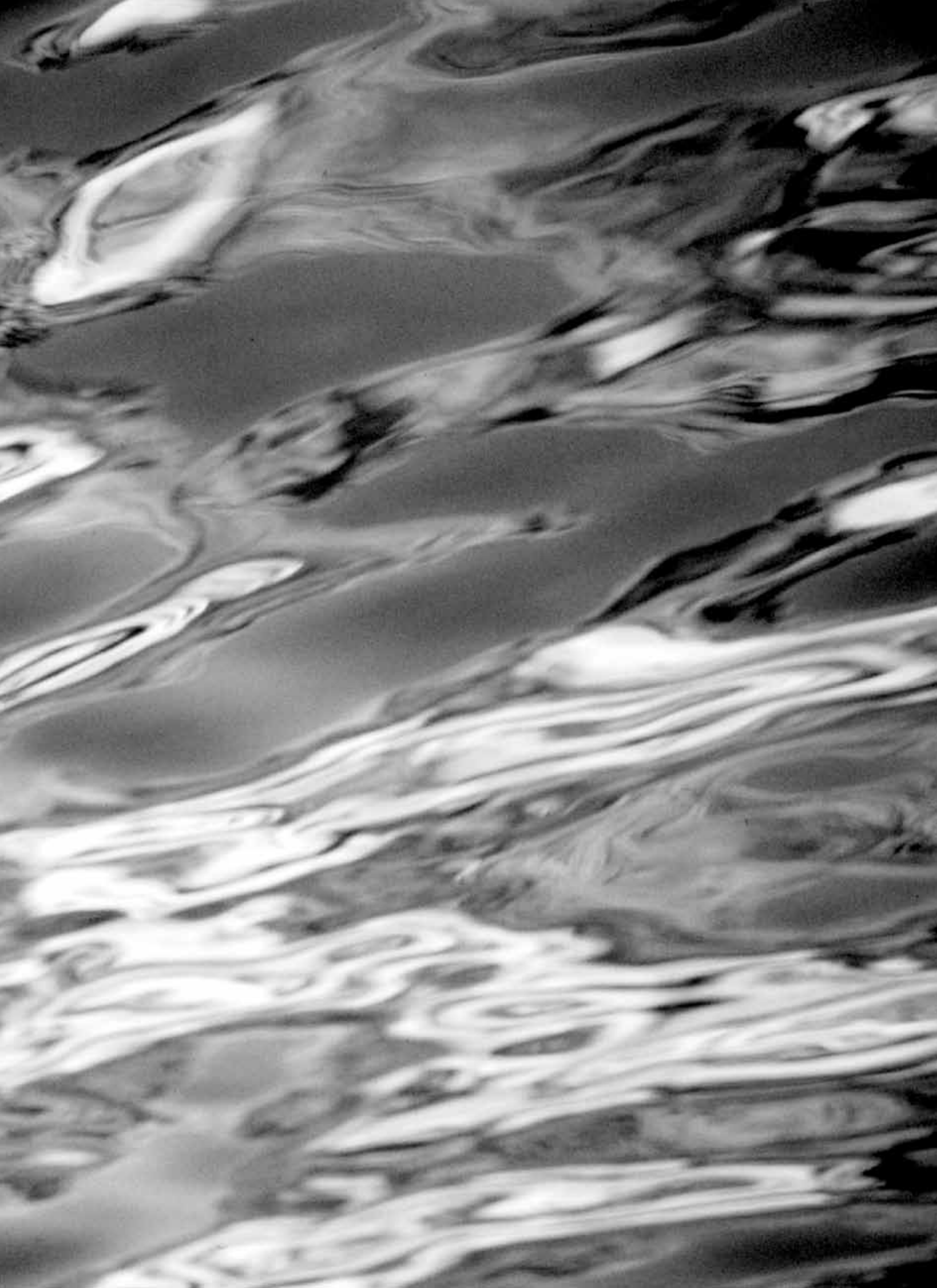





# PAT

Bongio design



# PAT

**21001**

Porta abito.  
*Robe hook.*

**21004**

Porta asciugamano ad anello.  
*Towel ring holder.*

**21007/30/40/50/60/80**

Porta asciugamano  
cm. 30/40/50/60/80.  
*30/40/50/60/80 cms.  
towel rail.*

**21009**

Porta rotolo.  
*Toilet paper holder.*

**21015**

Porta sapone.  
*Soap holder.*

21001

21004



21007/30/40/50/60/80

21009

21015





**PAT**



**21023**

Porta dispenser.  
*Soap dispenser.*

**21014**

Porta bicchiere.  
*Glass holder.*

**21020**

Mensola cm. 14x64.  
*14x64 cms. bracket.*

**21025**

Porta scopino.  
*Toilet brush holder.*

**21030**

Specchio tondo Ø cm. 8.  
*80 cms. Ø round mirror.*

**30031**

Lampada alogena  
lineare 220 volt.  
*220 volt halogen lamp.*

21023

21014



21020

21025

21030 - 30031

**21055**

Piantana a muro h. cm. 40  
composta da porta sapone,  
porta asciugamano e porta rotolo.  
*40 cms. wall bracket with soap  
holder, towel rail and paper  
holder.*

**21053**

Piantana bidet h. cm. 78  
composta da portasapone,  
porta asciugamano,  
porta carta e porta scopino.  
*78 cms. bidet standard with  
soap holder, towel rail, paper  
holder and toilet brush holder.*

**21052**

Piantana lavabo h. cm. 93  
composta da portasapone  
e due porta asciugamano.  
*93 cms. basin standard with  
soap holder and two towel rails.*

**21054**

Piantana a muro h. cm. 80  
composta da porta sapone,  
porta bicchiere, 2 porta  
asciugamani e specchio a lente.  
*80 cms. wall bracket with soap  
holder, glass holder, 2 towel rails  
and magnifying mirror.*



21052



21053



21054



21055





# BRASIL & HOTELERIE

Bongio design





# BRASIL & HOTELERIE

4001



4002



4004



4007/30/40/50/60



4008



4009



30011



30021

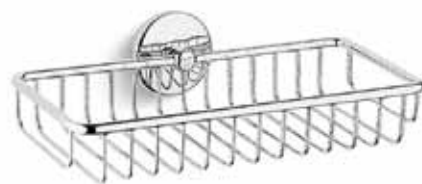

4013

**4001**

Porta abito.  
*Robe hook.*

**4008**

Porta rotolo con ribalta.  
*Toilet paper holder with flap.*

**30021**

Cestello ad angolo doppio.  
*Double angle basket.*

**4002**

Porta asciugamano  
a due aste girevoli.  
*Towel rail with  
2 movable arms.*

**4009**

Porta rotolo.  
*Toilet paper holder.*

**4013**

Cestello rettangolare.  
*Rectangular basket.*

**4004**

Porta asciugamano ad anello.  
*Towel ring holder.*

**4010**

Porta rotolo di riserva.  
*Toilet paper holder with supply.*

**4007/30/40/50/60**

Porta asciugamano  
cm. 30/40/50/60.  
*30/40/50/60 cms. towel rail.*

**30011**

Cestello ad angolo.  
*Angle basket.*

4010

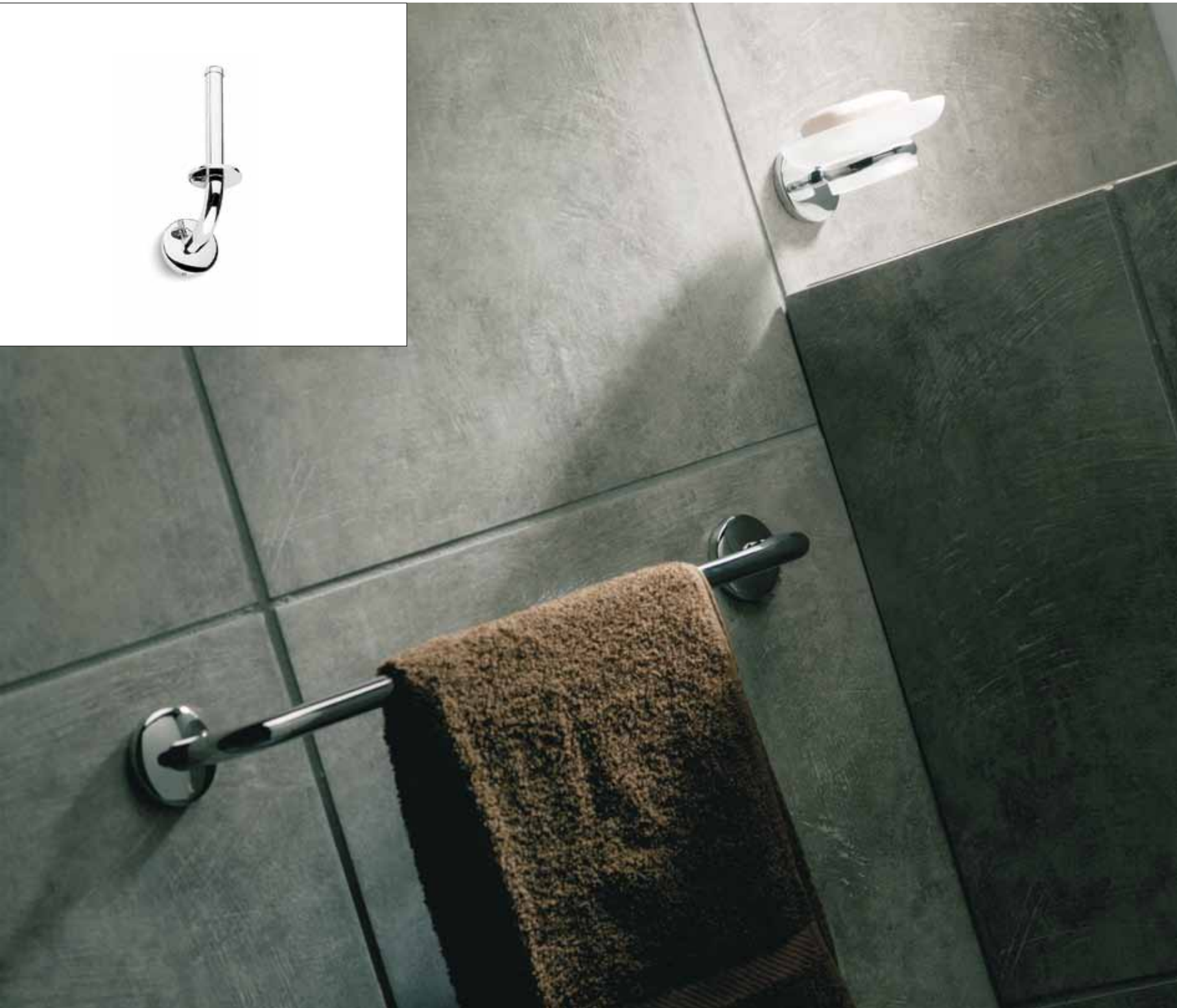

# BRASIL & HOTELERIE

4015



4014



4020/70

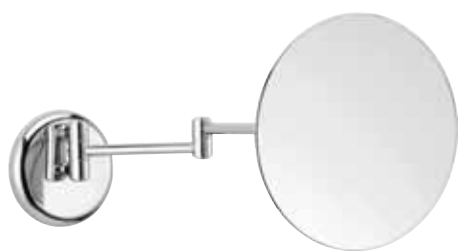

4042/M



4042/LM



4101



4103



4105



4106

15025



21025



30026

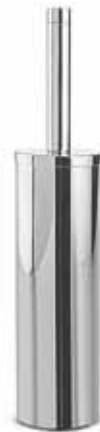

4102



4104 / 4104/S

**4015**

Porta sapone.  
*Soap holder.*

**4014**

Porta bicchiere.  
*Glass holder.*

**4020/70**

Mensola cm. 12x70.  
*12x70 cms. bracket.*

**15025**

Porta scopino con vaso  
in vetro satinato.  
*Toilet brush holder  
with matt glass.*

**21025**

Porta scopino.  
*Toilet brush holder.*

**30026**

Porta scopino a muro.  
*Toilet brush holder to the wall.*

**4042/M**

Specchio ingranditore a muro  
con braccio doppio Ø 21 cm.  
*d.21 mirror to the wall  
with double arm.*

**4042/LM**

Specchio ingranditore a  
muro con braccio doppio  
e luce Ø 21 cm.  
*d.21 mirror to the wall with  
double arm and LIGHT.*

**4101**

Griglia porta teli.  
*60 cms. Towel shelf.*

**4102**

Porta rifiuti con coperchio  
a pedale 3 lt.  
*3 lt. Trash bin.*

**4104**

Maniglione per vasca.  
*Grab-bar for bath tub  
without soap holder.*

**4104/S**

Maniglione per vasca con  
cestino porta sapone.  
*Grab-bar for bath tub with  
soap holder.*

**4103**

Contenitore porta fazzoletti  
muro/appoggio in acciaio.  
*Wall kleenex dispenser.*

**4105**

Filo stendibiancheria.  
*Retractable clothes line.*

**4106**

Distributore da muro/appoggio  
per sacchetti igienici.  
*Wall/lean sanitary bags  
dispenser.*





# CUCINA

Bongio design

**32580**

Monocomando lavello leva laterale.  
*Sink mixer.*

**32680**

Monocomando lavello con  
bocca e doccetta estraibili.  
*Sink mixer with extractable  
spout and handshower.*

**32280**

Monocomando lavello.  
*Sink mixer.*

32580



32680



32280



32380



32980



51680





32180

**32380**

Monocomando lavello  
con doccetta estraibile.  
*Sink mixer with extractable  
handshower.*

**51680**

Monocomando lavello con  
bocca e doccetta estraibili.  
*Sink mixer with extractable  
spout and handshower.*

**32980**

Monocomando lavello  
con mollettone.  
*Sink mixer with spring.*

**32180**

Monocomando lavello in acciaio.  
*Stainless steel sink mixer.*

# CUCINA



**30580**

Monoforo lavello.  
*Sink monobloc.*

**45580**

Monoforo lavello.  
*Sink monobloc.*

**31580**

Monoforo lavello.  
*Sink monobloc.*

**15580**

Monoforo lavello.  
*Sink monobloc.*

**36580**

Monoforo lavello.  
*Sink monobloc.*

30580



31580



36580



45580



15580

# CUCINA

## 30570

Gruppo lavello a parete.  
*Wall sink mixer.*

## 31570

Gruppo lavello a parete.  
*Wall sink mixer.*

## 36570

Gruppo lavello a parete.  
*Wall sink mixer.*

## 36570/S

Gruppo lavello a parete  
con porta sapone.  
*Wall sink mixer  
with soap holder.*

## 15570

Gruppo lavello a parete.  
*Wall sink mixer.*

30570

31570



36570

36570/S

15570



SEE YOU...





# CERTIFICATO

## L'Organismo di Certificazione TÜV Rheinland Italia S.r.l.

certifica, in accordo alle procedure TÜV Rheinland Group, che l'azienda

**Mario Bongio S.r.l.**

**Via A. Moro, 2**

**I - 28017 San Maurizio D'Opaglio (NO)**

ha istituito ed attua un sistema di gestione per la qualità  
relativo al seguente campo di applicazione:

**Progettazione e produzione di rubinetteria sanitaria. EA 18**

Mediante un audit, rapporto N° 0460603, è stata conseguita  
dimostrazione che il sistema di gestione per la qualità è conforme alla Norma

**UNI EN ISO 9001:2008**

Fare riferimento al Manuale della Qualità per  
i dettagli sulle esclusioni rispetto ai requisiti della norma.

N° di registrazione del certificato: **39 00 0460603.**

Il presente certificato è valido dal 26/11/2010 al 28/12/2013.

La data di riferimento per le verifiche di sorveglianza annuali è (giorno/mese): 17/12

**Milano, li 26/11/2010.** Prima Certificazione: 28/12/2001

Il responsabile della Certificazione  
TÜV Rheinland Italia S.r.l., Via E. Mattei, 10 - I - 20010 Pogliano Milanese (MI)

**SINCERT**  
CERTIFICAZIONE QUALITÀ PERMANENTE E CERTIFICAZIONE

SGQ N° 003A  
Membro degli Accordi di Mutuo Riconoscimento EA ed IAF  
Signatory of EA and IAF Mutual Recognition Agreements

www.tuv.com

TÜVRheinland®

# CONDIZIONI GENERALI DI VENDITA

IL PRESENTE CATALOGO ANNULLA E SOSTITUISCE I PRECEDENTI. LE INFORMAZIONI IN ESSO CONTENUTE POSSONO SUBIRE VARIAZIONI SENZA ALCUN PREAVVISO.

Le presenti condizioni generali disciplinano tutti gli attuali e futuri contratti fra le parti, salvo eventuali deroghe concordate per iscritto. Eventuali condizioni generali del compratore non troveranno applicazione nei rapporti futuri tra le parti se non espressamente accettate per iscritto dalla Mario Bongio srl.

## 1. Formazione del contratto

L'invio da parte del compratore di un ordine al venditore comporta l'applicazione al contratto di vendita delle presenti condizioni generali. Il venditore si riserva il diritto di accettare o rifiutare l'ordine ricevuto. Le offerte fatte da agenti, rappresentanti ed ausiliari del commercio del venditore non sono per lui impegnative fino a quando non siano confermate dal venditore stesso.

## 2. Prezzi

Ai prezzi indicati nel listino deve essere applicata l'I.V.A. secondo l'aliquota in vigore al momento della fatturazione.

Il venditore si riserva di modificare i prezzi, o variare il listino prezzi senza alcun preavviso.

## 3. Resa della merce

Salvo patto contrario, la fornitura dei prodotti si intende Franco Fabbrica del venditore: trasporto ed assicurazione sono pertanto a carico del compratore e ciò anche quando sia convenuto che la spedizione o parte di essa venga curata dal venditore, nel qual caso quest'ultimo agirà come mandatario del compratore, essendo inteso che il trasporto verrà effettuato a rischio del compratore. I rischi relativi alla fornitura passano al compratore al momento in cui i prodotti lasciano lo stabilimento del venditore.

## 4. Termini di consegna

I termini di consegna indicati sulle conferme d'ordine, si intendono approssimativi a favore del venditore e comunque con un congruo margine di tolleranza. E' esclusa qualsiasi responsabilità del venditore per danni derivanti da anticipata, ritardata o mancata consegna, totale o parziale.

Il compratore è sempre tenuto a prendere in consegna i prodotti, anche in caso di consegne parziali e quando i prodotti vengano consegnati prima o successivamente alla data di consegna stabilita. Il termine di consegna verrà prorogato di un periodo pari a quello della durata dell'impedimento al verificarsi di cause di forza maggiore. In nessun caso, a causa del verificarsi di tali circostanze, il compratore potrà esigere compensi o indennizzi di qualsiasi natura.

## 5. Garanzia

Il venditore garantisce la conformità dei prodotti forniti; con il termine di conformità dei prodotti si intende che essi corrispondono per qualità, quantità e tipo a quanto stabilito nel contratto e che sono esenti da vizi che potrebbero renderli non idonei all'uso cui sono destinati. La garanzia per vizi è limitata ai soli difetti dei prodotti conseguenti a difetti di progettazione, di materiale o di costruzione riconducibili al venditore, e non si applica nel caso in cui il compratore non abbia effettuato una corretta conservazione dei prodotti e li abbia modificati senza il consenso del venditore. Il venditore non risponde dei difetti di conformità dei prodotti dovuti all'usura normale di quelle parti che, per loro natura sono soggette a usura rapida e continua. Per ogni altra precisazione si rimanda al libretto di garanzia presente nei nostri articoli.

## 6. Reclami

Il compratore è tenuto a verificare la conformità dei prodotti e l'assenza di vizi. I reclami relativi a non conformità dei prodotti forniti dovranno essere effettuati, a pena di decadenza, entro e non oltre cinque giorni dal ricevimento della merce a destino. I vizi, difetti o non conformità occulti devono essere denunciati immediatamente alla loro scoperta e comunque, a pena di decadenza, entro e non oltre i tre mesi dalla data di consegna. Tutti i reclami devono essere effettuati mediante lettera raccomandata

indirizzata al venditore e devono indicare dettagliatamente i vizi e le non conformità contestate.

## 7. Rimedi

In caso di prodotti non conformi, e dopo aver ricevuto un rapporto dettagliato dal compratore, il venditore potrà, a sua insindacabile scelta:

a) fornire gratuitamente Franco Fabbrica al compratore prodotti dello stesso genere e quantità di quelli risultanti difettosi o non conformi a quanto pattuito, dopo averne ottenuto la resa per la verifica. L'eventuale sostituzione effettuata prontamente dal venditore non può essere ritenuta un implicito riconoscimento dei vizi contestati. Qualora il venditore, in sede di verifica, non riconosca viziati i prodotti, provvederà alla fatturazione di quelli inviati in sostituzione; oppure

b) emettere una nota di accredito a favore del compratore per un importo corrispondente al valore dei prodotti difettosi.

In entrambi i casi il venditore ha diritto alla restituzione dei prodotti difettosi, che diventano di sua proprietà.

## 8. Limitazione di responsabilità del venditore

Salvo dolo o colpa grave del venditore l'eventuale risarcimento di qualsiasi danno al compratore non potrà comunque superare il prezzo di fattura dei prodotti contestati.

## 9. Resi

I resi di merce da parte dei committenti dovranno sempre comunque essere autorizzati per iscritto dalla nostra sede. I resi preventivamente autorizzati devono giungere alla fornitrice franco magazzino di San Maurizio d'Opaglio in buon ordine e negli imballaggi originali. L'accredito per le merci rese sarà stilato ad avvenuta presa in carico del nostro magazzino e controllo. Danni ai prodotti ed agli imballaggi saranno defalcati dall'accredito.

## 10. Pagamento

I pagamenti ed ogni altra somma dovuta a qualsiasi titolo al venditore si intendono netti al suo domicilio. Qualsiasi ritardo o irregolarità nel pagamento dà al venditore il diritto di sospendere le forniture o di risolvere contratti in corso, anche non relativi ai pagamenti in questione, nonché il diritto al risarcimento degli eventuali danni. Il venditore ha altresì il diritto a decorrere dalla scadenza del pagamento, agli interessi moratori nella misura stabilita in Italia dall'art. 5 del Decreto Legislativo 9 ottobre 2002 n. 231. Il ritardo nei pagamenti dà altresì al venditore il diritto di escludere la garanzia per tutto il periodo durante il quale il ritardo perdura.

## 11. Riserva di proprietà

I prodotti consegnati restano di proprietà del venditore sino al momento del completo pagamento del prezzo.

## 12. Legge applicabile e foro competente

Tutti i contratti disciplinati dalle presenti condizioni generali sono regolati dalla legge italiana.

Per ogni controversia relativa o comunque collegata a contratti cui si applicano le presenti condizioni generali è esclusivamente competente il foro del venditore; quest'ultimo avrà tuttavia facoltà di agire presso il foro del compratore.

## 13. Importo minimo ordini

A causa della notevole incidenza dei costi amministrativi non saranno presi in considerazione ordini di importo inferiore a € 100,00. Per ordini da € 100,00 a € 150,00 viene richiesto un contributo spese forfettario di € 15,00 per ogni spedizione.

## 14. Immagini

Le illustrazioni del catalogo sono una rappresentazione di ogni articolo ma non costituiscono impegno di fedele esecuzione. L'azienda si riserva il diritto di effettuare modifiche sia tecniche che estetiche senza preavviso, come pure procedere alla eliminazione di singoli articoli o di serie complete.



# GENERAL CONDITION FOR SALE

THIS CATALOGUE REPLACES THE PREVIOUS EDITIONS. THE DETAILS THEREIN CONTAINED MAY CHANGE WITHOUT PRIOR NOTICE.

This general conditions regulate all present and future sales contracts between the parties, subject to any exceptions specifically agreed upon in writing. Any general conditions of the purchaser will not apply to future contractual relations between the parties unless expressly accepted in writing by Mario Bongio srl.

## 1. Formation of the Contract

The purchaser placing the order fully accepts the application of these general terms to the Contract for sale. Seller reserves the right to accept or refuse it. Offers made by Agents, representatives or auxiliaries of the seller do not bind him until they are confirmed by the seller itself.

## 2. Prices

The prices indicated in the price list do not include V.A.T or any other tax whatsoever. Seller may modify the prices/ price list without prior notice.

## 3. Delivery of the goods

Unless agreed to the contrary, the supply of the products has intended ex-factory: transport and insurance are therefore at the charge of the purchaser, this also when it has been decided that the delivery or part of it will be taken care of, by the seller, in which case the latest will act as the purchaser's agent, it being understood that the transport will be carried out at the expense and risk of the purchaser. The risks relative to the supply pass to the purchaser, at the latest at the time in which the products leave the seller's plant.

## 4. Delivery time of the goods

The delivery limits on the order confirmations are agreed approximately in favour of the seller and not binding for him. Any liability of the seller has excluded for damage deriving from anticipated, delayed or non delivery, total or partial.

The purchaser has always held to take delivery of the products, even in the case of partial deliveries and even when the products have been consigned before the established delivery date or successively to that date. The seller shall not be deemed to be in breach of this agreement, or otherwise be liable to the purchaser, by reason of any delay in delivery, to the extent that the delay is due to any Force Majeure, and the time for performance of delivery shall be extended accordingly.

## 5. Guarantee

The seller guarantees the compliance of the products supplied; the term compliance of the products means the products correspond in quality, quantity and type to what has been agreed in the contract and that they are without defects that could render them unfit for the use to which they are intended to be put. The guarantee against defects has limited only to product defects due to defects in planning, materials or construction that can be attributed to the seller, and it does not apply in the case where the purchaser is unable to prove a correct preservation of the product and where he has modified them without the agreement of the seller. The seller is not liable for defects in product compliance due to the normal wear of those parts which, by nature, are subject to rapid and continuous wear and tear. See the warranty book enclosed in our packaging for other specifications.

## 6. Claims

The purchaser has to control the compliance of the products and the absence of flaws. Claims relevant to non-conformities of the goods must be made, on pain of forfeiture, within and not later than five days from the goods arrival at their place of destination. Hidden flaws, defect or non-compliances must be reported immediately after the discovery and in any event, on pain of forfeiture, not later than three months from the delivery date. Claims must be made by registered letter addressed to the seller and must describe in detail the flaws or disputed non-compliances.

## 7. Remedies

In case of faulty products and following to a report by the purchaser, the seller may at his discretion:

- supply ex-factory to the purchaser products of the same kind and quantity as those that proved not in compliance, on receiving returns for checking. Any replacement carried out promptly by the seller cannot be considered as implicit recognition of defects claimed: said recognition must always be explicit and following control by seller on goods challenged; should the seller, on controlling, find the goods in compliance, he will invoice for those sent in replacement; or
- issue to the purchaser a credit-note in the amount equal to the value of the defective products.

In both cases the purchaser shall return the faulty products to the seller.

## 8. Limit of the seller's liability

Except in the case of fraud or gross negligence on the seller's part, compensation of any damage to the purchaser will not, in any event, be greater than invoice price of the disputed products.

## 9. Returned goods

The purchaser needs a written authorization from the seller to return the goods.

The authorized returned goods will be free our warehouse in San Maurizio d'Opaglio. The credit note for the returned goods will be defined after the arrival and inspection of our quality / technical department. Damages to the products or to the packaging will be deducted from the credit note.

## 10. Payments

The payment and every other sum due to the seller, are understood as net at the registered office of the seller. Any delay or irregularity in the payment gives the seller the right to suspend the supply or to cancel the contract in case, even if they are not relevant to the payments in question as well as the right to compensation for eventual damages. The seller has also the right – starting from the payment deadline – to interests for delay as per art. 5 of Italian Legislative Decree no. 231 of 09/10/2002. The delays of payment likewise give the seller the right to exclusion from guarantee, for the whole period that the delay may persist.

## 11. Retention of Title

The delivered products remain the seller's property until the moment of the complete payment of the price.

## 12. Applicable Law and Competent Law-Court

All Contracts ruled by these general conditions are submitted to Italian Law. For any controversy relative to, or connected to the contractual products to which this general conditions apply, the seller's Law-Court has exclusive competence; the latest, however, will have the opportunity to act also in the purchaser's Law-Court.

## 13. Minimum value for the order

Due to the growing administration cost orders under a value of 100,00 euros will not be taken into consideration. A contribution of a fixed amount of 15,00 euros will be charged on all the orders with a total value between 100,00 and 150,00 euros.

## 14. Images

Images of our catalogue are a representation of each item but they must not be considered as perfect reproductions. Our company keeps the right to make technical and aesthetical modifications without any previous communication, as well as the right to cancel from the production single items or complete series.

Le illustrazioni dei nostri prodotti non costituiscono impegno di fedele esecuzione  
Our products illustrations are not pledge of faithful execution



Die Armaturen T CROSS,  
MYAMYX und STEALTH  
sind nicht verfügbare fuer  
den deutschen Markt.

Print Tipolitografia Testori

Edizione maggio 2012

**bongio**<sup>®</sup>  
Made in Italy dal 1936

**MARIO BONGIO SRL**

Via Aldo Moro, 2  
C.P. 108  
28017 S. Maurizio  
d'Opaglio (NO) - ITALY  
Tel. +39 0322 967248  
Fax +39 0322 950012

[www.bongio.it](http://www.bongio.it)  
[info@bongio.it](mailto:info@bongio.it)

**MADE IN ITALY**

**Water**<sup>®</sup>

L'acqua non è finita ma non è infinita.

[www.bongio.it](http://www.bongio.it)



**bongio**<sup>®</sup>